



EVOLUTION® Series Add-On: Precision™ Soil Sensor

Introduction

Congratulations on purchasing Toro's new EVOLUTION® controller with the Precision™ Soil Sensor add-on. With the Precision™ Soil Sensor add-on, you will quickly realize savings in both time and money while keeping your garden healthy and beautiful.

Specifications

- Power Supply: 4.5 VDC supplied by three size-AA alkaline batteries
- Housing Material: High-impact, UV-resistant ABS
- Moisture Protection: Electronic circuitry encased in solid epoxy; battery compartment sealed by O-ring
- Signal Quality Indicator: Tri-colored (Red, Yellow, Green) LED
- Stainless steel electrodes
- Built-in installation anchor stakes
- RF reception range: 500' (152 m) LOS (line of sight)
- Operating Temperature: 14° F – 131° F (-10°C to +55°C)

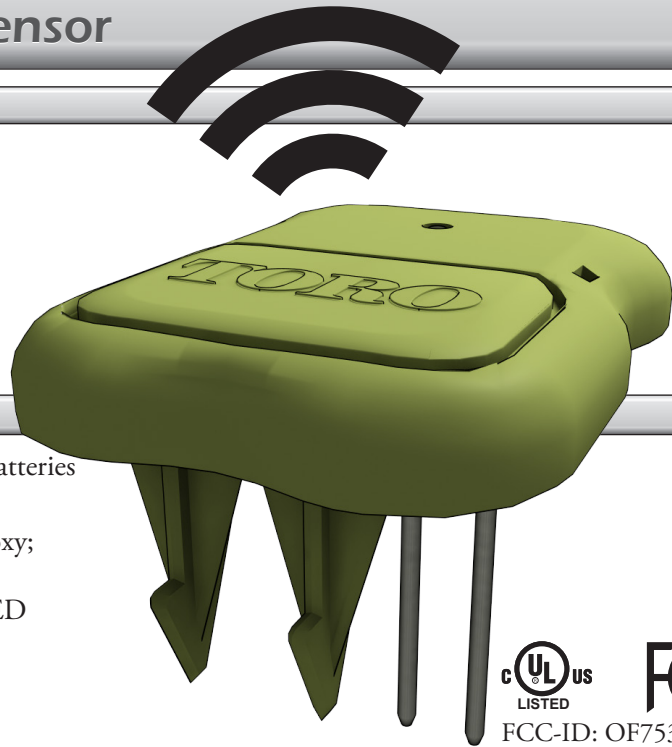

FCC-ID: OF753851

IC: 3575A-53851

Table of Contents

Specifications	1	Fine Tuning the Moisture Level	8
Overview	3	Signal Strength	9
		Battery Level	9
Installation	4	Calibrate	9
EVOLUTION® Smart Connect®	4	Cal Setting	9
Precision™ Soil Sensor	4	Current Temperature	10
Battery Installation	4	Freeze Off	10
		ID	10
Sensor Setup	5		
Add the Sensor to the Controller	5	Review Screen	11
Install and Calibrate the Sensor	6	Appendix A: The Low Threshold Setting	11
Soil Sensor Menu	7	Appendix B: Site Selection and Earth Installation	12
Navigating the Menu Interface	7	FCC Statement	13
Getting to the Sensors Menu	7	Toro Support	14
Menu Settings	8		
Moisture Now	8		
Low Threshold	8		

Overview

The Precision™ Soil Sensor Add-On works with the EVOLUTION® Smart Connect® receiver. It is possible to add up to three soil sensors per controller.

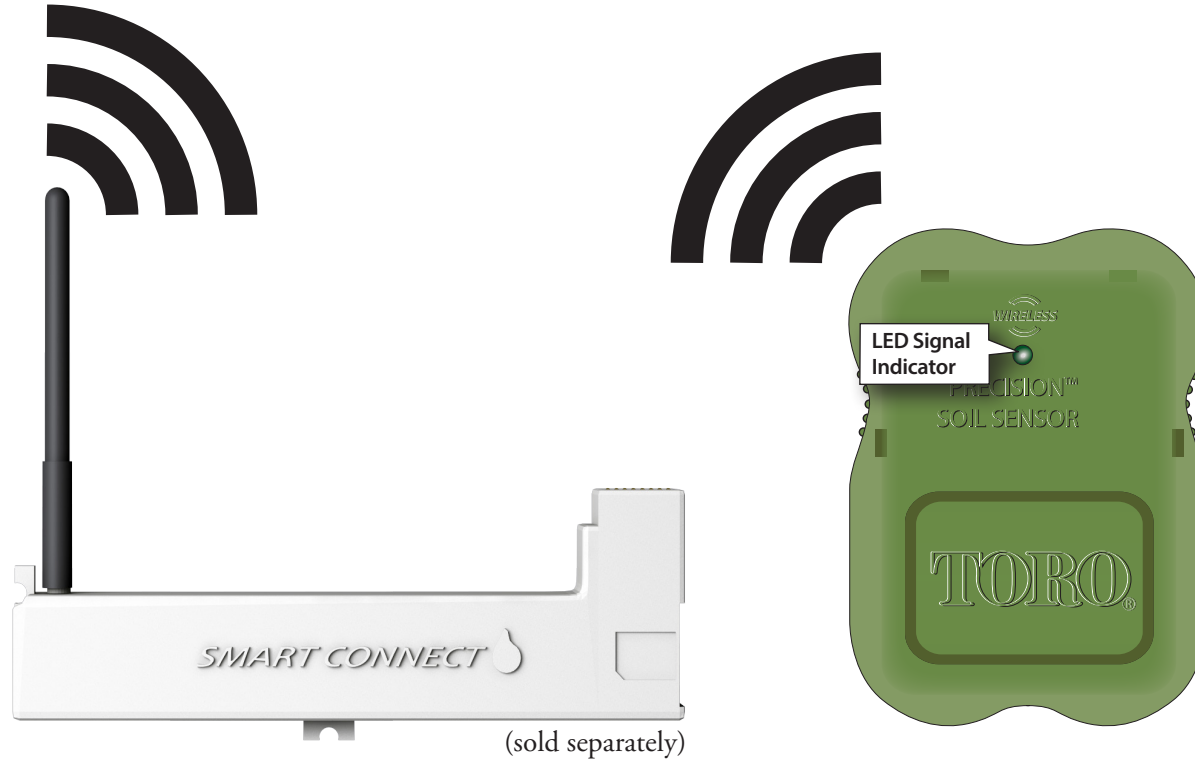

Installation

EVOLUTION® Smart Connect®

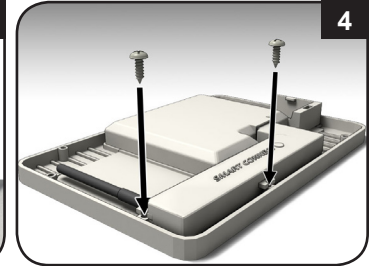
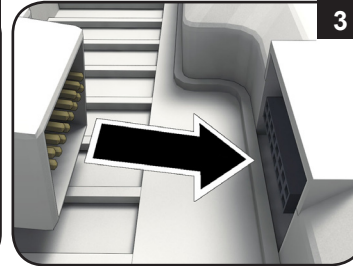
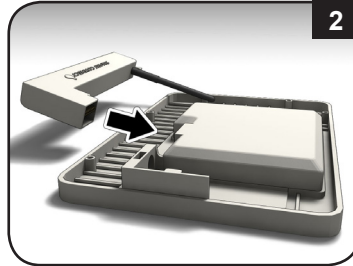
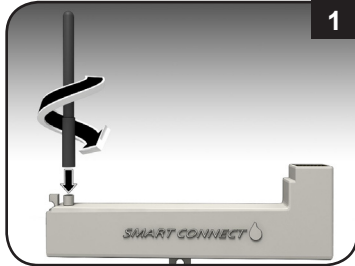

Precision™ Soil Sensor Battery Installation

The Soil Sensor works on three “AA” Alkaline or Lithium batteries (not included).

1. Remove four Phillips screws securing the sensor battery compartment cover (**Figure 1**). Set cover aside.
2. Install the batteries (**Figure 2**).
3. Ensure the O-ring is in place then install the battery compartment cover.

 When batteries are initially installed, the LED signal indicator is red. When the receiver links with the sensor, the LED changes to green. The LED will remain on for 30 minutes to facilitate sensor installation.

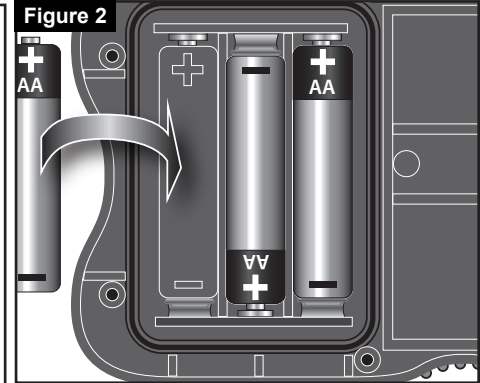
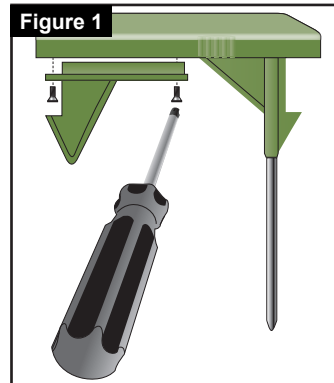

Sensor Setup

Implement the following two procedures to successfully setup Toro's Precision™ Soil Sensor:

1. "Add" the sensor to the controller for successful wireless communication.
2. Calibrate the sensor for proper irrigation operation.

1. Add the Sensor to the Controller

Every soil sensor has a unique ID number. That number must be "added" to the controller.

1. Press  **ADVANCED** then .

2.  to **ADD/REMOVE DEVICE**.

 to confirm.

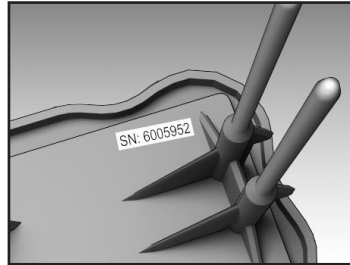

3.  to **SOIL 1**.  to **ADD**.  to confirm.

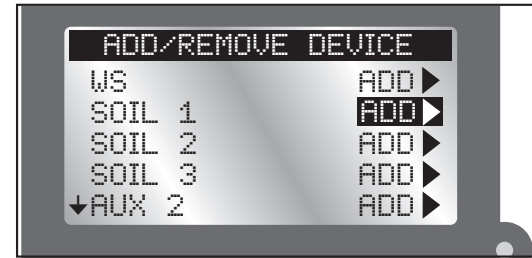

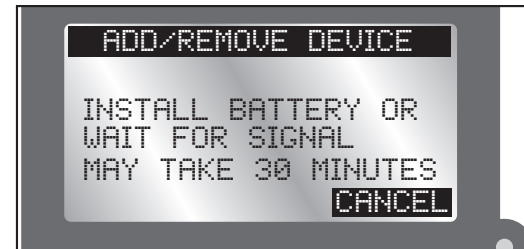

4. The EVOLUTION® controller waits for the identification signal from the soil sensor.

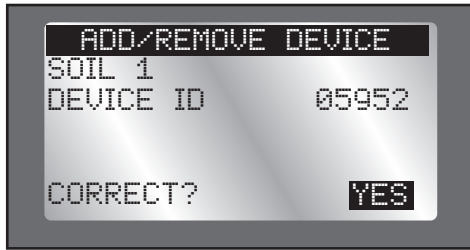

- If the soil sensor has had batteries installed *in the last 30 minutes*, the controller should detect and add the sensor immediately.
- If the sensor is out in the field, it could take up to a half an hour to detect and add the sensor.
- One can remove and reinstall the soil sensor's batteries to achieve immediate sensor detection.

5. The controller will detect the soil sensor. Confirm that the sensor ID detected matches the sensor's SN ID.



6. If it does match, press  and continue to **Calibrate the Sensor**.
If it does *not* match, change YES to NO, press , and repeat steps 3-5.







2. Install and Calibrate the Sensor

The Precision™ Soil Sensor interprets soil moisture content on a scale of 0% (extremely dry) to 100% (very wet). The key to understanding how to calibrate a soil sensor is that *the operator must teach the 100% moisture level to the sensor*.

1. After selecting YES from the previous screen, follow the onscreen instructions below. Install the soil sensor in the ground.

(See **Appendix B: Site Selection and Earth Installation** for complete instructions on good sensor location.)





-  If soil sensor is not installed in the ground within that 30 minute “window”, the controller removes the sensor and installation will have to be redone.
 2. Return to the controller and confirm that the signal strength (see above graphic) is good. If signal strength is weak, relocate the sensor to a spot closer to the controller.
 3. Press  when satisfied. Use the  and  to adjust the calibration setting (default 5: approximately a 1-day “watch window”). Press .
-  The “Cal Setting” number adjusts the time it takes to calibrate the sensor. A Cal Setting of ‘0’ calibrates the sensor to the *current* moisture level in the ground. The

calibration will be set using the next sensor reading (within 30 minutes).

Additional calibration settings are available. From '1' (~1 day "watch window") to '168' (~7 day "watch window").









4. Move to the YES field after CALIBRATE NOW? Press . Sensor calibration begins.
5. Press  to return to the Home screen. A message on the bottom of the Home screen indicates that the sensor is calibrating. The message clears when calibration is finished.



The Soil Sensor Menu

The EVOLUTION® controller's Soil Sensor menu displays sensor information as well as allows the user to modify certain settings.

Navigating the Menu Interface

- Use  or  to navigate the menu commands.
- To change a value, press  or  to move to the desired field, then press  and  to adjust the value.
- Press  to input the desired value.

Getting to the Sensors Menu

1. Press  **ADVANCED** then .
2. Press  to **SENSORS**. Press .



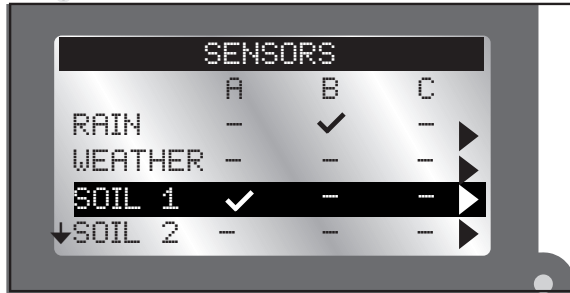

3. Press  to select the desired soil sensor.



4. **To add a sensor to a schedule:**

Press  or  to select the desired Schedule (A, B, or C).

Press  or  to make the sensor active for the selected schedule.

- ✓: Sensor is active.
- : Sensor is disabled.

 In the screen above, a rain sensor is assigned to schedule B and a soil sensor to schedule A.

5. Press  until the Soil Sensor menu appears.

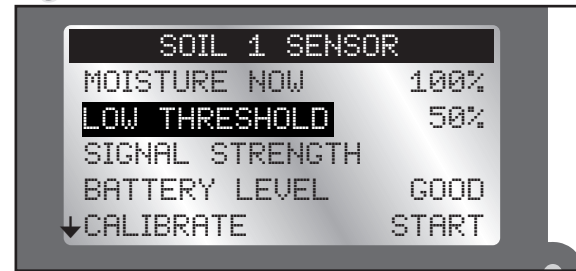

Menu Settings

MOISTURE NOW

This displays the current moisture level, as a percentage, of the soil. 100% is the soil level set after the first calibration (see **Calibrate the Sensor**, page 6).



LOW THRESHOLD

This is the point at which the soil sensor will let the controller resume irrigation of the landscape. If you were to compare the soil to a gas tank, the “low threshold” would be the point at which you refill the gas tank.

 For a detailed explanation of the low threshold setting, please read **Appendix A** of this manual.

Fine-tuning the “Low Threshold” Moisture Level

Changes to the 50% setting should be made initially in 5% increments in order to see results within a few days. The objective is to find the moisture setting that results in a mild stress condition in the lawn, indicated by slight wilting and dryness. At that point, adjust the setting 5% in the opposite direction. This should result in moisture maintenance level that’s very close to optimum.

1. Press  or  to increase or decrease the Low Threshold point by 1%.
2. Press  to input the desired value.

SIGNAL STRENGTH

Indicates signal strength as a series of bars (▬▬▬).





BATTERY LEVEL

Indicates the battery strength in the soil sensor.

CALIBRATE

Calibration is required to establish the maximum amount of usable moisture in the soil. The sensor will then recognize this soil moisture level as the maximum capacity (100%). From this fixed reference point, the sensor determines when the soil moisture has dropped enough (to the “Low Threshold”) to allow watering.

Manual calibration: At some point, it might be necessary to recalibrate the sensor (in the event of a sensor relocation for example).

1. Run an automatic or manual watering operation to thoroughly irrigate the sensor zone.
2. Go to the Sensor Menu of the soil sensor to calibrate.
3. Press  to CAL SETTING. Use  to move to the number field. Use  or  to adjust the calibration number (default 5: approximately a 1-day “watch window”). Press  to confirm.

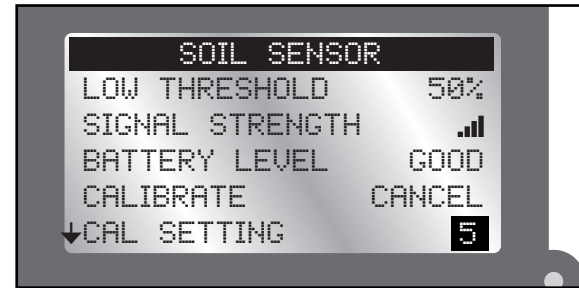

 The “Cal Setting” number adjusts the time it takes to calibrate the sensor. A Cal Setting of ‘0’ calibrates the sensor to the *current* moisture level in the ground. The calibration will be set using the next sensor reading (within 30 minutes).

Additional calibration settings are available. From ‘1’ (-1 day “watch window”) to ‘168’ (-7 day “watch window”).

4. Press  to CALIBRATE.  to START.
 to confirm.

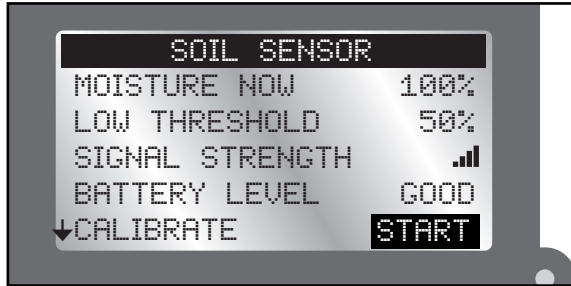

5. **START** will turn to **CANCEL**.



Over the specified time period (see note above), the soil sensor will “learn” the 100% mark and transmit that information to the controller. At the end of the time period, soil sensor calibration is done.

6. If you have not already directed the soil sensor to control a schedule (page 8), please do so now.

FREEZE OFF AT

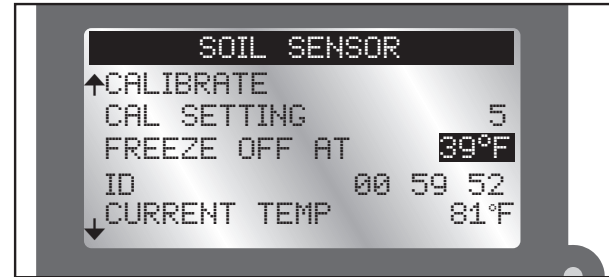
Freeze Off is the temperature at which irrigation will be turned off due to cold temperatures.



1.  or  raises or lowers the temperature value.
2. Press  to input the value.

ID



Displays the ID of the selected soil sensor.

CURRENT TEMP

Displays the temperature of the sensor at ground level (*not* at “spike” level).

Review Screen

The Review screen allows operators to review settings for the various sensors added to the controller.

1. Press the  Review button.
2. Press  to the SOIL SENSOR. Press .

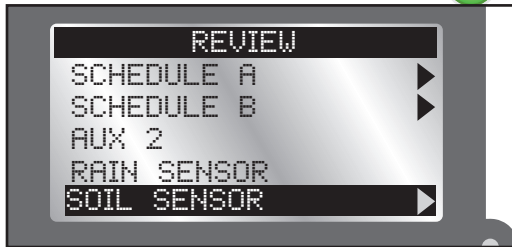

3. Use  to scroll through the various sensor settings.

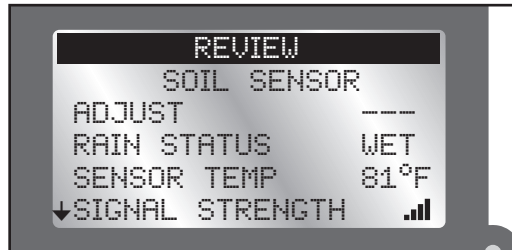

Appendix A: The Low Threshold Setting

Landscape plants are the heartiest when their roots become established several inches down where water is stored for the longest period of time. Watering often, for short periods of time, promotes root growth near the top of the soil, where the moisture evaporates quickly.

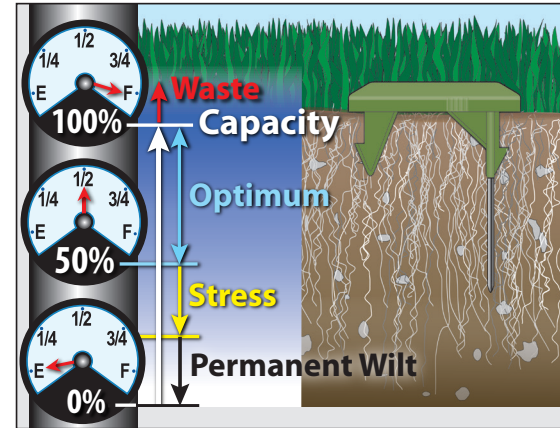

The key to maintaining healthy plants with minimum water waste is to water thoroughly—only when it's needed. The Precision™ Soil Sensor is preset to restrict watering until the soil moisture level drops to 50% of capacity, or 1/2 of the total moisture that can be retained in the soil. If you were to draw a comparison to a car's fuel tank, 50% of the soil moisture capacity would be similar to using 1/2 of the fuel in the tank before stopping to refill. A 50% setting restricts the sprinklers from refilling the soil to capacity until 1/2 of the moisture has been lost; causing the roots to go deeper for water. With the capability to adjust the setting incrementally from 0% to 100%, the Precision Soil Sensor can be fine-tuned for virtually any soil condition.

Appendix B: Site Selection and Earth Installation

Site Selection

Choosing the right location for the sensor is important for the overall effectiveness of the Precision Soil Sensor system.

The below graphic represents a typical residential landscape. 'X' indicate good locations for sensor placement.

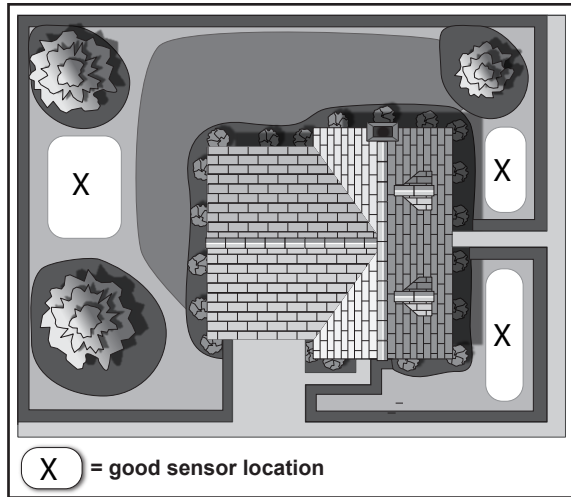

For your garden, make sure the site selected is:

- representative of the overall soil type and condition
- the highest elevation
- not over a septic tank or drain field

- well within receiver communication range (500' line-of-sight)
- at least 4 feet away from a driveway, roof overhang or downspout
- not in a footpath or recreational area
- not exposed to overspray from nearby watering zones

Earth Installation

1. Move the sensor to the proposed installation site.
Signal strength is indicated by the LED color as follows:

- Green = Excellent
- Yellow = Acceptable
- Red = Not Acceptable - Relocate Sensor

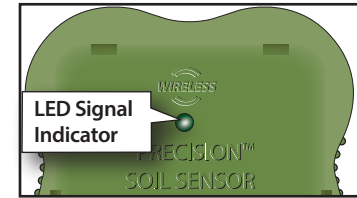

2. Thoroughly irrigate the sensor location and surrounding landscape area. *This step is crucial to establish the "100%" moisture level for sensor calibration.*
3. Trim the grass close to ground level where the sensor will be placed.



For close-cut turf varieties, such as Hybrid Bermuda, the top of the sensor must be installed at grade level to prevent damage by mowing equipment.

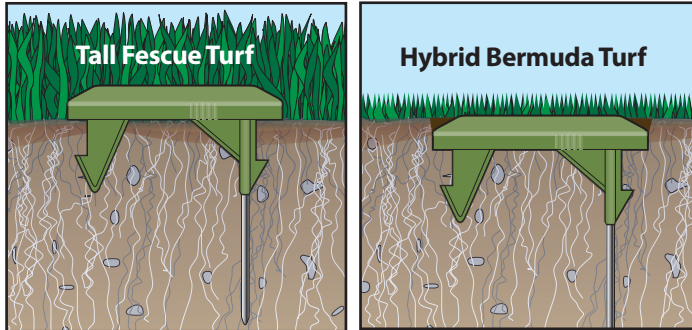

4. Applying even, downward pressure on top of the sensor, insert the sensor probes and retention spikes completely into the soil.

FCC Statement

This equipment has been tested and found to comply with the limits for a Class B digital device, pursuant to Part 15 of the FCC Rules. These limits are designed to provide reasonable protection against harmful interference in a residential installation. This equipment generates, uses and can radiate radio frequency energy and, if not installed and used in accordance with the instructions, may cause harmful interference to radio communications. However, there is no guarantee that interference will not occur in a particular installation. If this equipment generates interference to radio or television reception, which can be determined by turning the equipment on and off, the user is encouraged to try to correct the interference by one or more of the following measures:

1. Reorient or relocate the receiving antenna.
2. Increase the separation between the equipment and receiver.
3. Connect the equipment into an outlet on a circuit different from that to which the receiver is connected.
4. Consult the dealer or an experienced radio/TV technician for help.

The user may find the following booklet prepared by the Federal Communications Commission helpful: "How To Identify and Resolve Radio-TV Interference Problems". This booklet is available from the U.S. Government Printing Office, Washington, DC 20402. Stock No. 004-000-00345-4.

Toro Support

Toro Commitment to Quality

Toro is committed to developing and producing the highest quality, best performing, most dependable products on the market. Because your satisfaction is our first priority, we have provided the Toro Helpline to assist you with any questions or problems that may arise. If for some reason you are not satisfied with your purchase or have questions, please contact us toll free at 1-877-345-8676.

Warranty

The Toro Company and its affiliate, Toro Warranty Company, pursuant to an agreement between them, jointly warrants, to the owner, against defects in material and workmanship for a period of one year from the date of purchase. Neither The Toro Company nor Toro Warranty Company is liable for failure of products not manufactured by them, even though such products may be sold or used in conjunction with Toro products. During such warranty period, we will repair or replace, at our option, any part found to be defective. Return the defective part to the place of purchase. Our liability is limited solely to the replacement or repair of defective parts. There are no other express warranties. This warranty does not apply where equipment is used, or installation is performed, in any manner contrary to Toro's specifications and instructions, nor where equipment is altered or modified. Neither The Toro Company nor Toro Warranty Company is liable for indirect, incidental or consequential damages in connection with the use of equipment, including but not limited to: vegetation loss, the cost of substitute equipment or services required during periods of malfunction or resulting non-use, property damage or personal injury resulting from installer's negligence.

Some states do not allow the exclusion or limitation of incidental or

consequential damages, so the above limitation or exclusion may not apply to you. All implied warranties, including those of merchantability and fitness for use, are limited to the duration of this express warranty. Some states do not allow limitations of how long an implied warranty lasts, so the above limitation may not apply to you. This warranty gives you specific legal rights and you may have other rights which vary from state to state.

Australian Warranty Statement

This product comes with a manufacturer's guarantee against defects in material and workmanship when used for its intended purpose. Our obligation under this guarantee is limited to the repair or replacement of the product at our discretion for the period stated. In the event of a claim, you must immediately cease using the product and return the product, together with your proof of purchase and an explanation of the fault to the store you purchased it from. All costs associated with the return of the product are the purchasers' responsibility. To process the warranty, the retailer must contact Toro Australia via their representative or the phone number listed below.

Our goods come with guarantees that cannot be excluded under the Australian Consumer Law. You are entitled to a replacement or refund for a major failure and for compensation for any other reasonably foreseeable loss or damage. You are also entitled to have the goods repaired or replaced if the goods fail to be of acceptable quality and the failure does not amount to a major failure.

Toro Australia Pty Ltd, 53 Howards Road, Beverley SA 50091300 130 898, info.au@toro.com