

Solar Panel Kit

When designing the **Everfilt Solar Panel Kit**, our goal was a package that provided long-term reliability, all while being exposed to some of the most extreme elements, from below freezing, to temps in excess of 100 degrees fahrenheit. Having a unique, segmented design approach, allows for individual replacement parts as needed.

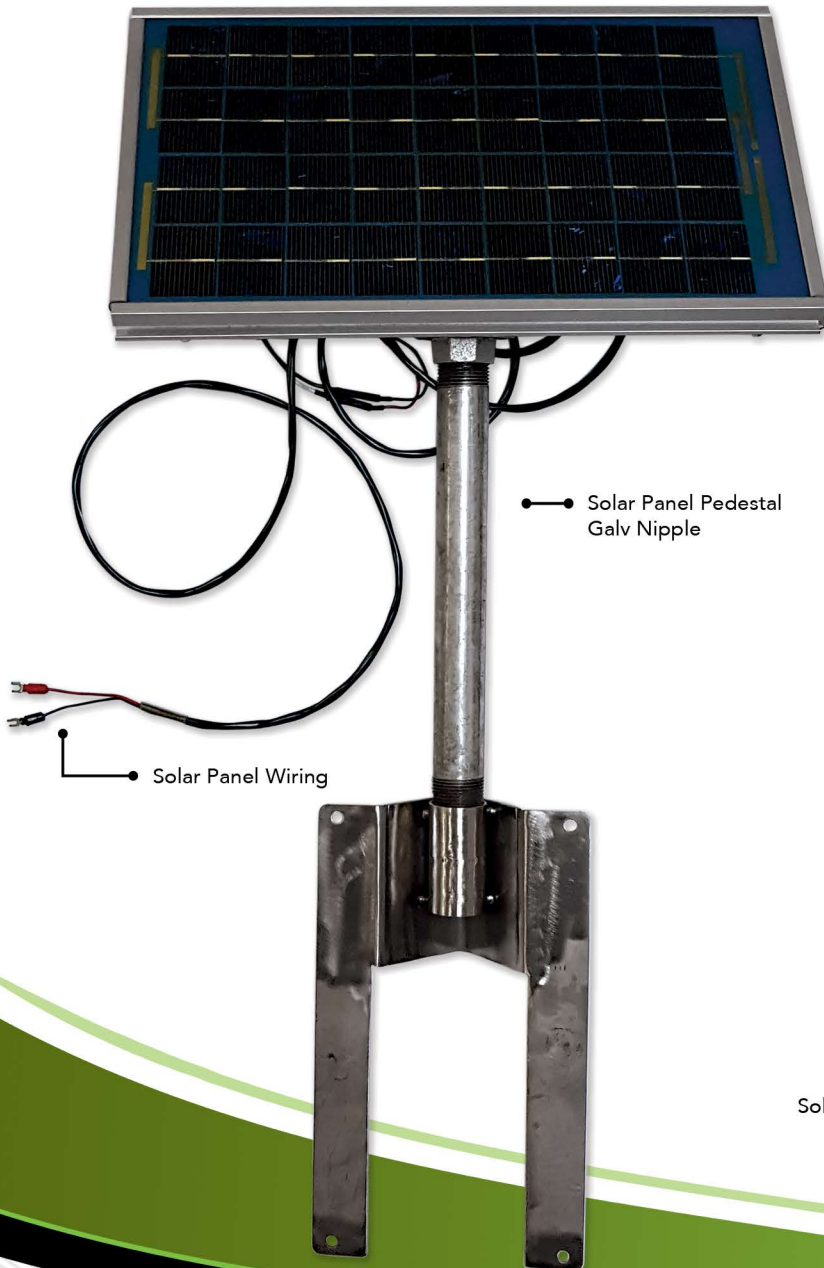

Solar Panel Pieces

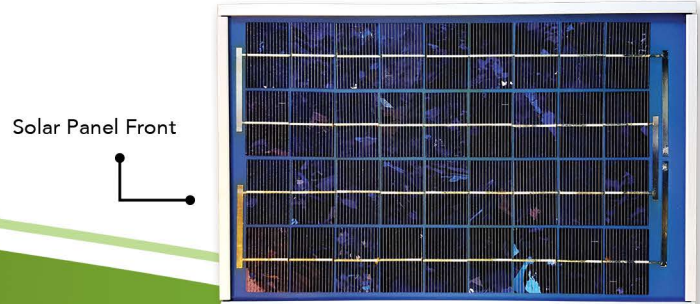
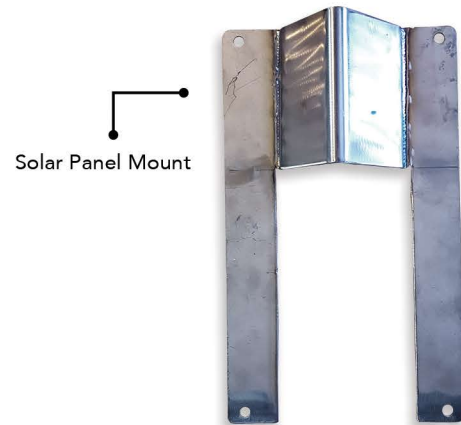

Solar Panel Kit Configuration

Everfilt understands that not all sites have the required power requirements that your filtration system may need to operate correctly and effectively. With these challenges, comes the **Everfilt Solar Panel Kit**, designed with durability in mind, even in the most extreme conditions. This system provides a turnkey solution, regardless of its location.

Solar Panel Mount
1 Ea. Req. — 11.5" (H)

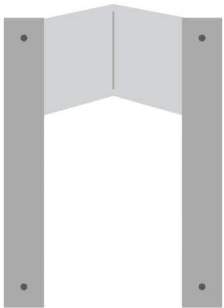

Galv Nipple
1"x12" (H)



Solar Panel Bracket
1 Ea. Req.

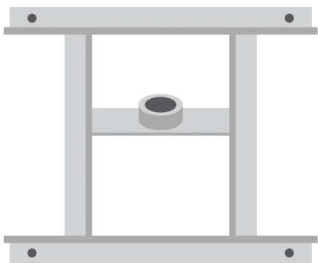

Solar Power Wiring Instructions:

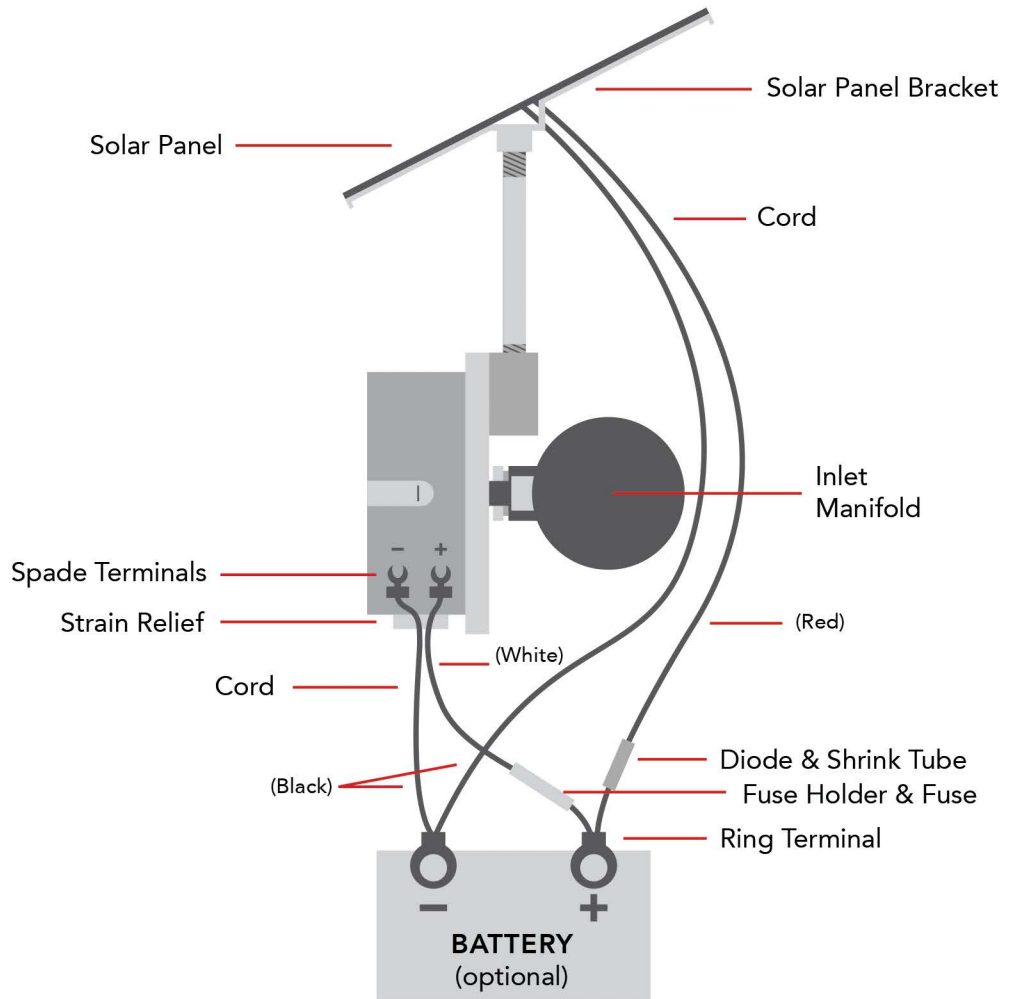
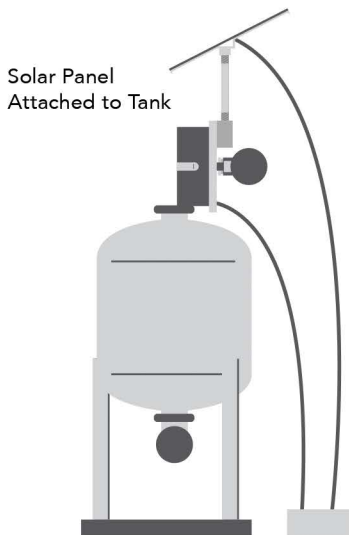

Solar Panel Kit Configuration (continued)

Item	Description	Qty.
A	Solar Panel Assy W/QK Disconnect.	1
B	1/4 - 20x 1 Bolt Set.	4
C	Solar Panel Mt.	1
D	1" Close Nipple, Galv.	1
E	1" Union Galv.	1
F	1"x 12" Nipple, Galv.	1

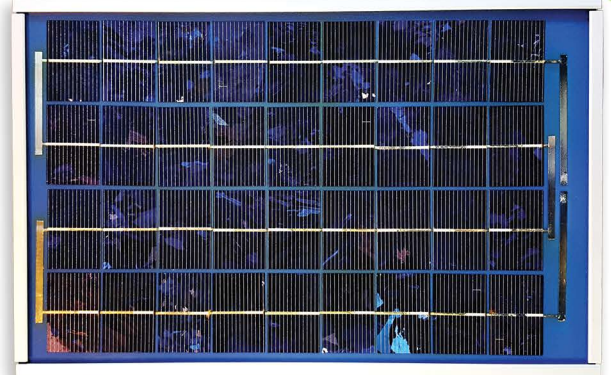

94B Series - Solar Panel

New Style Panel Measures:
16.5" x 9.6"

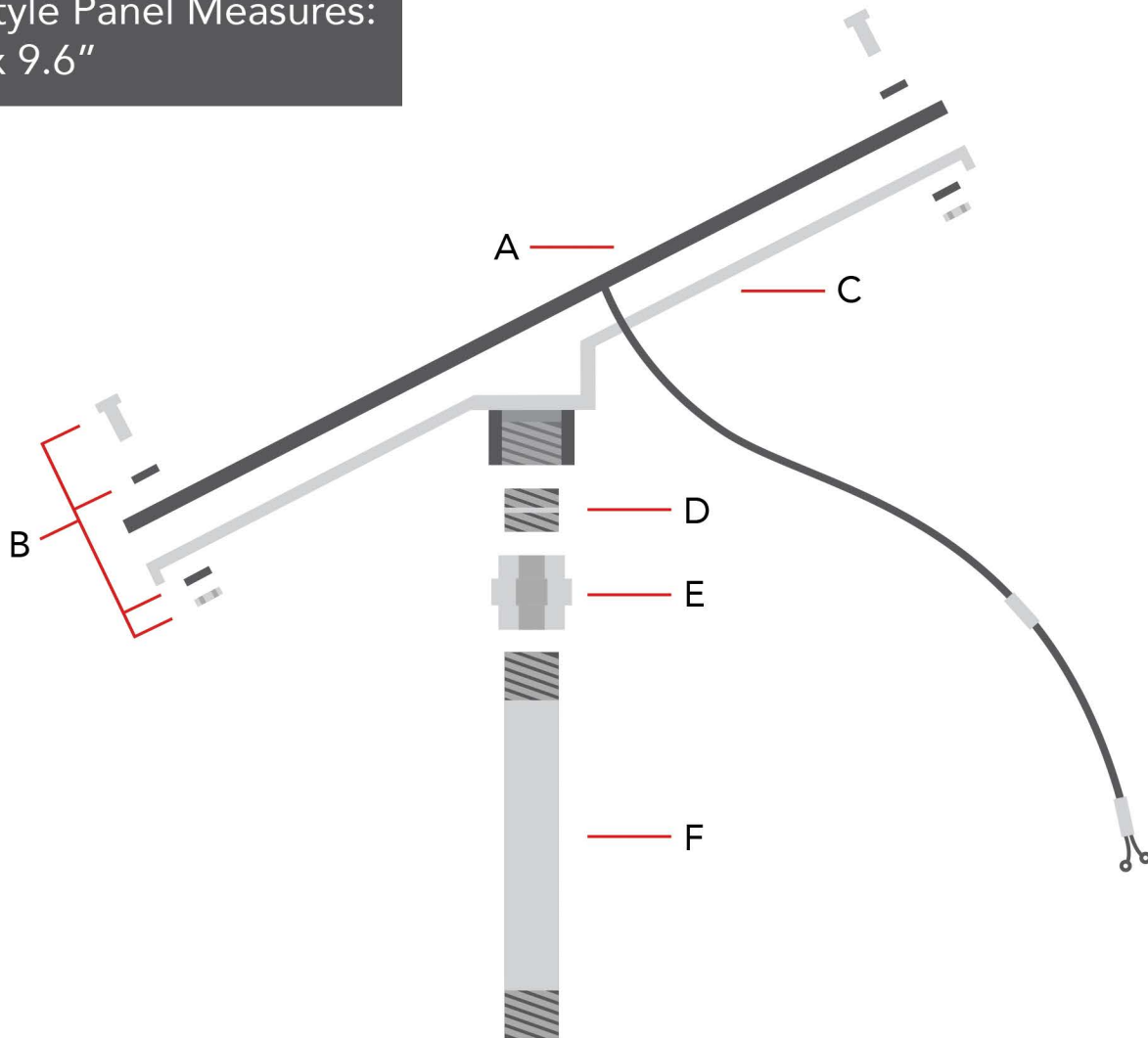

Solar Panel Kit Assembly

Components

1.	Solar Panel W/Bracket.
2.	Solar Panel Lead.
3.	Grommet.
4.	1/4 - 20 x 314 MTB Bolt W/Nut (TYP).
5.	Set Screw.
6.	Enclosure.
7.	Wiring Harness (3ft.).
8.	Solar Panel Pedestal



Solar Battery Kit Assembly:

Side View

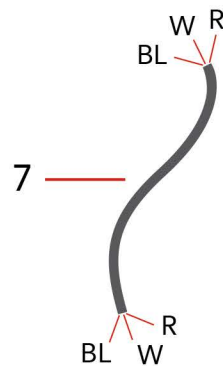
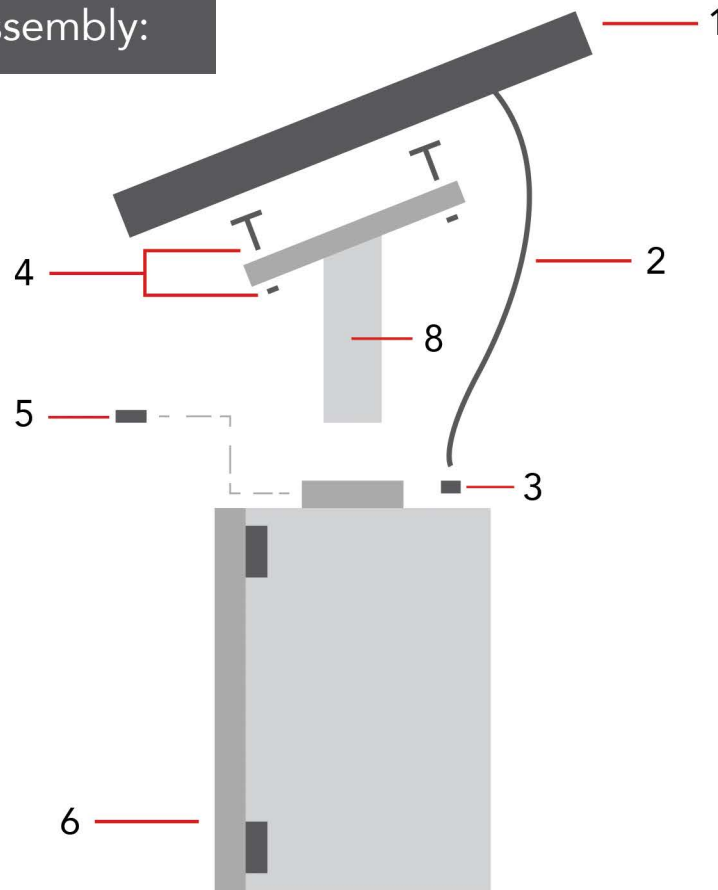

Color Guide

BL = Black

W = White

R = Red