



Programming Guide

VLT[®] AQUA Drive FC 202

Software version: 3.30



Contents

1 Introduction	4
1.1 Purpose of the Manual	4
1.2 Additional Resources	4
1.3 Software Version	4
1.4 Approvals	4
1.5 Symbols	4
1.6 Definitions	4
1.6.1 Frequency Converter	4
1.6.2 Input	4
1.6.3 Motor	4
1.6.4 References	5
1.6.5 Miscellaneous	5
1.7 Abbreviations, Symbols, and Conventions	7
1.8 Safety	8
1.9 Electrical Wiring	10
2 How to Program	13
2.1 The Graphical and Numerical Local Control Panel	13
2.2 How to Program on the Graphical LCP	13
2.2.1 The LCP Display	14
2.2.2 Quick Transfer of Parameter Settings between Multiple Frequency Con- converters	17
2.2.3 Display Mode	18
2.2.4 Display Mode - Selection of Readouts	18
2.2.5 Parameter Set-up	19
2.2.6 Quick Menu Key Functions	19
2.2.7 Quick Menu, Q3 Function Set-ups	19
2.2.8 Quick Menu, Q4 SmartStart	21
2.2.9 Main Menu Mode	21
2.2.10 Parameter Selection	21
2.2.11 Changing Data	21
2.2.12 Changing a Text Value	21
2.2.13 Changing a Data Value	22
2.2.14 Infinitely Variable Change of Numeric Data Value	22
2.2.15 Value, Step by Step	22
2.2.16 Readout and Programming of Indexed Parameters	22
2.2.17 How to Program on the Numerical Local Control Panel	23
2.2.18 LCP Keys	24

3 Parameter Description	26
3.1 Parameter Selection	26
3.2 Parameters 0-** Operation and Display	27
3.3 Parameters 1-** Load and Motor	40
3.4 Parameters 2-** Brakes	64
3.5 Parameters 3-** Reference/Ramps	68
3.6 Parameters 4-** Limits/Warnings	74
3.7 Parameters 5-** Digital In/Out	79
3.8 Parameters 6-** Analog In/Out	94
3.9 Parameters 8-** Communications and Options	104
3.10 Parameters 9-** PROFIBUS	113
3.11 Parameters 10-** CAN Fieldbus	114
3.12 Parameters 13-** Smart Logic	117
3.13 Parameters 14-** Special Functions	137
3.14 Parameters 15-** Drive Information	147
3.15 Parameters 16-** Data Readouts	156
3.16 Parameters 18-** Data Readouts 2	163
3.17 Parameters 20-** FC Closed Loop	166
3.18 Parameters 21-** Extended Closed Loop	178
3.19 Parameters 22-** Application Functions	186
3.20 Parameters 23-** Time-based Functions	200
3.21 Parameters 24-** Application Functions 2	211
3.22 Parameters 25-** Cascade Controller	216
3.23 Parameters 26-** Analog I/O Option MCB 109	229
3.24 Parameters 27-** Cascade CTL Option	236
3.25 Parameters 29-** Water Application Functions	249
3.26 Parameters 30-** Special Features	257
3.27 Parameters 31-** Bypass Option	258
3.28 Parameters 35-** Sensor Input Option	259
4 Parameter Lists	262
4.1 Parameter Options	262
4.1.1 Default Settings	262
4.1.2 0-** Operation/Display	263
4.1.3 1-** Load and Motor	265
4.1.4 2-** Brakes	267
4.1.5 3-** Reference/Ramps	268
4.1.6 4-** Limits/Warnings	269

4.1.7 5-** Digital In/Out	270
4.1.8 6-** Analog In/Out	272
4.1.9 8-** Comm. and Options	274
4.1.10 9-** PROFIdrive	275
4.1.11 10-** CAN Fieldbus	277
4.1.12 13-** Smart Logic	278
4.1.13 14-** Special Functions	279
4.1.14 15-** Drive Information	281
4.1.15 16-** Data Readouts	283
4.1.16 18-** Info & Readouts	285
4.1.17 20-** Drive Closed Loop	286
4.1.18 21-** Ext. Closed Loop	287
4.1.19 22-** Appl. Functions	289
4.1.20 23-** Time-based Functions	291
4.1.21 24-** Appl. Functions 2	292
4.1.22 25-** Cascade Controller	292
4.1.23 26-** Analog I/O Option	293
4.1.24 29-** Water Application Functions	295
4.1.25 30-** Special Features	297
4.1.26 31-** Bypass Option	297
4.1.27 35-** Sensor Input Option	297
5 Troubleshooting	299
5.1 Status Messages	299
5.1.1 Warnings/Alarm Messages	299
Index	306

1 Introduction

1.1 Purpose of the Manual

The programming guide provides information required for programming the frequency converter in a diversity of applications.

VLT® is a registered trademark.

1.2 Additional Resources

Other resources are available to understand advanced frequency converter functions and programming.

- The *VLT® AQUA Drive FC 202 Operating Instructions* describe mechanical and electrical installation of the frequency converter.
- The *VLT® AQUA Drive FC 202 Design Guide* provides detailed information about capabilities and functionality to design motor control systems.
- Instructions for operation with optional equipment.

Supplementary publications and manuals are available from Danfoss. See drives.danfoss.com/knowledge-center/technical-documentation/ for listings.

1.3 Software Version

<p>Software version: 3.30</p>
<p>The software version number can be read from parameter 15-43 <i>Software Version</i>.</p>

1.4 Approvals



1.5 Symbols

The following symbols are used in this guide:



Indicates a potentially hazardous situation that could result in death or serious injury.



Indicates a potentially hazardous situation that could result in minor or moderate injury. It can also be used to alert against unsafe practices.



Indicates important information, including situations that can result in damage to equipment or property.

1.6 Definitions

1.6.1 Frequency Converter

- $I_{VLT,MAX}$
Maximum output current.
- $I_{VLT,N}$
Rated output current supplied by the frequency converter.
- $U_{VLT,MAX}$
Maximum output voltage.

1.6.2 Input

Control command

Start and stop the connected motor with LCP and digital inputs.

Functions are divided into 2 groups.

Functions in group 1 have higher priority than functions in group 2.

Group 1	Reset, coast stop, reset and coast stop, quick stop, DC brake, stop, the [OFF] key.
Group 2	Start, pulse start, reversing, start reversing, jog, freeze output.

Table 1.1 Function Groups

1.6.3 Motor

Motor running

Torque generated on output shaft and speed from 0 RPM to maximum speed on motor.

f_{JOG}
Motor frequency when the jog function is activated (via digital terminals).

f_M
Motor frequency.

f_{MAX}
Maximum motor frequency.

f_{MIN}

Minimum motor frequency.

 $f_{M,N}$

Rated motor frequency (nameplate data).

 I_M

Motor current (actual).

 $I_{M,N}$

Rated motor current (nameplate data).

 $n_{M,N}$

Nominal motor speed (nameplate data).

 n_s

Synchronous motor speed.

$$n_s = \frac{2 \times \text{par. 1} - 23 \times 60 \text{ s}}{\text{par. 1} - 39}$$

 n_{slip}

Motor slip.

 $P_{M,N}$

Rated motor power (nameplate data in kW or hp).

 $T_{M,N}$

Rated torque (motor).

 U_M

Instant motor voltage.

 $U_{M,N}$

Rated motor voltage (nameplate data).

Break-away torque

Figure 1.1 Break-away Torque

 η_{VLT}

The efficiency of the frequency converter is defined as the ratio between the power output and the power input.

Start-disable command

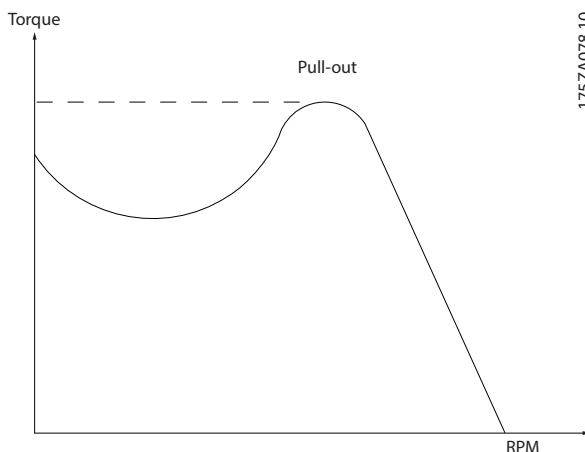
A stop command belonging to Group 1 control commands - see Table 1.1.

Stop command

A stop command belonging to Group 1 control commands - see Table 1.1.

1.6.4 References**Analog reference**

A signal transmitted to the analog inputs 53 or 54 (voltage or current).

Binary reference

A signal transmitted to the serial communication port.

Preset reference

A defined preset reference to be set from -100% to +100% of the reference range. Selection of 8 preset references via the digital terminals.

Pulse reference

A pulse frequency signal transmitted to the digital inputs (terminal 29 or 33).

Ref_{MAX}

Determines the relationship between the reference input at 100% full scale value (typically 10 V, 20 mA) and the resulting reference. The maximum reference value is set in parameter 3-03 Maximum Reference.

Ref_{MIN}

Determines the relationship between the reference input at 0% value (typically 0 V, 0 mA, 4 mA) and the resulting reference. The minimum reference value is set in parameter 3-02 Minimum Reference.

1.6.5 Miscellaneous**Analog inputs**

The analog inputs are used for controlling various functions of the frequency converter.

There are 2 types of analog inputs:

Current input, 0–20 mA, and 4–20 mA

Voltage input, -10 V DC to +10 V DC.

Analog outputs

The analog outputs can supply a signal of 0–20 mA, 4–20 mA.

Automatic motor adaptation, AMA

The AMA algorithm determines the electrical parameters for the connected motor at standstill.

Brake resistor

The brake resistor is a module capable of absorbing the brake power generated in regenerative braking. This regenerative brake power increases the DC-link voltage and a brake chopper ensures that the power is transmitted to the brake resistor.

CT characteristics

Constant torque characteristics used for all applications such as conveyor belts, displacement pumps, and cranes.

Digital inputs

The digital inputs can be used for controlling various functions of the frequency converter.

Digital outputs

The frequency converter features 2 solid-state outputs that can supply a 24 V DC (maximum 40 mA) signal.

DSP

Digital signal processor.

ETR

Electronic thermal relay is a thermal load calculation based on present load and time. Its purpose is to estimate the motor temperature.

HIPERFACE®

HIPERFACE® is a registered trademark by Stegmann.

Initializing

If initializing is carried out (*parameter 14-22 Operation Mode*), the frequency converter returns to the default setting.

Intermittent duty cycle

An intermittent duty rating refers to a sequence of duty cycles. Each cycle consists of an on-load and an off-load period. The operation can be either periodic duty or non-periodic duty.

LCP

The local control panel makes up a complete interface for control and programming of the frequency converter. The control panel is detachable and can be installed up to 3 m (10 ft) from the frequency converter, that is, in a front panel with the installation kit option.

NLCP

Numerical local control panel interface for control and programming of the frequency converter. The display is numerical and the panel is used to show process values. The NLCP has no storage and copy functions.

lsb

Least significant bit.

msb

Most significant bit.

MCM

Short for mille circular mil, an American measuring unit for cable cross-section. 1 MCM=0.5067 mm².

Online/offline parameters

Changes to online parameters are activated immediately after the data value is changed. Press [OK] to activate changes to off-line parameters.

Process PID

The PID control maintains the required speed, pressure, temperature, and so on, by adjusting the output frequency to match the varying load.

PCD

Process control data.

Power cycle

Switch off the mains until the display (LCP) is dark, then turn power on again.

Pulse input/incremental encoder

An external, digital pulse transmitter used for feeding back information on motor speed. The encoder is used in applications where great accuracy in speed control is required.

RCD

Residual current device.

Set-up

Save parameter settings in 4 set-ups. Change between the 4 parameter set-ups and edit 1 set-up, while another set-up is active.

SFAVM

Switching pattern called stator flux-oriented asynchronous vector modulation (*parameter 14-00 Switching Pattern*).

Slip compensation

The frequency converter compensates for the motor slip by giving the frequency a supplement that follows the measured motor load keeping the motor speed almost constant.

SLC

The SLC (smart logic control) is a sequence of user-defined actions executed when the associated user-defined events are evaluated as true by the SLC. (See *chapter 3.12 Parameters 13-** Smart Logic*).

STW

Status word.

FC standard bus

Includes RS485 bus with FC protocol or MC protocol. See *parameter 8-30 Protocol*.

THD

Total harmonic distortion states the total contribution of harmonics.

Thermistor

A temperature-dependent resistor placed on the frequency converter or the motor.

Trip

A state entered in fault situations, for example if the frequency converter is subject to an overtemperature or when the frequency converter is protecting the motor, process, or mechanism. The frequency converter prevents a restart until the cause of the fault has disappeared. To cancel the trip state, restart the frequency converter. Do not use the trip state for personal safety.

Trip lock

The frequency converter enters this state in fault situations to protect itself. The frequency converter requires physical intervention, for example when there is a short circuit on the output. A trip lock can only be canceled by disconnecting mains, removing the cause of the fault, and reconnecting the frequency converter. Restart is prevented until the trip state is canceled by activating reset or, sometimes, by being programmed to reset automatically. Do not use the trip lock state for personal safety.

VT characteristics

Variable torque characteristics used for pumps and fans.

VVC⁺

If compared with standard voltage/frequency ratio control, voltage vector control (VVC⁺) improves the dynamics and the stability, both when the speed reference is changed and in relation to the load torque.

60° AVM

60° asynchronous vector modulation
(parameter 14-00 Switching Pattern).

Power factor

The power factor is the relation between I_1 and I_{RMS} .

$$\text{Power factor} = \frac{\sqrt{3} \times U \times I_1 \cos\phi}{\sqrt{3} \times U \times I_{RMS}}$$

The power factor for 3-phase control:

$$\text{Power factor} = \frac{I_1 \times \cos\phi_1}{I_{RMS}} = \frac{I_1}{I_{RMS}} \text{ since } \cos\phi_1 = 1$$

The power factor indicates to which extent the frequency converter imposes a load on the mains supply.

The lower the power factor, the higher the I_{RMS} for the same kW performance.

$$I_{RMS} = \sqrt{I_1^2 + I_5^2 + I_7^2 + \dots + I_n^2}$$

In addition, a high power factor indicates that the different harmonic currents are low.

The DC coils in the frequency converters produce a high power factor, which minimizes the imposed load on the mains supply.

Target position

The final target position specified by positioning commands. The profile generator uses this position to calculate the speed profile.

Commanded position

The actual position reference calculated by the profile generator. The frequency converter uses the commanded position as setpoint for position PI.

Actual position

The actual position from an encoder, or a value that the motor control calculates in open loop. The frequency converter uses the actual position as feedback for position PI.

Position error

Position error is the difference between the actual position and the commanded position. The position error is the input for the position PI controller.

Position unit

The physical unit for position values.

1.7 Abbreviations, Symbols, and Conventions

°C	Degrees Celsius
°F	Degrees Fahrenheit
AC	Alternating current
AEO	Automatic energy optimization
AWG	American wire gauge
AMA	Automatic motor adaptation
DC	Direct current
EMC	Electro magnetic compatibility
ETR	Electronic thermal relay
$f_{M,N}$	Nominal motor frequency
FC	Frequency converter
I_{INV}	Rated inverter output current
I_{LIM}	Current limit
$I_{M,N}$	Nominal motor current
$I_{VLT,MAX}$	Maximum output current
$I_{VLT,N}$	Rated output current supplied by the frequency converter
IP	Ingress protection
LCP	Local control panel
MCT	Motion control tool
n_s	Synchronous motor speed
$P_{M,N}$	Nominal motor power
PELV	Protective extra low voltage
PCB	Printed circuit board
PM Motor	Permanent magnet motor
PWM	Pulse width modulation
RPM	Revolutions per minute
Regen	Regenerative terminals
T_{LIM}	Torque limit
$U_{M,N}$	Nominal motor voltage

1.8 Safety

⚠WARNING

HIGH VOLTAGE

Frequency converters contain high voltage when connected to AC mains input, DC supply, or load sharing. Failure to perform installation, start-up, and maintenance by qualified personnel can result in death or serious injury.

- Only qualified personnel must perform installation, start-up, and maintenance.
- Before performing any service or repair work, use an appropriate voltage measuring device to make sure that there is no remaining voltage on the frequency converter.

Safety regulations

- Disconnect the mains supply to the frequency converter whenever repair work is to be carried out. Check that the mains supply has been disconnected and that the necessary time has elapsed before removing motor and mains supply plugs. For information about the discharge time, see *Table 1.2*.
- [Off] does not disconnect the mains supply and therefore, it must not be used as a safety switch.
- Ground the equipment properly. Protect the user against supply voltage and protect the motor against overload in accordance with applicable national and local regulations.
- The ground leakage current exceeds 3.5 mA.
- Protection against motor overload is not included in the factory setting. If this function is required, set *parameter 1-90 Motor Thermal Protection* to data value [4] *ETR trip 1* or data value [3] *ETR warning 1*.
- Do not remove the plugs for the motor and mains supply while the frequency converter is connected to mains. Check that the mains supply has been disconnected and that the necessary time has elapsed before removing motor and mains plugs.
- The frequency converter has more voltage sources than L1, L2, and L3, when load sharing (linking of DC-link) or external 24 V DC is installed. Check that all voltage sources have been disconnected and that the necessary time has elapsed before commencing repair work. For information about the discharge time, see *Table 1.2*.

⚠WARNING

UNINTENDED START

When the frequency converter is connected to AC mains, DC supply, or load sharing, the motor may start at any time. Unintended start during programming, service, or repair work can result in death, serious injury, or property damage. The motor can start via an external switch, a fieldbus command, an input reference signal from the LCP, or after a cleared fault condition.

To prevent unintended motor start:

- Disconnect the frequency converter from the mains.
- Press [Off/Reset] on the LCP before programming parameters.
- Completely wire and assemble the frequency converter, motor, and any driven equipment before connecting the frequency converter to AC mains, DC supply, or load sharing.

⚠WARNING

DISCHARGE TIME

The frequency converter contains DC-link capacitors, which can remain charged even when the frequency converter is not powered. High voltage can be present even when the warning LED indicator lights are off. Failure to wait the specified time after power has been removed before performing service or repair work can result in death or serious injury.

- Stop the motor.
- Disconnect AC mains and remote DC-link power supplies, including battery back-ups, UPS, and DC-link connections to other frequency converters.
- Disconnect or lock PM motor.
- Wait for the capacitors to discharge fully. The minimum waiting time is specified in *Table 1.2* and is also visible on the nameplate on top of the frequency converter.
- Before performing any service or repair work, use an appropriate voltage measuring device to make sure that the capacitors are fully discharged.

Voltage [V]	Minimum waiting time (minutes)		
	4	7	15
200–240	0.25–3.7 kW (0.34–5 hp)	–	5.5–45 kW (7.5–60 hp)
380–480	0.37–7.5 kW (0.5–10 hp)	–	11–90 kW (15–121 hp)
525–600	0.75–7.5 kW (1–10 hp)	–	11–90 kW (15–121 hp)
525–690	–	1.1–7.5 kW (1.5–10 hp)	11–90 kW (15–121 hp)

Table 1.2 Discharge Time

NOTICE!

When using Safe Torque Off, always follow the instructions in the *VLT® Frequency Converters - Safe Torque Off Operating Instructions*.

NOTICE!

Control signals from or within the frequency converter may in rare cases be activated in error, be delayed, or fail to occur entirely. When used in situations where safety is critical, these control signals must not be relied on exclusively.

NOTICE!

Hazardous situations must be identified by the machine builder/integrator who is responsible for taking necessary preventive means into consideration. More monitoring and protective devices may be included, always according to valid national safety regulations, for example, law on mechanical tools, regulations for the prevention of accidents.

Protection mode

Once a hardware limit on motor current or DC-link voltage is exceeded, the frequency converter enters the protection mode. Protection mode means a change of the PWM modulation strategy and a low switching frequency to minimize losses. This continues for 10 s after the last fault and increases the reliability and the robustness of the frequency converter while re-establishing full control of the motor.

1.9 Electrical Wiring

1.9.1 Electrical Wiring - Control Cables

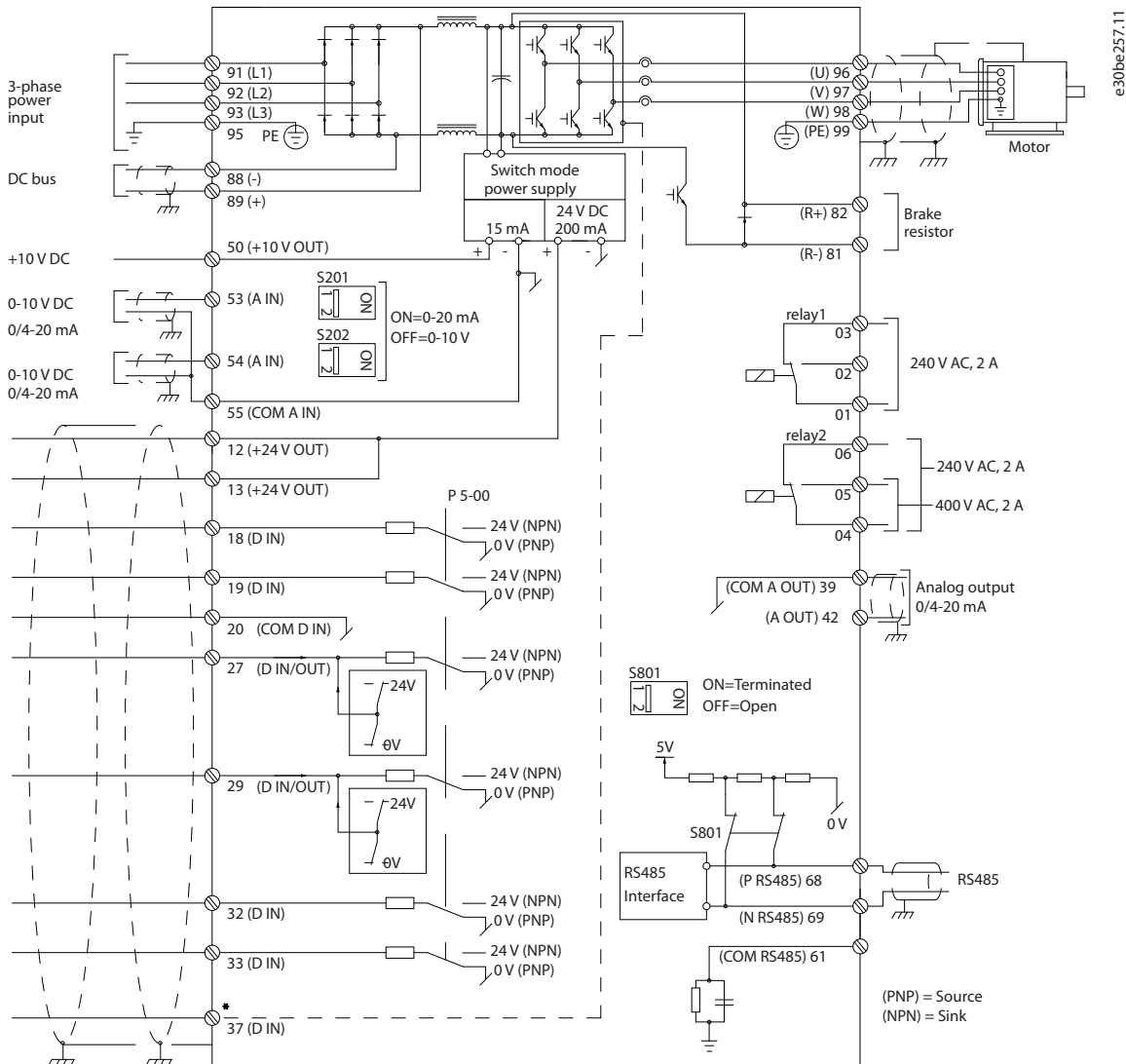

Figure 1.2 Basic Wiring Schematic Drawing

A = Analog, D = Digital

Terminal 37 is used for Safe Torque Off. For Safe Torque Off installation instructions, refer to the *VLT® Frequency Converters - Safe Torque Off Operating Instructions*.

* Terminal 37 is not included in FC 202 (except enclosure size A1). Relay 2 and terminal 29 have no function in VLT® AQUA Drive FC 202.

Long control cables and analog signals may in rare cases, and depending on installation, result in 50/60 Hz ground loops due to noise from mains supply cables.

If this occurs, it may be necessary to break the shield or insert a 100 nF capacitor between shield and enclosure.

Connect the digital and analog inputs and outputs separately to the common inputs (terminals 20, 55, and 39) of the frequency converter to avoid ground currents from both groups to affect other groups. For example, switching on the digital input may disturb the analog input signal.

Input polarity of control terminals

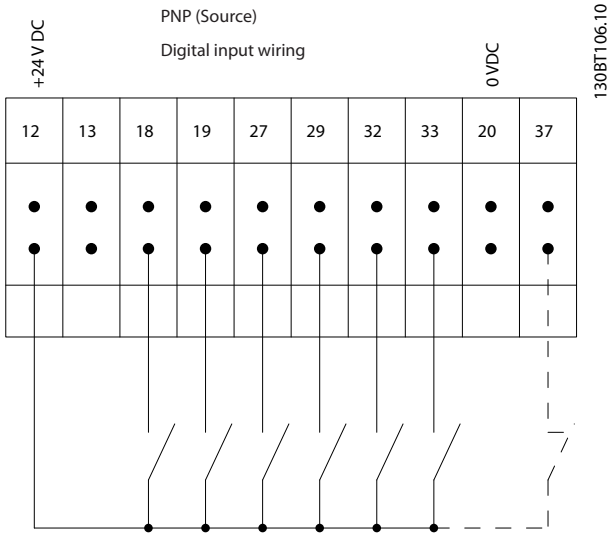

Figure 1.3 PNP (Source)

130BT106.10

130BA681.10

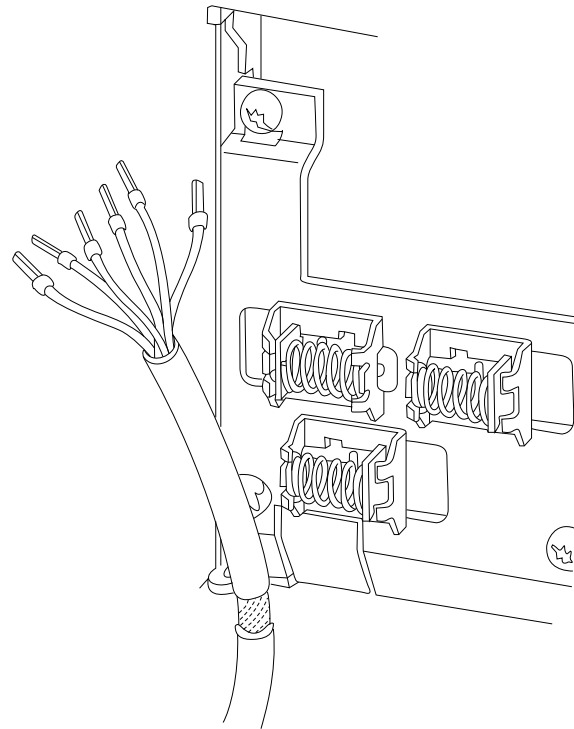

Figure 1.5 Grounding of Shielded/Armored Control Cables

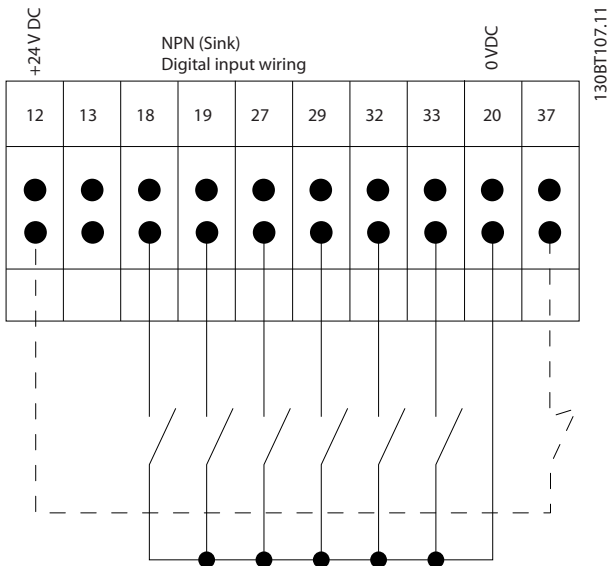

Figure 1.4 NPN (Sink)

130BT107.11

NOTICE!

Control cables must be shielded/armored.

See the section *Grounding of Shielded Control Cables* in the *design guide* for the correct termination of control cables.

1.9.2 Start/Stop

Terminal 18 = Parameter 5-10 Terminal 18 Digital Input [8] Start.

Terminal 27 = Parameter 5-12 Terminal 27 Digital Input [0] No operation (default [2] Coast inverse).

Terminal 37 = Safe Torque Off (where available).

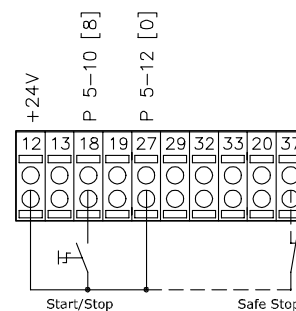

130BA155.12

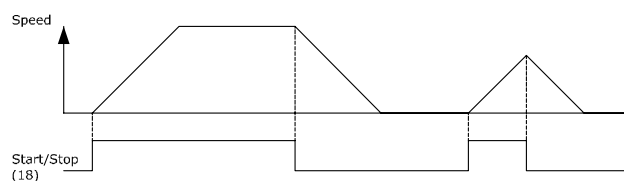

Figure 1.6 Start/Stop

1.9.3 Pulse Start/Stop

Terminal 18 = Parameter 5-10 Terminal 18 Digital Input [9] Latched start.

Terminal 27 = Parameter 5-12 Terminal 27 Digital Input [6] Stop inverse.

Terminal 37 = Safe Torque Off (where available).

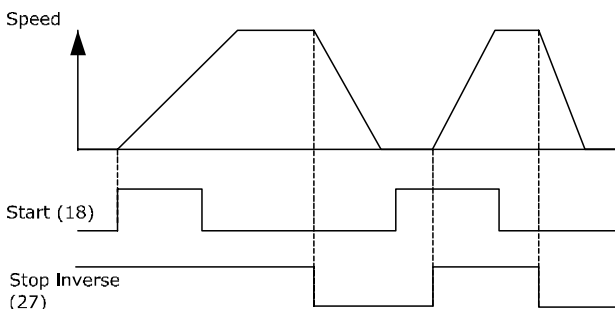
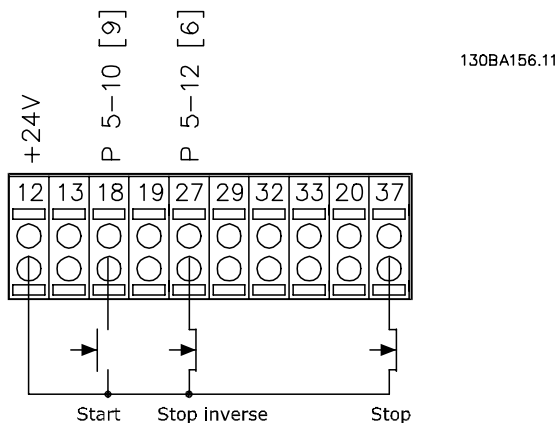

Figure 1.7 Pulse Start/Stop

1.9.4 Speed Up/Down

Terminals 29/32 = Speed up/down

Terminal 18 = Parameter 5-10 Terminal 18 Digital Input [9] Start (default).

Terminal 27 = Parameter 5-12 Terminal 27 Digital Input [19] Freeze reference.

Terminal 29 = Parameter 5-13 Terminal 29 Digital Input [21] Speed up.

Terminal 32 = Parameter 5-14 Terminal 32 Digital Input [22] Speed down.

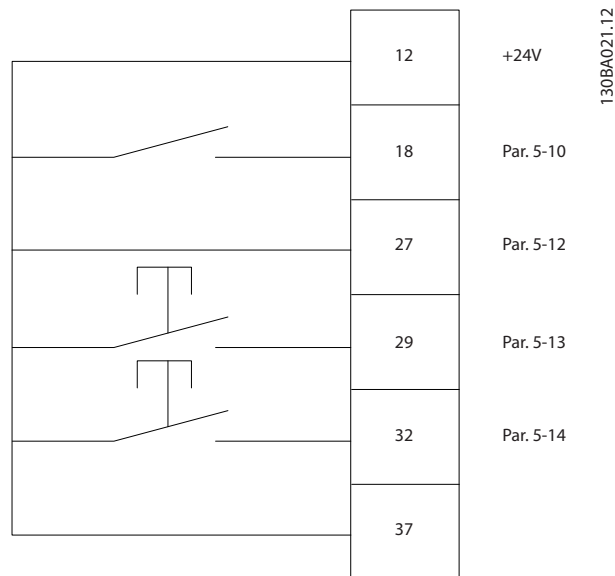

Figure 1.8 Speed Up/Down

1.9.5 Potentiometer Reference

Voltage reference via a potentiometer

Reference source 1 = [1] Analog input 53 (default).

Terminal 53, Low Voltage = 0 V.

Terminal 53, High Voltage = 10 V.

Terminal 53, Low Ref./Feedback = 0 RPM.

Terminal 53, High Ref./Feedback = 1500 RPM.

Switch S201 = OFF (U).

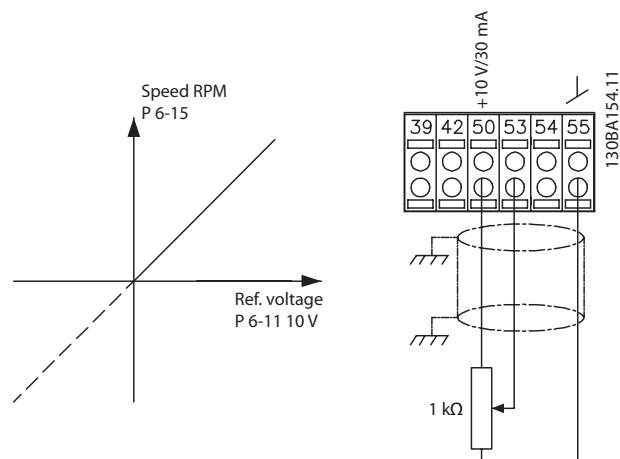

Figure 1.9 Potentiometer Reference

2 How to Program

2.1 The Graphical and Numerical Local Control Panel

Easy programming of the frequency converter is done via the graphical LCP (LCP 102). For information about using the numerical local control panel (LCP 101), see *chapter 2.2.17 How to Program on the Numerical Local Control Panel*.

2.2 How to Program on the Graphical LCP

The LCP is divided into 4 functional groups:

1. Graphical display with status lines.
2. Menu keys and indicator lights - changing parameters and switching between display functions.
3. Navigation keys and indicator lights.
4. Operation keys and indicator lights.

The LCP display can show up to 5 items of operating data while showing *Status*.

Display lines:

- a. **Status line:** Status messages showing icons and graphics.
- b. **Line 1–2:** Operator data lines showing data defined or selected. Add up to 1 extra line by pressing [Status].
- c. **Status line:** Status messages showing text.

NOTICE!

If start-up is delayed, the LCP shows the **INITIALIZING** message until it is ready. Adding or removing options can delay the start-up.

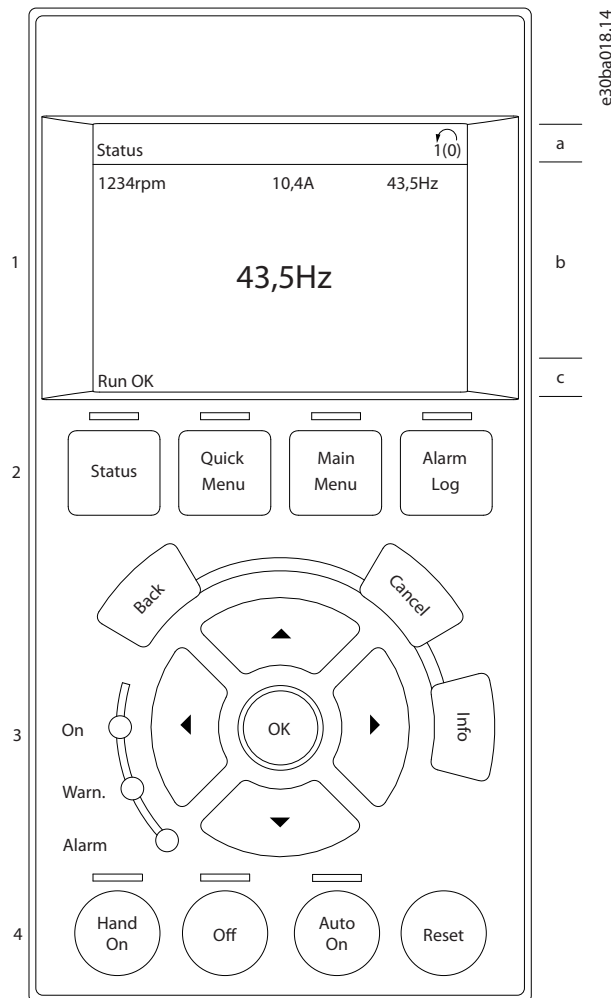

Figure 2.1 LCP

2.2.1 The LCP Display

The LCP display has backlight and a total of 6 alphanumeric lines. The display lines show the direction of rotation (arrow), the selected set-up, and the programming set-up. The display is divided into 3 sections.

Top section

Shows up to 2 measurements in normal operating status.

Middle section

The top line shows up to 5 measurements with related units, regardless of status (except if there is an alarm/warning).

Bottom section

Always shows the state of the frequency converter in *Status mode*.

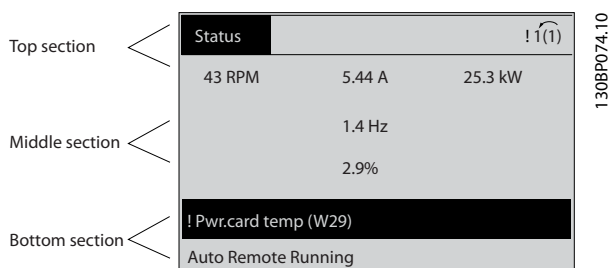

Figure 2.2 Bottom Section

The active set-up (selected as the active set-up in *parameter 0-10 Active Set-up*) is shown. When programming another set-up than the active set-up, the number of the programmed set-up appears to the right.

Display contrast adjustment

Press [Status] and [▲] for darker display.
Press [Status] and [▼] for brighter display.

Most parameter set-ups can be changed immediately via the LCP, unless a password has been created via *parameter 0-60 Main Menu Password* or via *parameter 0-65 Quick Menu Password*.

Indicator lights

If certain threshold values are exceeded, the alarm and/or warning indicator lights up. A status and an alarm text appear on the LCP.

The ON indicator light is activated when the frequency converter receives mains voltage, or via a DC bus terminal, or a 24 V external supply. At the same time, the backlight is on.

- Green LED/On: Control section is working.
- Yellow LED/Warn.: Indicates a warning.
- Flashing red LED/Alarm: Indicates an alarm.

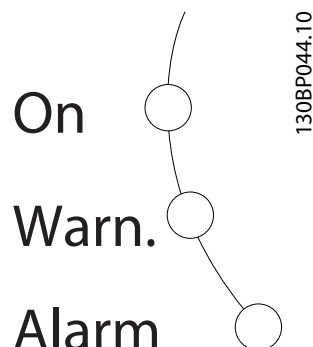

Figure 2.3 Indicator Lights

LCP keys

The control keys are divided into functions. The keys below the display and indicator lights are used for parameter set-up, including the option of display indication during normal operation.



Figure 2.4 LCP Keys

[Status]

Indicates the status of the frequency converter and/or the motor. Select between 3 different readouts by pressing [Status]: 5-line readouts, 4-line readouts, or smart logic control.

Press [Status] to select the mode of display or to return to display mode from either the *Quick Menu* mode, the *Main Menu* mode, or *Alarm* mode. Also use [Status] to toggle single or double readout mode.

[Quick Menu]

Provides quick access to the most common functions of the frequency converter.

The [Quick Menu] consists of:

- Q1: My personal menu.
- Q2: Quick set-up.
- Q3: Function set-ups.
- Q4: SmartStart.
- Q5: Changes made.
- Q6: Loggings.
- Q7: Water and pumps.

The function set-up provides quick access to all parameters required for most water and wastewater applications including:

- Variable torque.
- Constant torque.
- Pumps.
- Dosing pumps.
- Well pumps.
- Booster pumps.
- Mixer pumps.
- Aeration blowers.
- Other pump.
- Fan applications.

Among other features, it also includes parameters for selecting the following:

- Which variables to show on the LCP.
- Digital preset speeds.
- Scaling of analog references.
- Closed-loop single-zone and multi-zone applications.
- Specific functions related to water.
- Wastewater applications.

The quick menu *Q7: Water and Pumps* provides direct access to some of the most important dedicated water and pump features:

- Q7-1: Special ramps (initial ramp, final ramp, check valve ramp).
- Q7-2: Sleep mode.
- Q7-3: Deragging.
- Q7-4: Dry Run.
- Q7-5: End of Curve Detection.
- Q7-6: Flow Compensation.
- Q7-7: Pipe Fill (Horizontal Pipes, Vertical Pipes, Mixed Systems).
- Q7-8: Control Performance.
- Q7-9: Min. Speed Monitor.

The *Quick Menu* parameters can be accessed immediately, unless a password was created via 1 of the following parameters:

- *Parameter 0-60 Main Menu Password.*
- *Parameter 0-61 Access to Main Menu w/o Password.*
- *Parameter 0-65 Personal Menu Password.*
- *Parameter 0-66 Access to Personal Menu w/o Password.*

It is possible to switch directly between *Quick Menu* mode and *Main Menu* mode.

[Main Menu]

This section is used for programming all parameters. The *Main Menu* parameters can be accessed immediately unless a password has been created via 1 of the following parameters:

- *Parameter 0-60 Main Menu Password.*
- *Parameter 0-61 Access to Main Menu w/o Password.*
- *Parameter 0-65 Personal Menu Password.*
- *Parameter 0-66 Access to Personal Menu w/o Password.*

For most water and wastewater applications, it is not necessary to access the *Main Menu* parameters. The *Quick Menu*, quick set-up, and function set-ups provide the simplest and quickest access to the typical required parameters.

It is possible to switch directly between *Main Menu* mode and *Quick Menu* mode.

To create a parameter shortcut, press [Main Menu] for 3 s. The parameter shortcut allows direct access to any parameter.

[Alarm Log]

Shows an alarm list of the 5 latest alarms (numbered A1–A5). To obtain more details about an alarm, press the navigation keys to navigate to the alarm number and press [OK]. Just before entering the alarm mode, information about the condition of the frequency converter is provided.

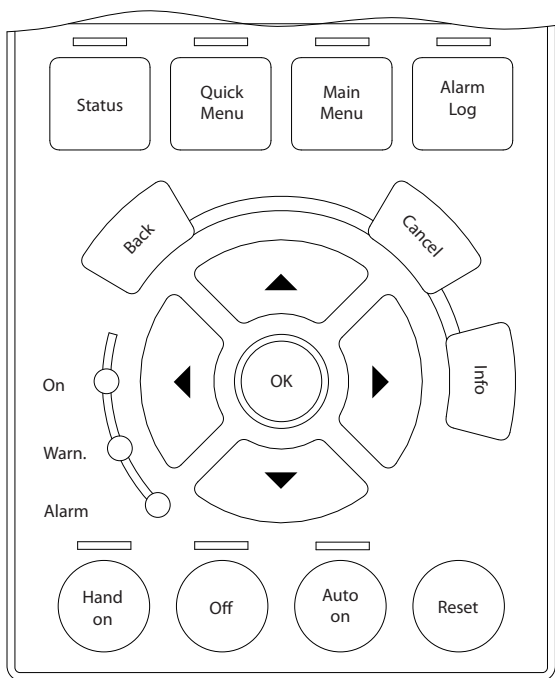

Figure 2.5 LCP

[Back]

Reverts to the previous step or layer in the navigation structure.

[Cancel]

Last change or command is canceled as long as the display has not been changed.

[Info]

Supplies information about a command, parameter, or function in any display window. [Info] provides detailed information whenever help is needed.

Exit *info* mode by pressing either [Info], [Back], or [Cancel].



Figure 2.6 Back



Figure 2.7 Cancel



Figure 2.8 Info

Navigation keys

The 4 navigation keys are used to navigate between the different options available in *Quick Menu*, *Main Menu*, and *Alarm Log*. Press the keys to move the cursor.

[OK]

Is used to select a parameter marked by the cursor and to enable the change of a parameter.

Local control keys

Local control keys are at the bottom of the LCP.

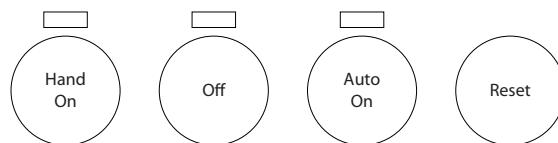

Figure 2.9 Local Control Keys

[Hand On]

Enables control of the frequency converter via the LCP. [Hand On] also starts the motor, and it is now possible to enter the motor speed data with the navigation keys. The key can be selected as [1] *Enable* or [0] *Disable* via *parameter 0-40 [Hand on] Key on LCP*. External stop signals activated with control signals, or a fieldbus, override a start command via the LCP.

The following control signals are still active when [Hand On] is activated:

- [Hand On] - [Off] - [Auto On].
- Reset.
- Coast stop inverse.
- Reversing.
- Set-up select bit 0 - Set-up select bit 1.
- Stop command from serial communication.
- Quick stop.
- DC brake.

[Off]

Stops the connected motor. The key can be selected as [1] Enable or [0] Disable via parameter 0-41 [Off] Key on LCP. If no external stop function is selected and the [Off] key is inactive, stop the motor by disconnecting the voltage.

[Auto On]

Enables control of the frequency converter via the control terminals and/or serial communication. When a start signal is applied on the control terminals and/or the fieldbus, the frequency converter starts. The key can be selected as [1] Enable or [0] Disable via parameter 0-42 [Auto on] Key on LCP.

NOTICE!

An active HAND-OFF-AUTO signal via the digital inputs has higher priority than the control keys [Hand On] and [Auto On].

[Reset]

Is used to reset the frequency converter after an alarm (trip). It can be selected as [1] Enable or [0] Disable via parameter 0-43 [Reset] Key on LCP.

The parameter shortcut can be created by pressing [Main Menu] for 3 s. The parameter shortcut allows direct access to any parameter.

2.2.2 Quick Transfer of Parameter Settings between Multiple Frequency Converters

Once the set-up of a frequency converter is complete, store the data in the LCP or on a PC via MCT 10 Set-up Software.

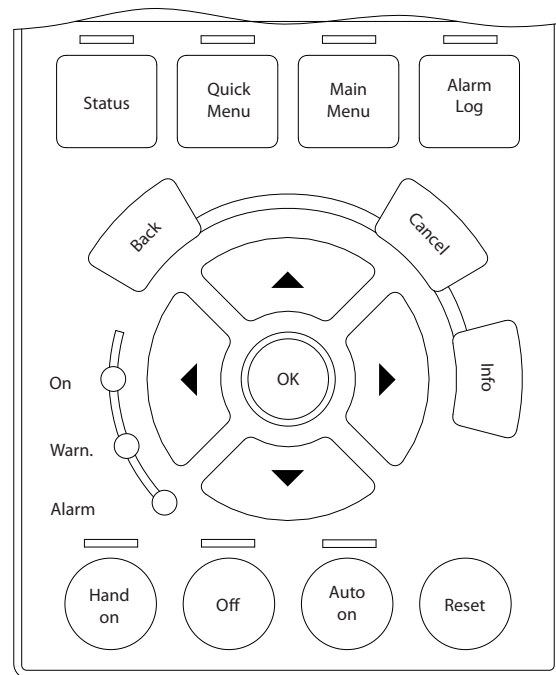

Figure 2.10 LCP

Data storage in LCP

NOTICE!

Stop the motor before performing this operation.

To store the data in the LCP:

1. Go to parameter 0-50 LCP Copy.
2. Press the [OK] key.
3. Select [1] All to LCP.
4. Press the [OK] key.

All parameter settings are now stored in the LCP indicated by the progress bar. When 100% is reached, press [OK].

Connect the LCP to another frequency converter and copy the parameter settings to this frequency converter as well.

2

Data transfer from LCP to frequency converter

NOTICE!

Stop the motor before performing this operation.

To transfer the data from the LCP to the frequency converter:

1. Go to *parameter 0-50 LCP Copy*.
2. Press the [OK] key.
3. Select [2] *All from LCP*.
4. Press the [OK] key.

The parameter settings stored in the LCP are now transferred to the frequency converter indicated by the progress bar. When 100% is reached, press [OK].

2.2.3 Display Mode

In normal operation, up to 5 different operating variables can be indicated continuously in the middle section: 1.1, 1.2, and 1.3, as well as 2 and 3.

2.2.4 Display Mode - Selection of Readouts

Press [Status] to toggle between 3 status readout screens. Operating variables with different formatting are shown in each status screen. For more information, see the examples in this chapter.

Several values or measurements can be linked to each of the shown operating variables. The values or measurements to be shown can be defined via the following parameters:

- *Parameter 0-20 Display Line 1.1 Small.*
- *Parameter 0-21 Display Line 1.2 Small.*
- *Parameter 0-22 Display Line 1.3 Small.*
- *Parameter 0-23 Display Line 2 Large.*
- *Parameter 0-24 Display Line 3 Large.*

Access the parameters via [Quick Menu], Q3 *Function Set-ups*, Q3-1 *General Settings*, Q3-13 *Display Settings*.

Each readout parameter selected in *parameter 0-20 Display Line 1.1 Small* to *parameter 0-24 Display Line 3 Large* has its own scale and digits after a decimal point. The higher numeric value of a parameter, the fewer digits are shown after the decimal point.

Example: Current readout 5.25 A; 15.2 A; 105 A.

See *parameter group 0-2* LCP Display* for further details.

Status screen I

This readout state is standard after start-up or initialization.

Press [Info] to obtain information about the measurement links to the shown operating variables (1.1, 1.2, 1.3, 2 and 3).

See the operating variables shown in *Figure 2.11*.

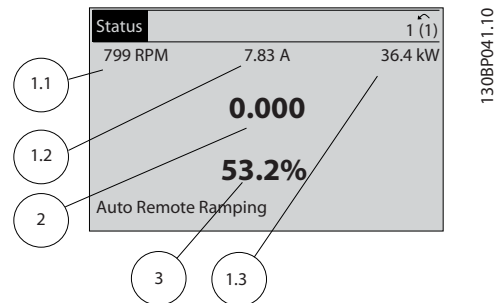

Figure 2.11 Status Screen I

Status screen II

See the operating variables (1.1, 1.2, 1.3, and 2) shown in *Figure 2.12*.

In the example, speed, motor current, motor power, and frequency are selected as variables in the first 2 lines.

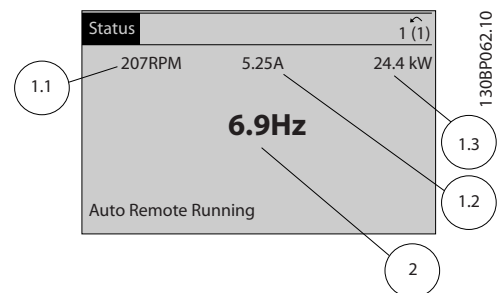

Figure 2.12 Status Screen II

Status screen III

This state shows the event and action of the smart logic control. For more information, see *parameter group 13-** Smart Logic*.

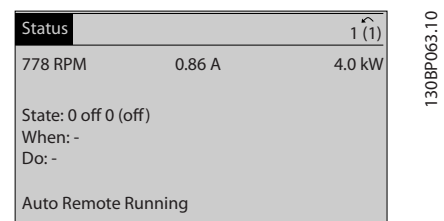

Figure 2.13 Status Screen III

2.2.5 Parameter Set-up

The frequency converter can be used for practically all assignments and offers 2 programming mode options:

- Main menu mode.
- Quick menu mode.

Main menu provides access to all parameters. Quick menu takes the user through a few parameters, making it possible to start operating the frequency converter. Change a parameter in either main menu mode or quick menu mode.

2.2.6 Quick Menu Key Functions

Press [Quick Menu] to enter a list of different areas contained in the *Quick Menu*. Select *Q1 My Personal Menu* to show the selected personal parameters. These parameters are selected in *parameter 0-25 My Personal Menu*. Up to 50 different parameters can be added in this menu.

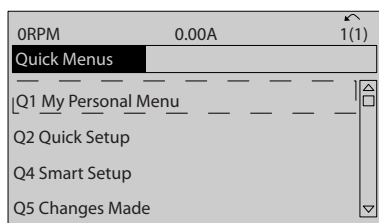

130BC916.10

Figure 2.14 Quick Menu

Select *Q2 Quick Setup* to go through a selection of parameters to get the motor running almost optimally. The default settings for the other parameters consider the required control functions and the configuration of signal inputs/outputs (control terminals).

2.2.7 Quick Menu, Q3 Function Set-ups

The function set-up provides quick access to all parameters required for most water and wastewater applications including:

- Variable torque.
- Constant torque.
- Pumps.
- Dosing pumps.
- Well pumps.
- Booster pumps.
- Mixer pumps.
- Aeration blowers.

The parameter selection is effected with the navigation keys. The parameters in *Table 2.1* are accessible.

Parameter	Setting
Parameter 0-01 Language	
Parameter 1-20 Motor Power [kW]	[kW]
Parameter 1-22 Motor Voltage	[V]
Parameter 1-23 Motor Frequency	[Hz]
Parameter 1-24 Motor Current	[A]
Parameter 1-25 Motor Nominal Speed	[RPM]
Parameter 5-12 Terminal 27 Digital Input	[0] No function ¹⁾
Parameter 1-29 Automatic Motor Adaptation (AMA)	[1] Enable complete AMA
Parameter 3-02 Minimum Reference	[RPM]
Parameter 3-03 Maximum Reference	[RPM]
Parameter 3-41 Ramp 1 Ramp-up Time	[s]
Parameter 3-42 Ramp 1 Ramp-down Time	[s]
Parameter 3-13 Reference Site	

Table 2.1 Selection of Parameter

1) If terminal 27 is set to [0] No function, no connection to +24 V on terminal 27 is necessary.

Select *Changes made* to get information about:

- The last 10 changes. Use the [▲] [▼] navigation keys to scroll between the last 10 changed parameters.
- The changes made since default setting.

Select *Loggings* to get information about the show line readouts. The information is shown as graphs. Only parameters selected in *parameter 0-20 Display Line 1.1 Small* and *parameter 0-24 Display Line 3 Large* can be viewed. It is possible to store up to 120 samples in the memory for later reference.

- Other pump.
- Fan applications.

Among other features, the function set-ups menu also includes parameters for selecting the following:

- Which variables to show on the LCP.
- Digital preset speeds.
- Scaling of analog references.
- Closed-loop single-zone and multi-zone applications.
- Specific functions related to water.
- Wastewater applications.

The function set-up parameters are grouped in the following way:

Q3-1 General settings			
Q3-10 Clock Settings	Q3-11 Display Settings	Q3-12 Analog Output	Q3-13 Relays
Parameter 0-70 Date and Time	Parameter 0-20 Display Line 1.1 Small	Parameter 6-50 Terminal 42 Output	Relay 1⇒Parameter 5-40 Function Relay
Parameter 0-71 Date Format	Parameter 0-21 Display Line 1.2 Small	Parameter 6-51 Terminal 42 Output Min Scale	Relay 2⇒Parameter 5-40 Function Relay
Parameter 0-72 Time Format	Parameter 0-22 Display Line 1.3 Small	Parameter 6-52 Terminal 42 Output Max Scale	Option relay 7⇒Parameter 5-40 Function Relay
Parameter 0-74 DST/Summertime	Parameter 0-23 Display Line 2 Large	–	Option relay 8⇒Parameter 5-40 Function Relay
Parameter 0-76 DST/Summertime Start	Parameter 0-24 Display Line 3 Large	–	Option relay 9⇒Parameter 5-40 Function Relay
Parameter 0-77 DST/Summertime End	Parameter 0-37 Display Text 1	–	–
–	Parameter 0-38 Display Text 2	–	–
–	Parameter 0-39 Display Text 3	–	–

Table 2.2 Q3-1 General Settings

Q3-2 Open-loop settings	
Q3-20 Digital reference	Q3-21 Analog reference
Parameter 3-02 Minimum Reference	Parameter 3-02 Minimum Reference
Parameter 3-03 Maximum Reference	Parameter 3-03 Maximum Reference
Parameter 3-10 Preset Reference	Parameter 6-10 Terminal 53 Low Voltage
Parameter 5-13 Terminal 29 Digital Input	Parameter 6-11 Terminal 53 High Voltage
Parameter 5-14 Terminal 32 Digital Input	Parameter 6-14 Terminal 53 Low Ref./Feedb. Value
Parameter 5-15 Terminal 33 Digital Input	Parameter 6-15 Terminal 53 High Ref./Feedb. Value

Table 2.3 Q3-2 Open-loop Settings

Q3-3 Closed-loop settings	
Q3-30 Feedback settings	Q3-31 PID settings
Parameter 1-00 Configuration Mode	Parameter 20-81 PID Normal/ Inverse Control
Parameter 20-12 Reference/Feedback Unit	Parameter 20-82 PID Start Speed [RPM]
Parameter 3-02 Minimum Reference	Parameter 20-21 Setpoint 1
Parameter 3-03 Maximum Reference	Parameter 20-93 PID Proportional Gain
Parameter 6-20 Terminal 54 Low Voltage	Parameter 20-94 PID Integral Time
Parameter 6-21 Terminal 54 High Voltage	
Parameter 6-24 Terminal 54 Low Ref./Feedb. Value	
Parameter 6-25 Terminal 54 High Ref./Feedb. Value	
Parameter 6-00 Live Zero Timeout Time	
Parameter 6-01 Live Zero Timeout Function	

Table 2.4 Q3-3 Closed-loop Settings

2.2.8 Quick Menu, Q4 SmartStart

SmartStart runs automatically on the first power-up of the frequency converter or after a reset to factory settings. SmartStart guides users through a series of steps to ensure the correct and most efficient motor control. SmartStart can also be started directly via the *Quick Menu*.

The following settings are available via SmartStart:

- **Single pump/motor:** In open loop or closed loop.
- **Motor alternation:** 2 motors share 1 frequency converter.
- **Basic cascade control:** Speed control of a single pump in a multi-pump system. For example, this can be a cost-effective solution in booster sets.
- **Master/slave:** Control of up to 8 frequency converters and pumps to ensure smooth operation of the overall pump system.

2.2.9 Main Menu Mode

Press [Main Menu] to enter the main menu mode. The readout in *Figure 2.15* appears on the display. The middle and bottom sections in the display show a list of parameter groups, which can be selected by toggling the [▲] and [▼] keys.

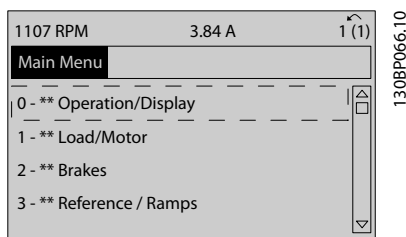

Figure 2.15 Main Menu Mode

Each parameter has a name and number, which remain the same regardless of the programming mode. In the main menu mode, the parameters are divided into groups. The first digit of the parameter number (from the left) indicates the parameter group number.

All parameters can be changed in the Main Menu. However, depending on the configuration (*parameter 1-00 Configuration Mode*), some parameters can be hidden. For example, open loop hides all the PID parameters, and other enabled options make more parameter groups visible.

2.2.10 Parameter Selection

In the main menu mode, the parameters are divided into groups. Select a parameter group with the navigation keys.

After selecting a parameter group, select a parameter with the navigation keys.

The middle section on the display shows the parameter number and name, and the selected parameter value.

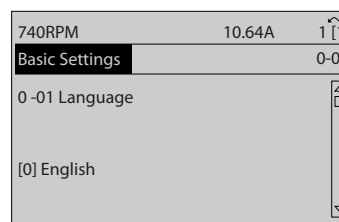

Figure 2.16 Parameter Selection

2.2.11 Changing Data

The procedure for changing data is the same in the quick menu mode and the main menu mode. Press [OK] to change the selected parameter.

The procedure for changing data depends on whether the selected parameter represents a numeric data value or a text value.

2.2.12 Changing a Text Value

If the selected parameter is a text value, change the text value with the [▲] [▼] keys.

Place the cursor on the value to save and press [OK].

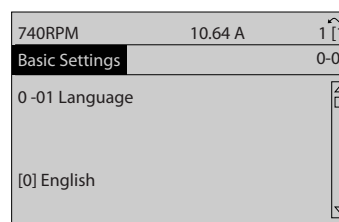

Figure 2.17 Changing a Text Value

2.2.13 Changing a Data Value

If the selected parameter shows a numeric data value, change the selected data value with the [◀] [▶] navigation keys and the [▲] [▼] navigation keys. Press [◀] [▶] keys to move the cursor horizontally.

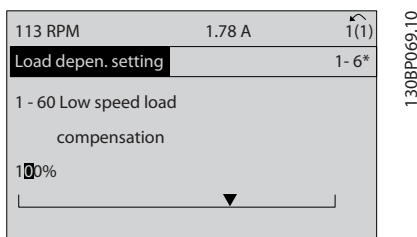

Figure 2.18 Changing a Data Value

Press the [▲] [▼] keys to change the data value. [▲] increases the data value, and [▼] decreases the data value. Place the cursor on the value to save and press [OK].

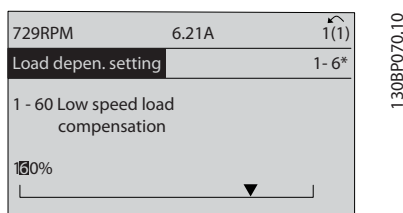

Figure 2.19 Saving a Data Value

2.2.14 Infinitely Variable Change of Numeric Data Value

If the selected parameter shows a numeric data value, select a digit with [◀] [▶].



Figure 2.20 Selecting a Digit

Change the selected digit infinitely variably with [▲] [▼]. The cursor indicates the selected digit. Place the cursor on the digit to save and press [OK].

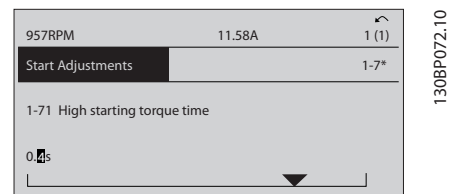

Figure 2.21 Saving

2.2.15 Value, Step by Step

Certain parameters can be changed step by step. This applies to:

- Parameter 1-20 Motor Power [kW].
- Parameter 1-22 Motor Voltage.
- Parameter 1-23 Motor Frequency.

The parameters are changed both as a group of numeric data values and as numeric data values that are infinitely varying.

2.2.16 Readout and Programming of Indexed Parameters

Parameters are indexed when placed in a rolling stack. Parameter 15-30 Fault Log: Error Code to parameter 15-32 Alarm Log: Time contain a fault log, which can be read out. Select a parameter, press [OK], and press the [▲] [▼] keys to scroll through the value log.

For example, parameter 3-10 Preset Reference is changed as follows:

1. Select the parameter, press [OK], and press [▲] [▼] to scroll through the indexed values.
2. To change the parameter value, select the indexed value and press [OK].
3. Change the value by pressing [▲] [▼].
4. Press [OK] to accept the new setting.
5. Press [Cancel] to abort. Press [Back] to leave the parameter.

2.2.17 How to Program on the Numerical Local Control Panel

The following instructions are valid for the numerical LCP (LCP 101).

The control panel is divided into 4 functional groups:

- Numerical display.
- Menu keys and indicator lights - changing parameters and switching between display functions.
- Navigation keys and indicator lights.
- Operation keys and indicator lights.

Display line

Status messages showing icons and numeric value.

Indicator lights

- Green LED/On: Indicates if control section is on.
- Yellow LED/Wrn: Indicates a warning.
- Flashing red LED/Alarm: Indicates an alarm.

LCP keys

[Menu]

Select 1 of the following modes:

- Status.
- Quick set-up.
- Main menu.

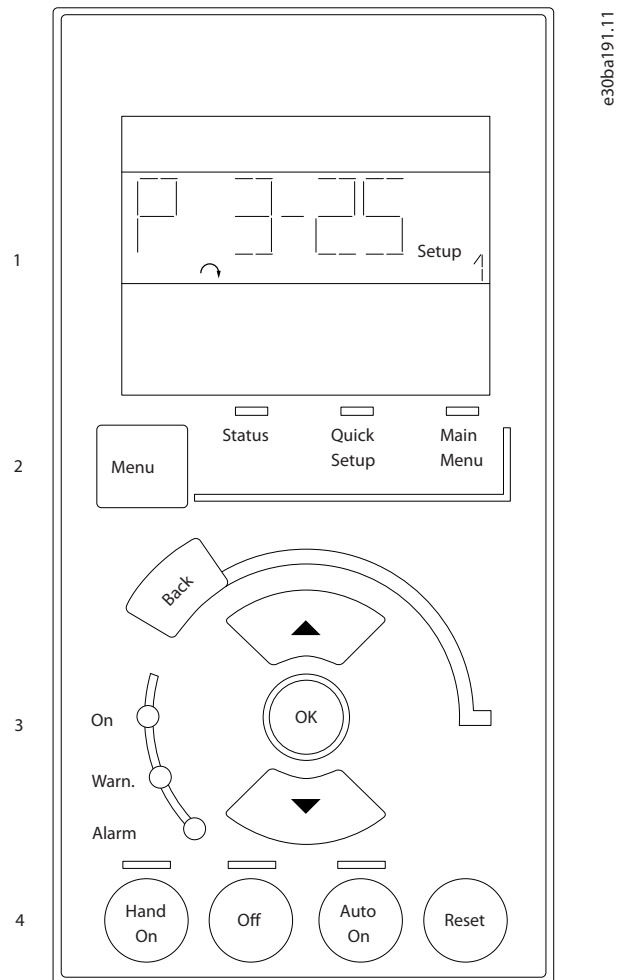

Figure 2.22 LCP Keys

Status mode

Status mode shows the status of the frequency converter or the motor.

If an alarm occurs, the NLCP automatically switches to status mode.

Several alarms can be shown.

NOTICE!

Parameter copy is not possible with LCP 101 numerical local control panel.



Figure 2.23 Status Mode



Figure 2.24 Alarm

Main Menu/Quick Set-up

Used for programming all parameters or only the parameters in the Quick Menu (see also description of the LCP 102 in *chapter 2.1 The Graphical and Numerical Local Control Panel*).

When the value flashes, press [▲] or [▼] to change parameter values.

1. Press [Main Menu] to select main menu.
2. Select the parameter group [xx-__] and press [OK].
3. Select the parameter [__-xx] and press [OK].
4. If the parameter is an array parameter, select the array number and press [OK].
5. Select the required data value and press [OK].

Parameters with functional options show values such as [1], [2], and so on. For a description of the different options, see the individual parameter descriptions in *chapter 3 Parameter Description*.

[Back]

Used for stepping backwards.

[▲] [▼] are used for maneuvering between commands and within parameters.

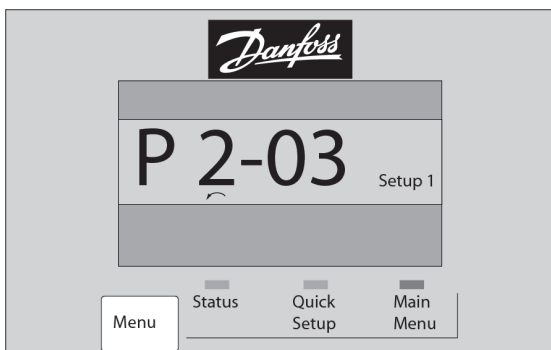

Figure 2.25 Main Menu/Quick Set-up

2.2.18 LCP Keys

Keys for local control are at the bottom of the LCP.

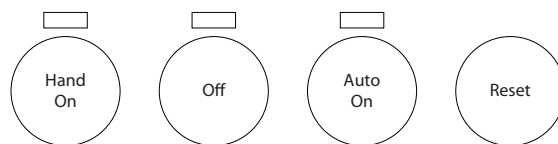

Figure 2.26 LCP Keys

[Hand On]

Enables control of the frequency converter via the LCP. [Hand On] also starts the motor and it is now possible to enter the motor speed data with the navigation keys. The key can be selected as [1] Enable or [0] Disable via *parameter 0-40 [Hand on] Key on LCP*.

External stop signals activated with control signals, or a fieldbus, override a start command via the LCP.

The following control signals are still active when [Hand On] is activated:

- [Hand On] - [Off] - [Auto On].
- Reset.
- Coast stop inverse.
- Reversing.
- Set-up select lsb - Set-up select msb.
- Stop command from serial communication.
- Quick stop.
- DC brake.

[Off]

Stops the connected motor. The key can be selected as [1] Enable or [0] Disable via *parameter 0-41 [Off] Key on LCP*.

If no external stop function is selected and the [Off] key is inactive, stop the motor by disconnecting the voltage.

[Auto On]

Enables control of the frequency converter via the control terminals and/or serial communication. When a start signal is applied on the control terminals and/or the bus, the frequency converter starts. The key can be selected as [1] *Enable* or [0] *Disable* via *parameter 0-42 [Auto on] Key on LCP*.

NOTICE!

An active **HAND-OFF-AUTO** signal via the digital inputs has higher priority than the control keys [Hand On] and [Auto On].

[Reset]

Used for resetting the frequency converter after an alarm (trip). It can be selected as [1] *Enable* or [0] *Disable* via *parameter 0-43 [Reset] Key on LCP*.

2.3.1 Initialization to Default Settings

Initialize the frequency converter to default settings in 2 ways.

Recommended initialization (via *parameter 14-22 Operation Mode*)

1. Select *parameter 14-22 Operation Mode*.
2. Press [OK].
3. Select [2] *initialization*.
4. Press [OK].
5. Disconnect the mains supply and wait until the display turns off.
6. Reconnect the mains supply. The frequency converter is now reset.

Parameter 14-22 Operation Mode initializes all except:

- *Parameter 14-50 RFI Filter*.
- *Parameter 8-30 Protocol*.
- *Parameter 8-31 Address*.
- *Parameter 8-32 FC Port Baud Rate*.
- *Parameter 8-35 Minimum Response Delay*.
- *Parameter 8-36 Max Response Delay*.
- *Parameter 8-37 Max Inter-Char Delay*.
- *Parameter 15-00 Operating hours* to *parameter 15-05 Over Volt's*.
- *Parameter 15-20 Historic Log: Event* to *parameter 15-22 Historic Log: Time*.
- *Parameter 15-30 Fault Log: Error Code* to *parameter 15-32 Alarm Log: Time*.

Manual initialization

1. Disconnect from mains and wait until the display turns off.
2.
 - 2a Press [Status] - [Main Menu] - [OK] at the same time while powering up the LCP 102, graphical display.
 - 2b Press [Menu] - [OK] while powering up the LCP 101, numerical display.
3. Release the keys after 5 s.
4. The frequency converter is now programmed according to default settings.

This procedure initializes all except:

- *Parameter 15-00 Operating hours*.
- *Parameter 15-03 Power Up's*.
- *Parameter 15-04 Over Temp's*.
- *Parameter 15-05 Over Volt's*.

NOTICE!

A manual initialization also resets serial communication, RFI filter settings (*parameter 14-50 RFI Filter*), and fault log settings.

3 Parameter Description

3

3.1 Parameter Selection

The parameters are grouped into various parameter groups for easy selection of the correct parameter for optimal operation of the frequency converter.

Overview of parameter groups

Group	Function
0-** Operation and Display	Parameters related to the basic functions of the frequency converter, function of the LCP keys, and configuration of the LCP display.
1-** Load and Motor	Parameters related to motor settings.
2-** Brakes	Parameters related to brake features in the frequency converter.
3-** Reference/Ramps	Parameters for the handling of reference, definitions of limitations, and configuration of the reaction of the frequency converter to changes.
4-** Limits/Warnings	Parameters for configuring limits and warnings.
5-** Digital In/Out	Parameters for configuring the digital inputs and outputs.
6-** Analog In/Out	Parameters for configuring the analog inputs and outputs.
8-** Communications and Options	Parameter group for configuring communications and options.
9-** PROFIBUS	Parameter group for Profibus-specific parameters (requires VLT® PROFIBUS DP MCA 101).
10-** CAN Fieldbus	Parameter group for DeviceNet-specific parameters (requires VLT® DeviceNet MCA 104).
13-** Smart Logic	Parameter group for smart logic control.
14-** Special Functions	Parameter group for configuring special frequency converter functions.
15-** Frequency Converter Information	Parameter group containing frequency converter information such as operating data, hardware configuration, and software versions.
16-** Data Readouts	Parameter group for data readouts, for example, actual references, voltages, control, alarm, warning, and status words.
18-** Data Readouts 2	This parameter group contains the last 10 preventive maintenance logs.
20-** FC Closed Loop	This parameter group is used for configuring the closed loop PID controller that controls the output frequency of the unit.
21-** Extended Closed Loop	Parameters for configuring the 3 extended closed loop PID controllers.
22-** Application Functions	Parameters for water applications.
23-** Time-based Functions	Parameters for actions to be performed on a daily or weekly basis.
24-** Application Functions 2	Parameters for the frequency converter bypass.
25-** Cascade Controller	Parameters for configuring the basic cascade controller for sequence control of multiple pumps.
26-** Analog I/O Option MCB 109	Parameters for configuring the VLT® Analog I/O Option MCB 109.
29-** Water Application Functions	Parameters for setting water-specific functions.
30-** Special Features	Parameters for configuring the special features.
31-** Bypass Option	Parameters for configuring the bypass function.
35-** Sensor Input Option	Parameters for configuring the sensor input function.

Table 3.1 Parameter Groups

Parameter descriptions and selections are shown in the graphical LCP or the numeric LCP. See *chapter 2 How to Program* for details. Access the parameters by pressing [Quick Menu] or [Main Menu] on the LCP. The *Quick Menu* is used primarily for commissioning the unit at start-up by providing the parameters necessary to start operation. The *Main Menu* provides access to all parameters for detailed application programming.

All digital input/output and analog input/output terminals are multifunctional. All terminals have factory default functions suitable for most water applications. If other special functions are required, they must be programmed in parameter groups 5-** *Digital In/out* or 6-** *Analog In/out*.

3.2 Parameters 0-** Operation and Display

Parameters related to the basic functions of the frequency converter, function of the LCP keys, and configuration of the LCP display.

3.2.1 0-0* Basic Settings

0-01 Language		
Option:	Function:	
		Defines the language to be used in the display. The frequency converter is delivered with 2 different language packages. English and German are included in both packages. English cannot be erased or manipulated.
[0] *	English	Part of language packages 1–2.
[1]	Deutsch	Part of language packages 1–2.
[2]	Francais	Part of language package 1.
[3]	Dansk	Part of language package 1.
[4]	Spanish	Part of language package 1.
[5]	Italiano	Part of language package 1.
[6]	Svenska	Part of language package 1.
[7]	Nederlands	Part of language package 1.
[10]	Chinese	Part of language package 2.
[20]	Suomi	Part of language package 1.
[22]	English US	Part of language package 1.
[27]	Greek	Part of language package 1.
[28]	Bras.port	Part of language package 1.
[36]	Slovenian	Part of language package 1.
[39]	Korean	Part of language package 2.
[40]	Japanese	Part of language package 2.
[41]	Turkish	Part of language package 1.
[42]	Trad.Chinese	Part of language package 2.
[43]	Bulgarian	Part of language package 1.
[44]	Srpski	Part of language package 1.
[45]	Romanian	Part of language package 1.
[46]	Magyar	Part of language package 1.
[47]	Czech	Part of language package 1.
[48]	Polski	Part of language package 1.
[49]	Russian	Part of language package 1.
[50]	Thai	Part of language package 2.

0-01 Language		
Option:	Function:	
[51]	Bahasa Indonesia	Part of language package 2.
[52]	Hrvatski	Part of language package 2.

0-02 Motor Speed Unit		
Option:	Function:	
		<p>NOTICE! This parameter cannot be adjusted while the motor is running.</p> <p>The information shown in the display depends on the settings in <i>parameter 0-02 Motor Speed Unit</i> and <i>parameter 0-03 Regional Settings</i>. The default settings of <i>parameter 0-02 Motor Speed Unit</i> and <i>parameter 0-03 Regional Settings</i> depend on to which region of the world the frequency converter is supplied.</p> <p>NOTICE! Changing the motor speed unit resets certain parameters to their initial value. Select the motor speed unit before modifying other parameters.</p>
[0] *	RPM	Select to show motor speed variables and parameters using motor speed (RPM).
[1]	Hz	Select to show motor speed variables and parameters using output frequency (Hz).

0-03 Regional Settings		
Option:	Function:	
		<p>NOTICE! This parameter cannot be adjusted while the motor is running.</p> <p>The display output depends on the settings in <i>parameter 0-02 Motor Speed Unit</i> and <i>parameter 0-03 Regional Settings</i>. The default settings of <i>parameter 0-02 Motor Speed Unit</i> and <i>parameter 0-03 Regional Settings</i> depend on which region of the world the frequency converter is supplied to. Reprogram the settings as required. The settings not used are made invisible.</p>
[0]	International	Sets <i>parameter 1-20 Motor Power [kW]</i> units to [kW] and the default value of <i>parameter 1-23 Motor Frequency</i> to 50 Hz.
[1]	North America	Sets <i>parameter 1-21 Motor Power [HP]</i> units to [hp] and the default value of <i>parameter 1-23 Motor Frequency</i> to 60 Hz.

0-04 Operating State at Power-up		
Option:	Function:	
		Select the operating mode after reconnection of the frequency converter to mains voltage after power-down when operating in hand-on (local) mode.
[0] *	Resume	Resumes operation of the frequency converter maintaining the same local reference and the same start/stop condition. The start/stop condition is applied by [Hand On]/[Off] on the LCP or local start via a digital input as before the frequency converter was powered down.
[1]	Forced stop, ref=old	Stops the frequency converter, but at the same time retains the local speed reference before power-down in the memory. After mains voltage is reconnected and after receiving a start command (pressing [Hand On] or local start command via a digital input), the frequency converter restarts and operates at the retained speed reference.

0-05 Local Mode Unit		
Option:	Function:	
		Defines if the local reference unit is shown in terms of the motor shaft speed (in RPM/Hz) or as percent.
[0] *	As Motor Speed Unit	
[1]	%	

3.2.2 0-1* Set-up Operations

Define and control the individual parameter set-ups. The frequency converter has 4 parameter set-ups that can be programmed independently of each other. This makes the frequency converter flexible in use and able to meet the requirements of many different water system control schemes often saving the cost of external control equipment. For example, the set-ups can be used to program the frequency converter to operate according to 1 control scheme in 1 set-up (for example daytime operation) and another control scheme in another set-up (for example night setback). Alternatively, they can be used by an air handling unit or an OEM unit to identically program all their factory-fitted frequency converters for different equipment models within a range to have the same parameters. During production/commissioning, select a specific set-up depending on the frequency converter model.

Select the active set-up (that is, the set-up in which the frequency converter is operating) in *parameter 0-10 Active Set-up*. The LCP then shows the selected active set-up.

Using multi set-up, it is possible to switch between set-ups with the frequency converter running or stopped, via digital input, or serial communication commands (for example for night setback). If it is necessary to change set-ups while running, ensure that *parameter 0-12 This Set-up Linked to* is programmed as required. For most water/wastewater applications, it is not necessary to program *parameter 0-12 This Set-up Linked to* even if change of set-up is required when running. However, for complex applications using the full flexibility of the multiple set-ups, it may be required. Using *parameter 0-11 Programming Set-up*, it is possible to edit parameters within any of the set-ups while continuing the frequency converter operation in its active set-up. The active set-up can be a different set-up to the one being edited. Using *parameter 0-51 Set-up Copy*, it is possible to copy parameter settings between the set-ups to enable quicker commissioning if similar parameter settings are required in different set-ups.

0-10 Active Set-up		
Option:	Function:	
		Select the set-up in which the frequency converter is to operate. Use <i>parameter 0-51 Set-up Copy</i> to copy a set-up to 1 or all other set-ups. To avoid conflicting settings of the same parameter within 2 different set-ups, link the set-ups using <i>parameter 0-12 This Set-up Linked to</i> . Stop the frequency converter before switching between set-ups where parameters marked <i>not changeable during operation</i> have different values. Parameters which are <i>not changeable during operation</i> are marked FALSE in <i>chapter 4 Parameter Lists</i> .
[0]	Factory setup	Cannot be changed. It contains the Danfoss data set and can be used as a data source when returning the other set-ups to a known state.
[1]	Set-up 1 *	[1] Set-up 1 to [4] Set-up 4 are the 4 parameter set-ups within which all parameters can be programmed.
[2]	Set-up 2	
[3]	Set-up 3	
[4]	Set-up 4	
[9]	Multi Set-up	Is used for remote set-up selections using digital inputs and the serial communication port. This set-up uses the settings from <i>parameter 0-12 This Set-up Linked to</i> .

0-11 Programming Set-up		
Option:	Function:	
		Select the set-up to be edited (that is programmed) during operation; either the active set-up or 1 of the inactive set-ups. The set-up number being edited is shown in the LCP in brackets.
[0]	Factory setup	Cannot be edited, but it is useful as a data source to return the other set-ups to a known state.
[1]	Set-up 1	[1] Set-up 1 to [4] Set-up 4 can be edited freely during operation, independently of the active set-up.
[2]	Set-up 2	
[3]	Set-up 3	
[4]	Set-up 4	
[9] *	Active Set-up	The set-up in which the frequency converter is operating can be edited during operation. Editing parameters in the selected set-up would normally be done from the LCP, but it is also possible from any of the serial communication ports.

0-12 This Set-up Linked to		
Option:	Function:	
		Use this parameter only if a change of set-ups is required while the motor is running. This parameter ensures that parameters which are not changeable during operation have the same setting in all relevant set-ups. To enable conflict-free changes from 1 set-up to another while the frequency converter is running, link set-ups containing parameters which are not changeable during operation. The link ensures synchronizing of the <i>not changeable during operation</i> parameter values when moving from 1 set-up to another during operation. Parameters marked with FALSE in the parameter lists (in <i>chapter 4 Parameter Lists</i>) cannot be changed while the frequency converter is running. The <i>parameter 0-12 This Set-up Linked to</i> feature is used when [9] <i>Multi set-up</i> in <i>parameter 0-10 Active Set-up</i> is selected. Use [9] <i>Multi set-up</i> to move from 1 set-up to another during operation while the motor is running. For example: Use [9] <i>Multi set-up</i> to shift from set-up 1 to set-up 2 while the motor is running. Program parameters in set-up 1 first, then ensure that set-up 1 and set-up 2 are synchronized (or linked).

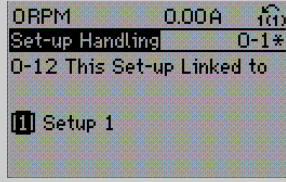
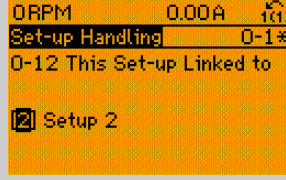
0-12 This Set-up Linked to		
Option:	Function:	
		<p>Synchronization can be performed in 2 ways:</p> <ul style="list-style-type: none"> Change the edit set-up to [2] <i>Set-up 2</i> in <i>parameter 0-11 Programming Set-up</i> and set <i>parameter 0-12 This Set-up Linked to</i> to [1] <i>Set-up 1</i>. This starts the linking (synchronizing) process.  <p>Figure 3.1 Set-up Handling</p> <ul style="list-style-type: none"> While still in set-up 1, using <i>parameter 0-50 LCP Copy</i>, copy set-up 1 to set-up 2. Then set <i>parameter 0-12 This Set-up Linked to</i> to [2] <i>Set-up 2</i>. This starts the linking process.  <p>Figure 3.2 Set-up Handling</p> <p>After the link is complete, <i>parameter 0-13 Readout: Linked Set-ups</i> reads set-ups 1 and 2 to indicate that all <i>not changeable during operation</i> parameters are now the same in set-up 1 and set-up 2. If there are changes to a <i>not changeable during operation</i> parameter in set-up 2, for example <i>parameter 1-30 Stator Resistance (Rs)</i>, they are also changed automatically in set-up 1. A switch between set-up 1 and set-up 2 during operation is now possible.</p>
[0] *	Not linked	
[1]	Set-up 1	
[2]	Set-up 2	
[3]	Set-up 3	
[4]	Set-up 4	

0-13 Readout: Linked Set-ups													
Array [5]													
Range:	Function:												
0* [0 - 255]	View a list of all the set-ups linked by <i>parameter 0-12 This Set-up Linked to</i> . The parameter has 1 index for each parameter set-up. The value for each index shows which set-ups are linked to that parameter set-up.												
	<table border="1"> <thead> <tr> <th>Index</th> <th>LCP value</th> </tr> </thead> <tbody> <tr> <td>0</td> <td>{0}</td> </tr> <tr> <td>1</td> <td>{1,2}</td> </tr> <tr> <td>2</td> <td>{1,2}</td> </tr> <tr> <td>3</td> <td>{3}</td> </tr> <tr> <td>4</td> <td>{4}</td> </tr> </tbody> </table>	Index	LCP value	0	{0}	1	{1,2}	2	{1,2}	3	{3}	4	{4}
Index	LCP value												
0	{0}												
1	{1,2}												
2	{1,2}												
3	{3}												
4	{4}												
Table 3.2 Set-up Link Example													

0-14 Readout: Prog. Set-ups / Channel	
Range:	Function:
0* [-2147483648 - 2147483647]	View the setting of <i>parameter 0-11 Programming Set-up</i> for each of the 4 different communication channels. When the number is shown in hex, as it is in the LCP, each number shows 1 channel. Numbers 1–4 show a set-up number; F stands for the factory setting, and A stands for an active set-up. The channels are, from right to left: LCP, fieldbus, USB, HPFB1.5. Example: The value AAAAAA21h means that the fieldbus channel uses set-up 2 in <i>parameter 0-11 Programming Set-up</i> , the LCP uses set-up 1, and all other channels use the active set-up.

3.2.3 0-2* LCP Display

Define the variables shown in the LCP.

NOTICE!

For information on how to write display texts, refer to:

- *Parameter 0-37 Display Text 1.*
- *Parameter 0-38 Display Text 2.*
- *Parameter 0-39 Display Text 3.*

0-20 Display Line 1.1 Small	
Option:	Function:
	Select a variable to show in line 1, left position.

0-20 Display Line 1.1 Small		
Option:	Function:	
[0]	None	No display value selected
[953]	Profibus Warning Word	Shows PROFIBUS communication warnings.
[1005]	Readout Transmit Error Counter	Shows the number of CAN control transmission errors since the last power-up.
[1006]	Readout Receive Error Counter	Shows the number of CAN control receipt errors since the last power-up.
[1007]	Readout Bus Off Counter	Shows the number of bus-off events since the last power-up.
[1013]	Warning Parameter	Shows a DeviceNet-specific warning word. One separate bit is assigned to every warning.
[1230]		
[1472]		
[1473]		
[1474]		
[1501]	Running Hours	View the number of running hours of the motor.
[1502]	kWh Counter	View the mains power consumption in kWh.
[1600]	Control Word	View the control word sent from the frequency converter via the serial communication port in hex code.
[1601]	Reference [Unit]	Total reference (sum of digital, analog, preset, bus, freeze reference, catch up, and slow down) in selected unit.
[1602]	Reference %	Total reference (sum of digital, analog, preset, bus, freeze reference, catch up, and slow down) in percent.
[1603]	Status Word	Present status word.
[1605]	Main Actual Value [%]	One or more warnings in hex code.
[1609]	Custom Readout	View the user-defined readouts as defined in: <ul style="list-style-type: none"> • <i>Parameter 0-30 Custom Readout Unit.</i> • <i>Parameter 0-31 Custom Readout Min Value.</i> • <i>Parameter 0-32 Custom Readout Max Value.</i>
[1610]	Power [kW]	Actual power consumed by the motor in kW.
[1611]	Power [hp]	Actual power consumed by the motor in hp.

0-20 Display Line 1.1 Small		
Option:	Function:	
[1612]	Motor voltage	Voltage supplied to the motor.
[1613]	Frequency	Motor frequency, that is the output frequency from the frequency converter in Hz.
[1614]	Motor Current	Phase current of the motor measured as effective value.
[1615]	Frequency [%]	Motor frequency, that is the output frequency from the frequency converter in percent.
[1616]	Torque [Nm]	Present motor load as a percentage of the rated motor torque.
[1617]	Speed [RPM]	Speed in RPM (revolutions per minute), that is the motor shaft speed in closed loop based on the entered motor nameplate data, the output frequency, and the load on the frequency converter.
[1618]	Motor Thermal	Thermal load on the motor calculated by the ETR function. See also <i>parameter group 1-9* Motor Temperature</i> .
[1619]	KTY sensor temperature	
[1620]	Motor Angle	
[1622]	Torque [%]	Shows the actual torque produced in percentage.
[1625]		
[1630]	DC Link Voltage	DC-link voltage in the frequency converter.
[1632]	Brake Energy /s	Present brake power transferred to an external brake resistor. Shows an instant value.
[1633]	Brake Energy /2 min	Brake power transferred to an external brake resistor. The average power is calculated continuously for the most recent 120 s.
[1634]	Heatsink Temp.	Present heat sink temperature of the frequency converter. The cutout limit is 95 ±5 °C. Cutting back in occurs at 70 ±5 °C.
[1635]	Inverter Thermal	Percentage load of the inverters.
[1636]	Inv. Nom. Current	Nominal current of the frequency converter.
[1637]	Inv. Max. Current	Maximum current of the frequency converter.

0-20 Display Line 1.1 Small		
Option:	Function:	
[1638]	SL Controller State	State of the event executed by the control.
[1639]	Control Card Temp.	Temperature of the control card.
[1650]	External Reference	Sum of the external reference as a percentage, that is the sum of analog, pulse, and bus.
[1651]	Pulse Reference	
[1652]	Feedback [Unit]	Signal value in units from the programmed digital inputs.
[1653]	Digi Pot Reference	View the contribution of the digital potentiometer to the actual reference feedback.
[1660]	Digital Input	Shows the status of the digital inputs. Signal low=0, signal high=1. Regarding order, see <i>parameter 16-60 Digital Input</i> . Bit 0 is at the extreme right.
[1661]	Terminal 53 Switch Setting	Setting of input terminal 53. Current=0, voltage=1.
[1662]	Analog Input 53	Actual value at input 53 either as a reference or protection value.
[1663]	Terminal 54 Switch Setting	Setting of input terminal 54. Current=0, voltage=1.
[1664]	Analog Input 54	Actual value at input 54 either as reference or protection value.
[1665]	Analog Output 42 [mA]	Actual value at output 42 in mA. Use <i>parameter 6-50 Terminal 42 Output</i> to select the variable to be show in output 42.
[1666]	Digital Output [bin]	Binary value of all digital outputs.
[1667]	Freq. Input #29 [Hz]	Actual value of the frequency applied at terminal 29 as a pulse input.
[1668]	Freq. Input #33 [Hz]	Actual value of the frequency applied at terminal 33 as a pulse input.
[1669]	Pulse Output #27 [Hz]	Actual value of pulses applied to terminal 27 in digital output mode.
[1670]	Pulse Output #29 [Hz]	Actual value of pulses applied to terminal 29 in digital output mode.
[1671]	Relay Output [bin]	View the setting of all relays.
[1672]	Counter A	View the present value of counter A.
[1673]	Counter B	View the present value of counter B.

0-20 Display Line 1.1 Small		
Option:	Function:	
[1674]	Prec. Stop Counter	
[1675]	Analog In X30/11	Actual value of the signal on input X30/11 (VLT® General Purpose I/O MCB 101, optional).
[1676]	Analog In X30/12	Actual value of the signal on input X30/12 (VLT® General Purpose I/O MCB 101, optional).
[1677]	Analog Out X30/8 [mA]	Actual value at output X30/8 (VLT® General Purpose I/O MCB 101, optional). Use <i>parameter 6-60 Terminal X30/8 Output</i> to select the variable to be shown.
[1678]		
[1679]		
[1680]	Fieldbus CTW 1	Control word (CTW) received from the fieldbus.
[1682]	Fieldbus REF 1	Main reference value sent with control word via the serial communications network, for example, from the BMS, PLC, or another controller.
[1684]	Comm. Option Status	Extended fieldbus communication option status word.
[1685]	FC Port CTW 1	Control word (CTW) received from the fieldbus.
[1686]	FC Port REF 1	Status word (STW) sent to the fieldbus.
[1690]	Alarm Word	One or more alarms in hex code (used for serial communication).
[1691]	Alarm word 2	One or more alarms in hex code (used for serial communication).
[1692]	Warning Word	One or more warnings in hex code (used for serial communication).
[1693]	Warning word 2	One or more warnings in hex code (used for serial communication).
[1694]	Ext. Status Word	One or more status conditions in hex code (used for serial communication).
[3401]	PCD 1 Write to MCO	
[3402]	PCD 2 Write to MCO	
[3403]	PCD 3 Write to MCO	
[3404]	PCD 4 Write to MCO	
[3405]	PCD 5 Write to MCO	

0-20 Display Line 1.1 Small		
Option:	Function:	
[3406]	PCD 6 Write to MCO	
[3407]	PCD 7 Write to MCO	
[3408]	PCD 8 Write to MCO	
[3409]	PCD 9 Write to MCO	
[3410]	PCD 10 Write to MCO	
[3421]	PCD 1 Read from MCO	
[3422]	PCD 2 Read from MCO	
[3423]	PCD 3 Read from MCO	
[3424]	PCD 4 Read from MCO	
[3425]	PCD 5 Read from MCO	
[3426]	PCD 6 Read from MCO	
[3427]	PCD 7 Read from MCO	
[3428]	PCD 8 Read from MCO	
[3429]	PCD 9 Read from MCO	
[3430]	PCD 10 Read from MCO	
[3440]	Digital Inputs	
[3441]	Digital Outputs	
[3450]	Actual Position	
[3451]	Commanded Position	
[3452]	Actual Master Position	
[3453]	Slave Index Position	
[3454]	Master Index Position	
[3455]	Curve Position	
[3456]	Track Error	
[3457]	Synchronizing Error	
[3458]	Actual Velocity	
[3459]	Actual Master Velocity	
[3460]	Synchronizing Status	

0-20 Display Line 1.1 Small		
Option:	Function:	
[3461]	Axis Status	
[3462]	Program Status	
[3470]	MCO Alarm Word 1	
[3471]	MCO Alarm Word 2	
[9913]		
[9914]		
[9920]		
[9921]		
[9922]		
[9923]		
[9924]		
[9925]		
[9926]		
[9927]		

0-21 Display Line 1.2 Small

The options are the same as those listed for *parameter 0-20 Display Line 1.1 Small*. Select a variable to show in line 1, center position.

0-22 Display Line 1.3 Small

The options are the same as those listed for *parameter 0-20 Display Line 1.1 Small*. Select a variable to show in line 1, right position.

0-23 Display Line 2 Large

The options are the same as those listed for *parameter 0-20 Display Line 1.1 Small*. Select a variable to show in line 2.

0-24 Display Line 3 Large

The options are the same as those listed for *parameter 0-20 Display Line 1.1 Small*. Select a variable to show in line 2.

0-25 My Personal Menu

Array [50]		
Range:	Function:	
0 N/A* 9999 N/A]	[0 - 9999 N/A]	Define up to 20 parameters to appear in the <i>Q1 Personal Menu</i> , accessible via the [Quick Menu] key on the LCP. The parameters are shown in the <i>Q1 Personal Menu</i> in the order they are programmed into this array parameter. Delete parameters by setting the value to 0000. For example, this can be used to provide quick, simple access to just 1 or up to 50 parameters which require changing regularly.

3.2.4 0-3* LCP Custom Readout

It is possible to customize the display elements for various purposes:

- Custom readout. Value proportional to speed (linear, squared, or cubed depending on unit selected in *parameter 0-30 Custom Readout Unit*).
- Display text. Text string stored in a parameter.

Custom readout

The calculated value to be shown is based on the settings in:

- *Parameter 0-30 Custom Readout Unit*.
- *Parameter 0-31 Custom Readout Min Value* (linear only).
- *Parameter 0-32 Custom Readout Max Value*.
- *Parameter 4-13 Motor Speed High Limit [RPM]*.
- *Parameter 4-14 Motor Speed High Limit [Hz]*.
- Actual speed.

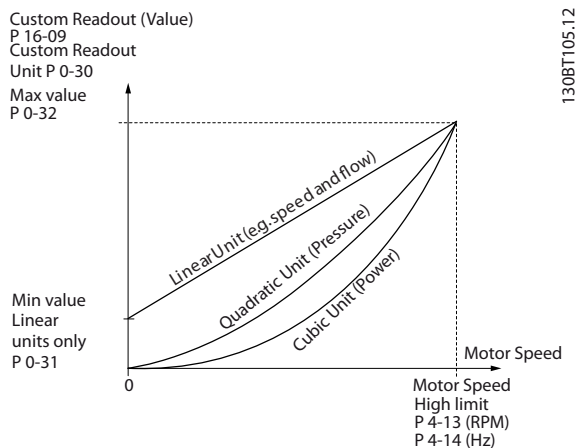

Figure 3.3 Custom Readout

The relation depends on the type of unit selected in *parameter 0-30 Custom Readout Unit*:

Unit type	Speed relation
Dimensionless	Linear
Speed	
Flow, volume	
Flow, mass	
Velocity	
Length	
Temperature	
Pressure	Quadratic
Power	Cubic

Table 3.3 Speed Relations for Different Unit Types

0-30 Custom Readout Unit	
Option:	Function:
	Program a value to be shown in the LCP display. The value has a linear, squared, or cubed relation to speed. This relation depends on the unit selected (see <i>Table 3.3</i>). The actual calculated value can be read in <i>parameter 16-09 Custom Readout</i> , and/or shown in the display by selecting <i>[1609] Custom Readout</i> in <i>parameter 0-20 Display Line 1.1 Small</i> to <i>parameter 0-24 Display Line 3 Large</i> .
[0]	
[1] *	%
[5]	PPM
[10]	1/min
[11]	RPM
[12]	Pulse/s
[20]	l/s
[21]	l/min
[22]	l/h
[23]	m ³ /s
[24]	m ³ /min
[25]	m ³ /h
[30]	kg/s
[31]	kg/min
[32]	kg/h
[33]	t/min
[34]	t/h
[40]	m/s
[41]	m/min
[45]	m
[60]	°C
[70]	mbar
[71]	bar
[72]	Pa

0-30 Custom Readout Unit	
Option:	Function:
[73]	kPa
[74]	m WG
[75]	mm Hg
[80]	kW
[120]	GPM
[121]	gal/s
[122]	gal/min
[123]	gal/h
[124]	CFM
[125]	ft ³ /s
[126]	ft ³ /min
[127]	ft ³ /h
[130]	lb/s
[131]	lb/min
[132]	lb/h
[140]	ft/s
[141]	ft/min
[145]	ft
[160]	°F
[170]	psi
[171]	lb/in ²
[172]	in WG
[173]	ft WG
[174]	in Hg
[180]	HP

0-31 Custom Readout Min Value		
Range:	Function:	
Size related*	[-999999.99 - 100.00 CustomReadoutUnit]	This parameter allows selection of the minimum value of the custom-defined readout (occurs at zero speed). It is only possible to select a value different from 0 when selecting a linear unit in <i>parameter 0-30 Custom Readout Unit</i> . For quadratic and cubic units, the minimum value is 0.

0-32 Custom Readout Max Value		
Range:	Function:	
100 Custom-ReadoutUnit*	[par. 0-31 - 999999.99 CustomReadoutUnit]	This parameter sets the maximum value to be shown when the speed of the motor has reached the set value for <i>parameter 4-13 Motor Speed High Limit [RPM]</i> or <i>parameter 4-14 Motor Speed High Limit [Hz]</i> (depends on setting in <i>parameter 0-02 Motor Speed Unit</i>).

0-37 Display Text 1		
Range:	Function:	
0* [0 - 25]	<p>In this parameter, it is possible to write an individual text string to be shown in the LCP or to be read via serial communication.</p> <p>To show the text permanently, select [37] <i>Display Text 1</i> in 1 of the following parameters:</p> <ul style="list-style-type: none"> Parameter 0-20 <i>Display Line 1.1 Small</i>. Parameter 0-21 <i>Display Line 1.2 Small</i>. Parameter 0-22 <i>Display Line 1.3 Small</i>. Parameter 0-23 <i>Display Line 2 Large</i>. Parameter 0-24 <i>Display Line 3 Large</i>. Parameter 0-37 <i>Display Text 1</i>. <p>Changing <i>parameter 12-08 Host Name</i> changes <i>parameter 0-37 Display Text 1</i> - but not the opposite way.</p>	

0-38 Display Text 2		
Range:	Function:	
0* [0 - 25]	<p>In this parameter, it is possible to write an individual text string to be shown in the LCP or to be read via serial communication.</p> <p>To show the text permanently, select [38] <i>Display Text 2</i> in:</p> <ul style="list-style-type: none"> Parameter 0-20 <i>Display Line 1.1 Small</i>. Parameter 0-21 <i>Display Line 1.2 Small</i>. Parameter 0-22 <i>Display Line 1.3 Small</i>. Parameter 0-23 <i>Display Line 2 Large</i>. Parameter 0-24 <i>Display Line 3 Large</i>. <p>Press [▲] or [▼] to change a character. Press [◀] and [▶] to move the cursor. When a character is highlighted by the cursor, this character can be changed. A character can be inserted by placing the cursor between 2 characters and pressing [▲] or [▼].</p>	

0-39 Display Text 3		
Range:	Function:	
0* [0 - 25]	<p>In this parameter, it is possible to write an individual text string to show in the LCP or to be read via serial communication. To show the text permanently, select display text 3 in <i>parameter 0-20 Display Line 1.1 Small</i>, <i>parameter 0-21 Display Line 1.2 Small</i>, <i>parameter 0-22 Display Line 1.3 Small</i>, <i>parameter 0-23 Display Line 2 Large</i>, or <i>parameter 0-24 Display Line 3 Large</i>. Press [▲] or [▼] to change a character. Press [◀] and [▶] to move the cursor. When a character is highlighted by the cursor, this character can be changed. A character</p>	

0-39 Display Text 3		
Range:	Function:	
	<p>can be inserted by placing the cursor between 2 characters and pressing [▲] or [▼].</p>	

3.2.5 0-4* LCP Keypad

Enable, disable, and password protect individual keys on the LCP.

0-40 [Hand on] Key on LCP		
Option:	Function:	
[0]	Disabled	Select to disable the key.
[1] *	Enabled	[Hand On] key is enabled.
[2]	Password	Avoid unauthorized start in hand-on mode. If <i>parameter 0-40 [Hand on] Key on LCP</i> is included in <i>My Personal Menu</i> , define the password in <i>parameter 0-65 Personal Menu Password</i> . Otherwise, define the password in <i>parameter 0-60 Main Menu Password</i> .
[3]	Enabled without OFF	
[4]	Password without OFF	
[5]	Enabled with OFF	
[6]	Password with OFF	
[9]	Enabled, ref = 0	

0-41 [Off] Key on LCP		
Option:	Function:	
[0]	Disabled	Select to disable the key.
[1] *	Enabled	[Off] key is enabled.
[2]	Password	Avoid unauthorized stop. If <i>parameter 0-41 [Off] Key on LCP</i> is included in <i>My Personal Menu</i> , define the password in <i>parameter 0-65 Personal Menu Password</i> . Otherwise, define the password in <i>parameter 0-60 Main Menu Password</i> .

0-42 [Auto on] Key on LCP		
Option:	Function:	
[0]	Disabled	Select to disable the key.
[1] *	Enabled	[Auto On] key is enabled.
[2]	Password	Avoid unauthorized start in auto-on mode. If <i>parameter 0-42 [Auto on] Key on LCP</i> is included in <i>My Personal Menu</i> , define the password in <i>parameter 0-65 Personal Menu Password</i> . Otherwise, define the password in <i>parameter 0-60 Main Menu Password</i> .

0-43 [Reset] Key on LCP		
Option:	Function:	
[0]	Disabled	Select to disable the key.
[1] *	Enabled	[Reset] key is enabled.
[2]	Password	Avoid unauthorized resetting. If <i>parameter 0-43 [Reset] Key on LCP</i> is included in <i>parameter 0-25 My Personal Menu</i> , define the password in <i>parameter 0-65 Personal Menu Password</i> . Otherwise, define the password in <i>parameter 0-60 Main Menu Password</i> .
[3]	Enabled without OFF	
[4]	Password without OFF	
[5]	Enabled with OFF	Pressing the key resets the frequency converter, but does not start it.
[6]	Password with OFF	Prevents unauthorized reset. After authorized reset, the frequency converter does not start. See option [2] <i>Password</i> for information on how to set the password.

0-44 [Off/Reset] Key on LCP		
Enable or disable the [Off/Reset] key.		
Option:	Function:	
[0]	Disabled	
[1] *	Enabled	
[2]	Password	

0-45 [Drive Bypass] Key on LCP		
Press [Off] and select [0] <i>Disabled</i> to avoid unintended stop of the frequency converter. Press [Off] and select [2] <i>Password</i> to avoid unauthorized bypass of the frequency converter. If <i>parameter 0-45 [Drive Bypass] Key on LCP</i> is included in the <i>Quick Menu</i> , define the password in <i>parameter 0-65 Personal Menu Password</i> .		
Option:	Function:	
[0]	Disabled	Select to disable the key.
[1] *	Enabled	
[2]	Password	

3.2.6 0-5* Copy/Save

Copy parameters from and to the LCP. Use these parameters for saving and copying set-ups from 1 frequency converter to another.

0-50 LCP Copy		
Option:	Function:	
		NOTICE! This parameter cannot be adjusted while the motor is running.
[0] *	No copy	
[1]	All to LCP	Copies all parameters in all set-ups from the frequency converter memory to the LCP memory. For service purposes, copy all parameters to the LCP after commissioning.
[2]	All from LCP	Copies all parameters in all set-ups from the LCP memory to the frequency converter memory.
[3]	Size indep. from LCP	Copies only the parameters that are independent of the motor size. Use the latest selection to program several frequency converters with the same function without disturbing motor data which is already set.
[10]	Delete LCP copy data	

0-51 Set-up Copy		
Option:	Function:	
[0] *	No copy	No function.
[1]	Copy to set-up 1	Copies all parameters in the present programming set-up (defined in <i>parameter 0-11 Programming Set-up</i>) to set-up 1.
[2]	Copy to set-up 2	Copies all parameters in the present programming set-up (defined in <i>parameter 0-11 Programming Set-up</i>) to set-up 2.
[3]	Copy to set-up 3	Copies all parameters in the present programming set-up (defined in <i>parameter 0-11 Programming Set-up</i>) to set-up 3.
[4]	Copy to set-up 4	Copies all parameters in the present programming set-up (defined in <i>parameter 0-11 Programming Set-up</i>) to set-up 4.
[9]	Copy to all	Copies the parameters in the present set-up to each of the set-ups 1 to 4.

3.2.7 0-6* Password

0-60 Main Menu Password		
Range:	Function:	
100* [-9999 - 9999]	Define the password for access to the Main Menu via the [Main Menu] key. If <i>parameter 0-61 Access to Main Menu w/o Password</i> is set to [0] Full access, this parameter is ignored.	

0-61 Access to Main Menu w/o Password		
Option:	Function:	
[0] * Full access	Disables the password defined in <i>parameter 0-60 Main Menu Password</i> . If this option is selected, <i>parameter 0-60 Main Menu Password</i> , <i>parameter 0-65 Personal Menu Password</i> , and <i>parameter 0-66 Access to Personal Menu w/o Password</i> are ignored.	
[1]	LCP: Read only	Prevents unauthorized editing of <i>Main Menu</i> parameters.
[2]	LCP: No access	Prevents unauthorized viewing and editing of <i>Main Menu</i> parameters.
[3]	Bus: Read only	Provides read-only access to parameters via fieldbus.
[4]	Bus: No access	Disables access to parameters via fieldbus.
[5]	All: Read only	Prevents unauthorized editing of <i>Main Menu</i> parameters and provides read-only access to parameters via fieldbus.

0-61 Access to Main Menu w/o Password		
Option:	Function:	
[6]	All: No access	Prevents unauthorized viewing and editing of <i>Main Menu</i> parameters and disables access to parameters via fieldbus.

0-65 Personal Menu Password		
Range:	Function:	
200* [-9999 - 9999]	Define the password for access to <i>My Personal Menu</i> via the [Quick Menu] key. If <i>parameter 0-66 Access to Personal Menu w/o Password</i> is set to [0] Full access, this parameter is ignored.	

0-66 Access to Personal Menu w/o Password		
If <i>parameter 0-61 Access to Main Menu w/o Password</i> is set to [0] Full access, this parameter is ignored.		
Option:	Function:	
[0] * Full access	Disables the password defined in <i>parameter 0-65 Personal Menu Password</i> .	
[1]	LCP: Read only	Prevents unauthorized editing of <i>My Personal Menu</i> parameters.
[3]	Bus: Read only	
[5]	All: Read only	

0-67 Bus Password Access		
Range:	Function:	
0 N/A* [0 - 9999 N/A]	Writing to this parameter enables unlocking of the frequency converter from bus/MCT 10 Set-up Software.	

3.2.8 0-7* Clock Settings

Set the time and date of the internal clock. For example, the internal clock can be used for:

- Timed actions.
- Energy log.
- Trend analysis.
- Date/time stamps on alarms.
- Logged data.
- Preventive maintenance.

It is possible to program the clock for daylight saving time/summer time, weekly working days/non-working days, including 20 exceptions (holidays, and so on). Although the clock settings can be set via the LCP, they can also be set along with timed actions and preventive maintenance functions using the MCT 10 Set-up Software tool.

NOTICE!

The frequency converter has no back-up of the clock function and the set date/time resets to default (01.01.2007 00:00 Mon) after a power-down, unless a real-time clock-module with back-up is installed. If no module with back-up is installed, only use the clock function if the frequency converter is integrated into an external system using serial communication, with the system maintaining synchronization of control equipment clock times. In *parameter 0-79 Clock Fault*, it is possible to program a warning if the clock has not been set properly, for example, after a power-down.

NOTICE!

When mounting VLT® Analog I/O Option MCB 109 or VLT® Real-time Clock MCB 117, a battery back-up of the date and time is included.

0-70 Date and Time		
Range:	Function:	
Size related*	[0 - 0]	Sets the date and time of the internal clock. The format to be used is set in <i>parameter 0-71 Date Format</i> and <i>parameter 0-72 Time Format</i> . When using VLT® Real-time Clock MCB 117, the time is synchronized at 15:00 every day.

0-71 Date Format		
Option:	Function:	
[0]	YYYY-MM-DD	Sets the date format to be used in the LCP.
[1]	DD-MM-YYYY	Sets the date format to be used in the LCP.
[2]	MM/DD/YYYY	Sets the date format to be used in the LCP.

0-72 Time Format		
Option:	Function:	
		Sets the time format to be used in the LCP.
[0]	24 h	
[1]	12 h	

0-73 Time Zone Offset		
Range:	Function:	
0 min*	[-780 - 780 min]	Enter the time zone offset relative to UTC. This parameter is required for the automatic daylight saving time adjustment.

0-74 DST/Summertime		
Option:	Function:	
		Select how to handle daylight saving time/summer time. For manual setting of DST/summer time,

0-74 DST/Summertime		
Option:	Function:	
		enter the start date and end date in <i>parameter 0-76 DST/Summertime Start</i> and <i>parameter 0-77 DST/Summertime End</i> .
[0] *	Off	
[2]	Manual	

0-76 DST/Summertime Start		
Range:	Function:	
Size related*	[0 - 0]	Sets the date and time when DST/summer time starts. The date is programmed in the format selected in <i>parameter 0-71 Date Format</i> .

0-77 DST/Summertime End		
Range:	Function:	
Size related*	[0 - 0]	Sets the date and time when DST/summer time ends. The date is programmed in the format selected in <i>parameter 0-71 Date Format</i> .

0-79 Clock Fault		
Option:	Function:	
		Enables or disables the clock warning when the clock has not been set, or has been reset due to a power-down and no back-up is installed. If VLT® Analog I/O Option MCB 109 is installed, [1] Enabled is default.
[0]	Disabled	
[1]	Enabled	

0-81 Working Days		
Array [7]		
Array with 7 elements [0]–[6] shown below the parameter number in the display. Press [OK] and step between elements with [▲] and [▼].		
Option:	Function:	
		Set for each weekday if it is a working day or a non-working day. First element of the array is Monday. The working days are used for timed actions.
[0]	No	
[1]	Yes	

0-82 Additional Working Days		
Array [5] Array with 5 elements [0]–[4] shown below the parameter number in the display. Press [OK] and step between elements with [▲] and [▼].		
Range:		Function:
Size related*	[0 - 0]	Defines dates for additional working days that would normally be non-working days according to <i>parameter 0-81 Working Days</i> .

0-83 Additional Non-Working Days		
Array [15] Array with 15 elements [0]–[14] shown below the parameter number in the display. Press [OK] and step between elements with [▲] and [▼].		
Range:		Function:
Size related*	[0 - 0]	Defines dates for additional working days that would normally be non-working days according to <i>parameter 0-81 Working Days</i> .

0-84 Time for Fieldbus		
Range:		Function:
0*	[0 - 4294967295]	Shows the time for fieldbus.

0-85 Summer Time Start for Fieldbus		
Range:		Function:
0*	[0 - 4294967295]	Shows the summer time start for fieldbus.

0-86 Summer Time End for Fieldbus		
Range:		Function:
0*	[0 - 4294967295]	Shows the summer time end for fieldbus.

0-89 Date and Time Readout		
Range:		Function:
0*	[0 - 25]	Shows the current date and time. The date and time is updated continuously. The clock does not begin counting until a setting different from default has been made in <i>parameter 0-70 Date and Time</i> .

3.3 Parameters 1-** Load and Motor

3.3.1 1-0* General Settings

Define whether the frequency converter operates in open loop or closed loop.

1-00 Configuration Mode	
Option:	Function:
	<p>NOTICE! This parameter cannot be adjusted while the motor is running.</p> <p>NOTICE! When set to [3] <i>Closed Loop</i>, the commands reversing and start reversing do not reverse the motor direction.</p>
[0]	<p>Open Loop</p> <p>Motor speed is determined by applying a speed reference or by setting the speed when in hand-on mode.</p> <p>Open loop is also used if the frequency converter is part of a closed-loop control system based on an external PID controller providing a speed reference signal as output.</p>
[3]	<p>Closed Loop</p> <p>Motor speed is determined by a reference from the built-in PID controller varying the motor speed as in a closed-loop control process (for example constant pressure or flow). Configure the PID controller in <i>parameter group 20-** Feedback</i> or via the <i>Function Set-ups</i> accessed by pressing [Quick Menu].</p>

1-01 Motor Control Principle	
Option:	Function:
	<p>NOTICE! This parameter cannot be adjusted while the motor is running.</p> <p>Select which motor control principle to employ.</p>
[0] *	<p>U/f</p> <p>Special motor mode for parallel connected motors in special motor applications. When U/f is selected, edit the characteristic of the control principle in <i>parameter 1-55 U/f Characteristic - U</i> and <i>parameter 1-56 U/f Characteristic - F</i>.</p>
[1]	<p>VVC+</p> <p>Voltage vector control principle suitable for most applications. The main benefit of VVC+ operation is that it uses a robust motor model.</p>

1-01 Motor Control Principle	
Option:	Function:
[2]	<p>Flux sensorless</p> <p>Flux vector control without encoder feedback, for simple installation and robustness against sudden load changes.</p>
[3]	<p>Flux w/ motor feedb</p> <p>High accuracy speed and torque control, suitable for the most demanding applications.</p>

1-03 Torque Characteristics	
Option:	Function:
[0]	<p>Constant torque</p> <p>For speed control of constant torque applications such as:</p> <ul style="list-style-type: none"> • Axial pumps. • Positive displacement pumps. • Blowers. <p>Provides a voltage, which is optimized for a constant torque load characteristic of the motor in the entire speed range.</p>
[1]	<p>Variable torque</p> <p>For speed control of centrifugal pumps and fans. Also to be used when controlling more than 1 motor from the same frequency converter (for example, multiple condenser fans or cooling tower fans). Provides a voltage, which is optimized for a squared torque load characteristic of the motor.</p>
[2]	<p>Auto Energy Optim. CT</p> <p>For optimum energy-efficient speed control of screw and scroll compressors. Provides a voltage, which is optimized for a constant torque load characteristic of the motor in the entire range down to 15 Hz. Furthermore, the AEO feature adapts the voltage exactly to the current load situation, reducing energy consumption and audible noise from the motor. To obtain optimal performance, set the motor power factor cos phi correctly. This value is set in <i>parameter 14-43 Motor Cosphi</i>. The parameter has a default value that is automatically adjusted when the motor data is programmed. These settings typically ensure optimum motor voltage, but if the motor power factor cos phi requires tuning, an AMA function can be carried out using <i>parameter 1-29 Automatic Motor Adaptation (AMA)</i>.</p>
[3] *	<p>Auto Energy Optim. VT</p> <p>For optimum energy-efficient speed control of centrifugal pumps and fans. Provides a voltage, which is optimized for a squared torque load characteristic of the motor. Furthermore, the AEO feature adapts the voltage exactly to the current load situation, reducing energy consumption and audible noise from the motor. To obtain optimal</p>

1-03 Torque Characteristics	
Option:	Function:
	performance, set the motor power factor correctly. This value is set in <i>parameter 14-43 Motor Cosphi</i> . The parameter has a default value that is automatically adjusted when the motor data is programmed. These settings typically ensure optimum motor voltage, but if the motor power factor cos phi requires tuning, an AMA function can be carried out using <i>parameter 1-29 Automatic Motor Adaptation (AMA)</i> . It is rarely necessary to adjust the motor power factor parameter manually.

NOTICE!

Parameter 1-03 Torque Characteristics has no effect when parameter 1-10 Motor Construction = [1] PM, non-salient SPM.

1-04 Overload Mode	
Select the torque level in overload mode.	
Option:	Function:
[0]	High torque Allows up to 160% overtorque for undersized motors.
[1] *	Normal torque Allows up to 110% overtorque.

1-06 Clockwise Direction	
Option:	Function:
	NOTICE! This parameter cannot be adjusted while the motor is running. This parameter defines the term clockwise corresponding to the LCP direction arrow. Used for easy change of direction of shaft rotation without swapping motor wires.
[0] *	Normal The motor shaft turns in clockwise direction when the frequency converter is connected U⇒U, V⇒V, and W⇒W to the motor.
[1]	Inverse Motor shaft turns in counterclockwise direction when the frequency converter is connected U⇒U, V⇒V, and W⇒W to the motor.

3.3.2 1-1* Motor Selection

NOTICE!

This parameter group cannot be adjusted while the motor is running.

The following parameters are active depending on the setting in *parameter 1-10 Motor Construction*.

<i>Parameter 1-10 Motor Construction</i>	[0] Asynchronous	[1] PM Motor non-salient	[2] PM Motor Salient IPM	[3] SynRM Motor
<i>Parameter 1-00 Configuration Mode</i>	x	x	x	x
<i>Parameter 1-03 Torque Characteristics</i>	x	-	-	-
<i>Parameter 1-06 Clockwise Direction</i>	x	x	x	x
<i>Parameter 1-14 Damping Gain</i>	-	x	x	x
<i>Parameter 1-15 Low Speed Filter Time Const.</i>	-	x	x	x
<i>Parameter 1-16 High Speed Filter Time Const.</i>	-	x	x	x
<i>Parameter 1-17 Voltage filter time const.</i>	-	x	x	x
<i>Parameter 1-20 Motor Power [kW]</i>	x	-	-	-
<i>Parameter 1-21 Motor Power [HP]</i>	x	-	-	-
<i>Parameter 1-22 Motor Voltage</i>	x	-	-	-
<i>Parameter 1-23 Motor Frequency</i>	x	-	-	-
<i>Parameter 1-24 Motor Current</i>	x	x	x	x
<i>Parameter 1-25 Motor Nominal Speed</i>	x	x	x	x
<i>Parameter 1-26 Motor Cont. Rated Torque</i>	-	x	x	x
<i>Parameter 1-28 Motor Rotation Check</i>	x	x	x	x
<i>Parameter 1-29 Automatic Motor Adaptation (AMA)</i>	x	x	x	x
<i>Parameter 1-30 Stator Resistance (Rs)</i>	x	x	x	x
<i>Parameter 1-31 Rotor Resistance (Rr)</i>	x	-	-	-
<i>Parameter 1-35 Main Reactance (Xh)</i>	x	-	-	-
<i>Parameter 1-37 d-axis Inductance (Ld)</i>	-	x	x	x
<i>Parameter 1-39 Motor Poles</i>	x	x	x	x

<i>Parameter 1-10 Motor Construction</i>	[0] Asynchronous	[1] PM Motor non-salient	[2] PM Motor Salient IPM	[3] SynRM Motor
Parameter 1-40 Back EMF at 1000 RPM	-	x	x	-
Parameter 1-44 d-axis Inductance Sat. (LdSat)	-	-	-	x
Parameter 1-45 q-axis Inductance Sat. (LqSat)	-	-	x	-
Parameter 1-46 Position Detection Gain	-	x	x	x
Parameter 1-47 Torque Calibration	-	x	x	x
Parameter 1-48 Inductance Sat. Point	-	-	-	x
Parameter 1-49 q-axis Inductance Sat. Point	-	-	x	-
Parameter 1-50 Motor Magnetisation at Zero Speed	x	-	-	-
Parameter 1-51 Min Speed Normal Magnetising [RPM]	x	-	-	-
Parameter 1-52 Min Speed Normal Magnetising [Hz]	x	-	-	-
Parameter 1-58 Flying Start Test Pulses Current	x	x	x	-
Parameter 1-59 Flying Start Test Pulses Frequency	x	x	x	-
Parameter 1-60 Low Speed Load Compensation	x	-	-	-
Parameter 1-61 High Speed Load Compensation	x	-	-	-
Parameter 1-62 Slip Compensation	x	-	-	-
Parameter 1-63 Slip Compensation Time Constant	x	-	-	-
Parameter 1-64 Resonance Damping	x	-	-	-
Parameter 1-65 Resonance Damping Time Constant	x	-	-	-
Parameter 1-66 Min. Current at Low Speed	-	x	x	x
Parameter 1-70 Start Mode	-	x	x	x

<i>Parameter 1-10 Motor Construction</i>	[0] Asynchronous	[1] PM Motor non-salient	[2] PM Motor Salient IPM	[3] SynRM Motor
Parameter 1-71 Start Delay	x	x	x	x
Parameter 1-72 Start Function	x	x	x	x
Parameter 1-73 Flying Start	x	x	x	x
Parameter 1-80 Function at Stop	x	x	x	x
Parameter 1-81 Min Speed for Function at Stop [RPM]	x	x	x	x
Parameter 1-82 Min Speed for Function at Stop [Hz]	x	x	x	x
Parameter 1-86 Trip Speed Low [RPM]	x	x	x	x
Parameter 1-87 Trip Speed Low [Hz]	x	x	x	x
Parameter 1-90 Motor Thermal Protection	x	x	x	x
Parameter 1-91 Motor External Fan	x	x	x	x
Parameter 1-93 Thermistor Source	x	x	x	x
Parameter 2-00 DC Hold/Preheat Current	x	-	x	x
Parameter 2-01 DC Brake Current	x	x	x	x
Parameter 2-02 DC Braking Time	x	-	x	x
Parameter 2-03 DC Brake Cut In Speed [RPM]	x	-	x	x
Parameter 2-04 DC Brake Cut-in Speed [Hz]	x	-	x	x
Parameter 2-06 Parking Current	-	x	x	x
Parameter 2-07 Parking Time	-	x	x	x
Parameter 2-10 Brake Function	x	x	x	x
Parameter 2-11 Brake Resistor (ohm)	x	x	x	x
Parameter 2-12 Brake Power Limit (kW)	x	x	x	x
Parameter 2-13 Brake Power Monitoring	x	x	x	x

Parameter 1-10 Motor Construction	[0] Asynchronous	[1] PM Motor non-salient	[2] PM Motor Salient IPM	[3] SynRM Motor
Parameter 2-15 Brake Check	x	x	x	x
Parameter 2-16 AC Brake Max. Current	x	-	-	-
Parameter 2-17 Over-voltage Control	x	x	x	x
Parameter 4-10 Motor Speed Direction	x	x	x	x
Parameter 4-11 Motor Speed Low Limit [RPM]	x	x	x	x
Parameter 4-12 Motor Speed Low Limit [Hz]	x	x	x	x
Parameter 4-13 Motor Speed High Limit [RPM]	x	x	x	x
Parameter 4-14 Motor Speed High Limit [Hz]	x	x	x	x
Parameter 4-16 Torque Limit Motor Mode	x	x	x	x
Parameter 4-17 Torque Limit Generator Mode	x	x	x	x
Parameter 4-18 Current Limit	x	x	x	x
Parameter 4-19 Max Output Frequency	x	x	x	x
Parameter 4-58 Missing Motor Phase Function	x	-	x	x
Parameter 14-40 VT Level	x	-	-	-
Parameter 14-41 AEO Minimum Magnetisation	x	-	-	-
Parameter 14-42 Minimum AEO Frequency	x	-	-	-
Parameter 14-43 Motor Cos-Phi	x	-	-	-

1-10 Motor Construction	
Select the motor construction type.	
Option:	Function:
[0] * Asynchron	For asynchronous motors.
[1] PM, non salient SPM	For permanent magnet (PM) motors. PM motors are divided into 2 groups, with either surface-mounted (non-salient) or interior (salient) magnets.
[2] PM, salient IPM	
[5] SynRM	

3.3.3 Asynchronous Motor Set-up

Enter the following motor data. Find the information on the motor nameplate.

1. Parameter 1-20 Motor Power [kW] or parameter 1-21 Motor Power [HP].
2. Parameter 1-22 Motor Voltage.
3. Parameter 1-23 Motor Frequency.
4. Parameter 1-24 Motor Current.
5. Parameter 1-25 Motor Nominal Speed.

For optimum performance in VVC⁺ mode, extra motor data is required to set up the following parameters. Find the data in the motor datasheet (this data is typically not available on the motor nameplate). Run a complete automatic motor adaptation (AMA) using parameter 1-29 Automatic Motor Adaptation (AMA) [1] Enable Complete AMA or enter the parameters manually. Parameter 1-36 Iron Loss Resistance (Rfe) is always entered manually.

1. Parameter 1-30 Stator Resistance (Rs).
2. Parameter 1-31 Rotor Resistance (Rr).
3. Parameter 1-33 Stator Leakage Reactance (X1).
4. Parameter 1-34 Rotor Leakage Reactance (X2).
5. Parameter 1-35 Main Reactance (Xh).
6. Parameter 1-36 Iron Loss Resistance (Rfe).

Application-specific adjustment when running VVC⁺
VVC⁺ is the most robust control mode. In most situations, it provides optimum performance without further adjustments. Run a complete AMA for best performance.

3.3.4 PM Motor Set-up

This section describes how to set up a PM motor.

Initial programming steps

To activate PM motor operation, select [1] PM, non-salient SPM or [2] PM, salient IPM in parameter 1-10 Motor Construction.

Programming motor data

After selecting a PM motor, the PM motor-related parameters in *parameter groups 1-2* Motor Data, 1-3* Adv. Motor Data, and 1-4* Adv. Motor Data II* are active.

The necessary data can be found on the motor nameplate and on the motor datasheet.

Program the following parameters in the order listed:

1. *Parameter 1-24 Motor Current.*
2. *Parameter 1-25 Motor Nominal Speed.*
3. *Parameter 1-26 Motor Cont. Rated Torque.*
4. *Parameter 1-39 Motor Poles.*

Run a complete AMA using *parameter 1-29 Automatic Motor Adaptation (AMA) [1] Enable Complete AMA.*

NOTICE!

When using AMA, make sure that the value of *parameter 1-40 Back EMF at 1000 RPM* is calculated using nominal speed.

If a complete AMA is not performed, configure the following parameters manually:

1. *Parameter 1-30 Stator Resistance (Rs)*
Enter the line-to-common stator winding resistance (R_s). If only line-line data is available, divide the line-line value by 2 to get the line-common value.
2. *Parameter 1-37 d-axis Inductance (Ld)*
Enter the line-to-common direct axis inductance of the PM motor.
If only line-line data is available, divide the line-line value by 2 to get the line-common value.
3. *Parameter 1-40 Back EMF at 1000 RPM.*
Enter the line-to-line back EMF of the PM Motor at 1000 RPM (RMS value). Back EMF is the voltage generated by a PM motor when no frequency converter is connected and the shaft is turned externally. It is normally specified for nominal motor speed or for 1000 RPM measured between 2 lines. If the value is not available for a motor speed of 1000 RPM, calculate the correct value as follows:
If back EMF is, for example, 320 V at 1800 RPM, it can be calculated at 1000 RPM as follows:
Back EMF = (Voltage/RPM)x1000 =
(320/1800)x1000 = 178.
4. For IPM motors: Configure the inductance values in the following parameters:

- *Parameter 1-38 q-axis Inductance (Lq).*
- *Parameter 1-44 d-axis Inductance Sat. (LdSat).*
- *Parameter 1-45 q-axis Inductance Sat. (LqSat).*
- *Parameter 1-49 q-axis Inductance Sat. Point.*

NOTICE!

IPM motors may be missing some inductance values on the nameplates or in the datasheets. Perform AMA to get the valid values.

Test motor operation

1. Start the motor at low speed (100–200 RPM). If the motor does not turn, check the installation, general programming, and motor data.
2. Check if the start function in *parameter 1-70 Start Mode* fits the application requirements.

Rotor detection

This function is the recommended selection for applications where the motor starts from standstill, for example pumps or conveyors. On some motors, a sound is heard when the frequency converter performs the rotor detection. This does not harm the motor.

Parking

This function is the recommended selection for applications where the motor is rotating at slow speed, for example windmilling in fan applications.
Parameter 2-06 Parking Current and *parameter 2-07 Parking Time* can be adjusted. Increase the factory setting of these parameters for applications with high inertia.

Application-specific adjustment when running VVC⁺

VVC⁺ is the most robust control mode. In most situations, it provides optimum performance without further adjustments. Run a complete AMA for best performance.

Start the motor at nominal speed. If the application does not run well, check the VVC⁺ PM settings. *Table 3.4* contains recommendations for various applications.

Application	Settings
Low-inertia applications $I_{Load}/I_{Motor} < 5$	Increase <i>parameter 1-17 Voltage filter time const.</i> by factor 5–10. Reduce <i>parameter 1-14 Damping Gain</i> . Reduce <i>parameter 1-66 Min. Current at Low Speed (<100%)</i> .
Low-inertia applications $50 > I_{Load}/I_{Motor} > 5$	Keep the default values.
High-inertia applications $I_{Load}/I_{Motor} > 50$	Increase <i>parameter 1-14 Damping Gain</i> , <i>parameter 1-15 Low Speed Filter Time Const.</i> , and <i>parameter 1-16 High Speed Filter Time Const.</i>
High load at low speed <30% (rated speed)	Increase <i>parameter 1-17 Voltage filter time const.</i> Increase <i>parameter 1-66 Min. Current at Low Speed</i> to adjust the starting torque. 100% current provides nominal torque as starting torque. Working at a current level higher than 100% for a prolonged time can cause the motor to overheat.

Table 3.4 Recommendations for Various Applications

If the motor starts oscillating at a certain speed, increase *parameter 1-14 Damping Gain*. Increase the value in small steps. Depending on the motor, this parameter can be set to 10–100% higher than the default value.

3.3.5 SynRM Motor Set-up

This section describes how to set up a synchronous reluctance motor.

Initial programming steps

To activate SynRM motor operation, select option [5] *SynRM* in *parameter 1-10 Motor Construction*.

Programming motor data

After selecting option [5] *SynRM*, the SynRM motor-related parameters in *parameter groups 1-2* Motor Data*, *1-3* Adv. Motor Data*, and *1-4* Adv. Motor Data II* are active. The necessary data can be found on the motor nameplate and on the motor datasheet.

Program the following parameters in the order listed:

1. *Parameter 1-24 Motor Current*.
2. *Parameter 1-25 Motor Nominal Speed*.
3. *Parameter 1-26 Motor Cont. Rated Torque*.
4. *Parameter 1-39 Motor Poles*.

Run a complete AMA using *parameter 1-29 Automatic Motor Adaptation (AMA)* [1] *Enable Complete AMA*.

If a complete AMA is not performed, configure the following parameters manually:

1. *Parameter 1-30 Stator Resistance (Rs)*
Enter the line-to-common stator winding resistance (R_s). If only line-line data is available, divide the line-line value by 2 to get the line-common value.
2. *Parameter 1-37 d-axis Inductance (Ld)*
Enter the line-to-common direct axis inductance of the motor.
If only line-line data is available, divide the line-line value by 2 to get the line-common value.
3. *Parameter 1-38 q-axis Inductance (Lq)*
Enter the line-to-common quadrature axis inductance of the motor.
If only line-line data is available, divide the line-line value by 2 to get the line-common value.
4. *Parameter 1-44 d-axis Inductance Sat. (LdSat)*
Enter the line-to-common saturated value of the d-axis inductance. This is the value at a current higher than the nominal current where the inductance is fully saturated.
5. *Parameter 1-48 Inductance Sat. Point*
Enter the percentage of nominal current where the d-axis inductance is half-saturated, that is has the average value of the non-saturated and saturated values.

NOTICE!

Motors may be missing some inductance values on the nameplates or in the datasheets. Perform AMA to get the valid values.

Test motor operation

1. Start the motor at low speed (100–200 RPM). If the motor does not turn, check the installation, general programming, and motor data.
2. Check if the start function in *parameter 1-70 Start Mode* fits the application requirements.

Rotor detection

This function is the recommended selection for applications where the motor starts from standstill, for example pumps or conveyors. On some motors, a sound is heard when the frequency converter performs the rotor detection. This does not harm the motor.

Parking

This function is the recommended selection for applications where the motor is rotating at slow speed, for example windmilling in fan applications. *Parameter 2-06 Parking Current* and *parameter 2-07 Parking Time* can be adjusted. Increase the factory setting of these parameters for applications with high inertia.

Application-specific adjustment when running VVC+

VVC+ is the most robust control mode. In most situations, it provides optimum performance without further adjustments. Run a complete AMA for best performance.

Start the motor at nominal speed. If the application does not run well, check the VVC+ SynRM settings. Table 3.5 contains recommendations for various applications.

Application	Settings
Low-inertia applications $I_{Load}/I_{Motor} < 5$	Increase <i>parameter 1-17 Voltage filter time const.</i> by factor 5–10. Reduce <i>parameter 1-14 Damping Gain</i> . Reduce <i>parameter 1-66 Min. Current at Low Speed (<100%)</i> .
Low-inertia applications $50 > I_{Load}/I_{Motor} > 5$	Keep the default values.
High-inertia applications $I_{Load}/I_{Motor} > 50$	Increase <i>parameter 1-14 Damping Gain</i> , <i>parameter 1-15 Low Speed Filter Time Const.</i> , and <i>parameter 1-16 High Speed Filter Time Const.</i>
High load at low speed <30% (rated speed)	Increase <i>parameter 1-17 Voltage filter time const.</i> Increase <i>parameter 1-66 Min. Current at Low Speed</i> to adjust the starting torque. 100% current provides nominal torque as starting torque. Working at a current level higher than 100% for a prolonged time can cause the motor to overheat.

Table 3.5 Recommendations for Various Applications

If the motor starts oscillating at a certain speed, increase *parameter 1-14 Damping Gain*. Increase the value in small steps. Depending on the motor, this parameter can be set to 10–100% higher than the default value.

3.3.6 1-1* VVC+ PM/SynRM

The default control parameters for VVC+ PMSM control core are optimized for applications and inertia load in range of $50 > J_l/J_m > 5$. J_l is load inertia from the application and J_m is machine inertia.

For low-inertia applications ($J_l/J_m < 5$), increase *parameter 1-17 Voltage filter time const.* with a factor of 5–10 and sometimes *parameter 1-14 Damping Gain* to improve performance and stability.

For high-inertia applications ($J_l/J_m > 50$) increase *parameter 1-15 Low Speed Filter Time Const.*, *parameter 1-16 High Speed Filter Time Const.*, and *parameter 1-14 Damping Gain* to improve performance and stability.

For high load at low speed (<30% of rated speed), increase *parameter 1-17 Voltage filter time const.* due to non-linearity in the inverter at low speed.

1-11 Motor Model

Option:	Function:
	Automatically sets the factory values for the selected motor. If the default value <i>Std. Asynchron</i> is used, determine settings manually according to the selection <i>parameter 1-10 Motor Construction</i> .
[1] Std. Asynchron	Default motor model when [0] <i>Asynchron</i> is selected in <i>parameter 1-10 Motor Construction</i> .
[2] Std. PM, non salient	Selectable when [1] <i>PM, non-salient SPM</i> is selected in <i>parameter 1-10 Motor Construction</i> .
[10] Danfoss OGD LA10	Selectable when [1] <i>PM, non-salient SPM</i> is selected in <i>parameter 1-10 Motor Construction</i> . Only available for T4, T5 in 1.5–3 kW. Settings are loaded automatically for this specific motor.
[11] Danfoss OGD V210	Selectable when [1] <i>PM, non-salient SPM</i> is selected in <i>parameter 1-10 Motor Construction</i> . Only available for T4, T5 in 0.75–3 kW. Settings are loaded automatically for this specific motor.

1-14 Damping Gain

Range:	Function:
Size related* [0 - 250 %]	The parameter stabilizes the PM motor so it runs smoothly and with stability. The value of damping gain controls the dynamic performance of the PM motor. Low damping gain results in high dynamic performance and a high value results in a low dynamic performance. If the damping gain is too high or low, the control becomes unstable. The resulting dynamic performance is related to the machine data and load type.

1-15 Low Speed Filter Time Const.

Range:	Function:
Size related* [0.01 - 20 s]	High-pass filter damping time constant determines the response time to load steps. Obtain quick control through a short damping time constant. However, if this value is too low, the control becomes unstable. This time constant is used below 10% rated speed.

1-16 High Speed Filter Time Const.

Range:	Function:
Size related* [0.01 - 20 s]	High-pass filter damping time constant determines the response time to load

1-16 High Speed Filter Time Const.		
Range:		Function:
		steps. Obtain quick control through a short damping time constant. However, if this value is too low, the control becomes unstable. This time constant is used above 10% rated speed.

1-17 Voltage filter time const.		
Range:		Function:
Size related*	[0.001 - 2 s]	Supply voltage filter time constant is used for reducing the influence of high frequency ripples and system resonances in the calculation of machine supply voltage. Without this filter, the ripples in the currents can distort the calculated voltage and affect the stability of the system.

3.3.7 1-2* Motor Data

This parameter group contains input data from the nameplate on the connected motor.

NOTICE!

Changing the value of these parameters affects the setting of other parameters.

NOTICE!

The following parameters have no effect when *parameter 1-10 Motor Construction* is set to [1] PM, non-salient SPM, [2] PM, salient IPM, [5] Sync. Reluctance:

- *Parameter 1-20 Motor Power [kW].*
- *Parameter 1-21 Motor Power [HP].*
- *Parameter 1-22 Motor Voltage.*
- *Parameter 1-23 Motor Frequency.*

1-20 Motor Power [kW]		
Range:		Function:
Size related*	[0.09 - 2000.00 kW]	<p>NOTICE!</p> <p>This parameter cannot be adjusted while the motor is running.</p> <p>Enter the nominal motor power in kW according to the motor nameplate data. The default value corresponds to the nominal rated output of the unit.</p> <p>Depending on the selections made in <i>parameter 0-03 Regional Settings</i>, either</p>

1-20 Motor Power [kW]		
Range:		Function:
		<i>parameter 1-20 Motor Power [kW]</i> or <i>parameter 1-21 Motor Power [HP]</i> is made invisible.

1-21 Motor Power [HP]		
Range:		Function:
Size related*	[0.09 - 500.00 hp]	<p>NOTICE!</p> <p>This parameter cannot be adjusted while the motor is running.</p> <p>Enter the nominal motor power in hp according to the motor nameplate data. The default value corresponds to the nominal rated output of the unit. Depending on the selections made in <i>parameter 0-03 Regional Settings</i>, either <i>parameter 1-20 Motor Power [kW]</i> or <i>parameter 1-21 Motor Power [HP]</i> is made invisible.</p>

1-22 Motor Voltage		
Range:		Function:
500. V*	[10. - 1000. V]	<p>NOTICE!</p> <p>This parameter cannot be adjusted while the motor is running.</p> <p>Enter the nominal motor voltage according to the motor nameplate data. The default value corresponds to the nominal rated output of the unit.</p>

1-23 Motor Frequency		
Range:		Function:
Size related*	[20 - 1000 Hz]	<p>NOTICE!</p> <p>This parameter cannot be adjusted while the motor is running.</p> <p>Select the motor frequency value from the motor nameplate data. For 87 Hz operation with 230/400 V motors, set the nameplate data for 230 V/50 Hz. Adapt <i>parameter 4-13 Motor Speed High Limit [RPM]</i> and <i>parameter 3-03 Maximum Reference</i> to the 87 Hz application.</p>

1-24 Motor Current		
Range:		Function:
Size related*	[0.10 - 10000.00 A]	<p>NOTICE!</p> <p>This parameter cannot be adjusted while the motor is running.</p> <p>Enter the nominal motor current value from the motor nameplate data. The data is used for calculating motor torque, motor thermal protection, and so on.</p>

1-25 Motor Nominal Speed		
Range:		Function:
Size related*	[100 - 60000 RPM]	<p>NOTICE!</p> <p>This parameter cannot be adjusted while the motor is running.</p> <p>Enter the nominal motor speed value from the motor nameplate data. The data is used for calculating automatic motor compensations.</p>

1-26 Motor Cont. Rated Torque		
Range:		Function:
Size related*	[1 - 10000.0 Nm]	<p>Enter the value from the motor nameplate data. The default value corresponds to the nominal rated output. This parameter is available when <i>parameter 1-10 Motor Construction</i> is set to [1] PM, non-salient SPM, that is the parameter is valid for PM and non-salient SPM motors only.</p>

1-28 Motor Rotation Check		
Option:	Function:	
	<p>⚠ WARNING</p> <p>HIGH VOLTAGE</p> <p>Frequency converters contain high voltage when connected to AC mains input, DC supply, or load sharing.</p> <ul style="list-style-type: none"> Remove mains power before disconnecting motor phase cables. 	

1-28 Motor Rotation Check		
Option:	Function:	
	<p>NOTICE!</p> <p>Once the motor rotation check is enabled, the display shows: <i>Note! Motor may run in wrong direction.</i> Pressing [OK], [Back], or [Cancel] dismisses the message and shows a new message: <i>Press [Hand On] to start the motor. Press [Cancel] to abort.</i> Pressing [Hand On] starts the motor at 5 Hz in forward direction and the display shows: <i>Motor is running.</i> Check if motor rotation direction is correct. Press [Off] to stop the motor. Pressing [Off] stops the motor and resets <i>parameter 1-28 Motor Rotation Check</i>. If motor rotation direction is incorrect, interchange 2 motor phase cables.</p> <p>Following installation and connection of the motor, this function allows the correct motor rotation direction to be verified. Enabling this function overrides any bus commands or digital inputs, except external interlock and Safe Torque Off (STO) (if included).</p>	
[0]	Off	Motor rotation check is not active.
*		
[1]	Enabled	Motor rotation check is enabled.

1-29 Automatic Motor Adaptation (AMA)		
Option:	Function:	
	<p>The AMA function optimizes dynamic motor performance by automatically optimizing the advanced motor <i>parameter 1-30 Stator Resistance (Rs)</i> to <i>parameter 1-35 Main Reactance (Xh)</i> while the motor is stationary.</p>	
[0]	Off	No function.
*		
[1]	Enable Complete AMA	Performs AMA of the stator resistance R_s , the rotor resistance R_r , the stator leakage reactance X_1 , the rotor leakage reactance X_2 , and the main reactance X_h .
[2]	Enable Reduced AMA	Performs a reduced AMA of the stator resistance R_s in the system only. Select this option if an LC filter is used between the frequency converter and the motor.
[3]	Enable Complete AMA II	Performs enhanced functionality AMA II of the stator resistance R_s , the rotor resistance R_r , the stator leakage reactance X_1 , the rotor leakage reactance X_2 , and the main reactance X_h . For

1-30 Stator Resistance (Rs)		
Range:		Function:
Size related*	[0.0140 - 140.0000 Ohm]	<p>NOTICE!</p> <p>This parameter cannot be adjusted while the motor is running.</p> <p>For PM motors, see the description in parameter 1-37 <i>d-axis Inductance (Ld)</i>.</p> <p>Set the stator resistance value. Enter the value from a motor datasheet or perform an AMA on a cold motor.</p>

1-31 Rotor Resistance (Rr)		
Range:		Function:
1.0000 Ohm*	[0.0100 - 100.0000 Ohm]	<p>NOTICE!</p> <p>Parameter 1-31 Rotor Resistance (Rr) has no effect when parameter 1-10 Motor Construction is set to [1] PM, non-salient SPM, [5] Sync. Reluctance.</p> <p>Set the rotor resistance value R_r to improve shaft performance using 1 of these methods:</p> <ul style="list-style-type: none"> Run an AMA on a cold motor. The frequency converter measures the value from the motor. All compensations are reset to 100%. Enter the R_r value manually. Obtain the value from the motor supplier. Use the R_r default setting. The frequency converter establishes the setting based on the motor nameplate data.

1-33 Stator Leakage Reactance (X1)		
Range:		Function:
4.0000 Ohm*	[0.0400 - 400.0000 Ohm]	<p>NOTICE!</p> <p>This parameter is only relevant for asynchronous motors.</p> <p>Set the stator leakage reactance of the motor using 1 of these methods:</p> <ul style="list-style-type: none"> Run an AMA on a cold motor. The frequency converter

1-33 Stator Leakage Reactance (X1)		
Range:		Function:
		<p>measures the value from the motor.</p> <ul style="list-style-type: none"> Enter the X₁ value manually. Obtain the value from the motor supplier. Use the X₁ default setting. The frequency converter establishes the setting based on the motor nameplate data. <p>See Figure 3.4.</p> <p>NOTICE!</p> <p>The parameter value is updated after each torque calibration if option [3] <i>1st start with store</i> or option [4] <i>Every start with store</i> is selected in parameter 1-47 Torque Calibration.</p>

1-34 Rotor Leakage Reactance (X2)		
Range:		Function:
4.0000 Ohm*	[0.0400 - 400.0000 Ohm]	<p>NOTICE!</p> <p>This parameter is only relevant for asynchronous motors.</p> <p>Set the rotor leakage reactance of the motor using 1 of these methods:</p> <ul style="list-style-type: none"> Run an AMA on a cold motor. The frequency converter measures the value from the motor. Enter the X₂ value manually. Obtain the value from the motor supplier. Use the X₂ default setting. The frequency converter establishes the setting based on the motor nameplate data. <p>See Figure 3.4.</p> <p>NOTICE!</p> <p>The parameter value is updated after each torque calibration if option [3] <i>1st start with store</i> or option [4] <i>Every start with store</i> is selected in parameter 1-47 Torque Calibration.</p>

1-35 Main Reactance (Xh)		
Range:		Function:
Size related*	[1.0000 - 10000.0000 Ohm]	<p>NOTICE! Parameter 1-35 Main Reactance (Xh) has no effect when parameter 1-10 Motor Construction=[1] PM, non-salient SPM.</p> <p>NOTICE! This parameter cannot be adjusted while the motor is running.</p> <p>Set the main reactance of the motor using 1 of these methods:</p> <ul style="list-style-type: none"> Run an AMA on a cold motor. The frequency converter measures the value from the motor. Enter the X_h value manually. Obtain the value from the motor supplier. Use the X_h default setting. The frequency converter establishes the setting from the motor nameplate data.

1-36 Iron Loss Resistance (Rfe)		
Range:		Function:
Size related*	[0 - 10000.000 Ohm]	<p>NOTICE! This parameter cannot be adjusted while the motor is running.</p> <p>Enter the equivalent iron loss resistance (R_{Fe}) value to compensate for iron losses in the motor. The R_{Fe} value cannot be found by performing an AMA. The R_{Fe} value is especially important in torque control applications. If R_{Fe} is unknown, leave parameter 1-36 Iron Loss Resistance (Rfe) on default setting.</p>

1-37 d-axis Inductance (Ld)		
Range:		Function:
Size related*	[0.000 - 1000.000 mH]	<p>NOTICE! This parameter is only active when parameter 1-10 Motor Construction is set to [1] PM, non-salient SPM.</p> <p>Enter the value of the d-axis inductance. Obtain the value from the PM motor datasheet.</p>

For asynchronous motor, stator resistance, and d-axis inductance values are normally described in technical specifications as between line and common (startpoint). For PM motors, they are typically described in technical specifications as between line-line. PM motors are typically built for star connection.

Parameter 1-30 Stator Resistance (Rs) (line to common).	This parameter gives stator winding resistance (R _s) similar to asynchronous motor stator resistance. The stator resistance is defined for line-to-common measurement. For line-line data, where stator resistance is measured between any 2 lines, divide by 2.
Parameter 1-37 d-axis Inductance (Ld) (line to common).	This parameter gives direct axis inductance of the PM motor. The d-axis inductance is defined for phase-to-common measurement. For line-line data, where stator resistance is measured between any 2 lines, divide by 2.
Parameter 1-40 Back EMF at 1000 RPM (RMS (line to line value)).	This parameter gives back EMF across stator terminal of PM motor at 1000 RPM mechanical speed specifically. It is defined between line-to-line and expressed in RMS value.

Table 3.6 Parameters Related to PM Motors

NOTICE!

Motor manufacturers provide values for stator resistance (parameter 1-30 Stator Resistance (R_s)) and d-axis inductance (parameter 1-37 d-axis Inductance (L_d)) in technical specifications as between line and common (startpoint) or line between line. There is no general standard. The different set-ups of stator winding resistance and induction are shown in Figure 3.6. Danfoss frequency converters always require the line-to-common value. The back EMF of a PM motor is defined as induced EMF developed across any of 2 phases of stator winding of a free-running motor. Danfoss frequency converters always require the line-to-line RMS value measured at 1000 RPM, mechanical speed of rotation. This is shown in Figure 3.7.

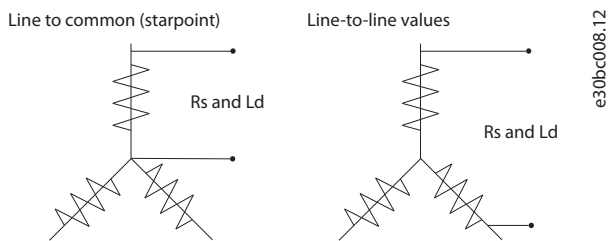

Figure 3.6 Stator Winding Set-ups

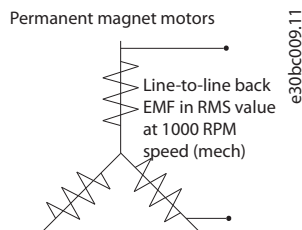

Figure 3.7 Machine Parameter Definitions of Back EMF of PM Motors

1-38 q-axis Inductance (L_q)		
Range:		Function:
Size related*	[0.000 - 1000 mH]	NOTICE! This parameter cannot be adjusted while the motor is running. Set the value of the q-axis inductance. See the motor datasheet.

1-39 Motor Poles														
Range:		Function:												
Size related*	[2 - 132]	NOTICE! This parameter cannot be adjusted while the motor is running. Enter the number of motor poles.												
		<table border="1"> <thead> <tr> <th>Poles</th> <th>~n_n@ 50 Hz</th> <th>~n_n@ 60 Hz</th> </tr> </thead> <tbody> <tr> <td>2</td> <td>2700–2880</td> <td>3250–3460</td> </tr> <tr> <td>4</td> <td>1350–1450</td> <td>1625–1730</td> </tr> <tr> <td>6</td> <td>700–960</td> <td>840–1153</td> </tr> </tbody> </table>	Poles	~ n_n @ 50 Hz	~ n_n @ 60 Hz	2	2700–2880	3250–3460	4	1350–1450	1625–1730	6	700–960	840–1153
Poles	~ n_n @ 50 Hz	~ n_n @ 60 Hz												
2	2700–2880	3250–3460												
4	1350–1450	1625–1730												
6	700–960	840–1153												
<p>Table 3.7 Pole Counts and Related Frequencies</p> <p>Table 3.7 shows the pole numbers for normal speed ranges of various motor types. Define motors designed for other frequencies separately. The motor pole value is always an even number, because it refers to the total pole numbers, not pairs of poles. The frequency converter creates the initial setting of parameter 1-39 Motor Poles based on parameter 1-23 Motor Frequency and parameter 1-25 Motor Nominal Speed.</p>														

1-40 Back EMF at 1000 RPM		
Range:		Function:
Size related*	[10 - 9000 V]	Set the nominal back EMF for the motor when running at 1000 RPM. This parameter is only active when parameter 1-10 Motor Construction is set to [1] PM, non-salient SPM.

1-44 d-axis Inductance Sat. (L_d Sat)		
Range:		Function:
Size related*	[0 - 1000 mH]	Enter the inductance saturation of L_d . Ideally, this parameter has the same value as parameter 1-37 d-axis Inductance (L_d). If the motor supplier provides an induction curve, enter the induction value at 200% of the nominal value.

1-45 q-axis Inductance Sat. (L_q Sat)		
Range:		Function:
Size related*	[0 - 1000 mH]	This parameter corresponds to the inductance saturation of L_q . Ideally, this parameter has the same value as parameter 1-38 q-axis Inductance (L_q). If the motor supplier provides an induction

1-45 q-axis Inductance Sat. (LqSat)	
Range:	Function:
	curve, enter the induction value at 200% of the nominal value.

1-47 Torque Calibration	
Option:	Function:
[0] Off	Use this parameter to optimize the torque estimate in the full speed range. The estimated torque is based on the shaft power, $P_{\text{shaft}} = P_m - R_s \times I^2$. Make sure that the R_s value is correct. The R_s value in this formula is equal to the power loss in the motor, the cable, and the frequency converter. When this parameter is active, the frequency converter calculates the R_s value during power-up, ensuring the optimal torque estimate and optimal performance. Use this feature in cases when it is not possible to adjust <i>parameter 1-30 Stator Resistance (Rs)</i> on each frequency converter to compensate for the cable length, frequency converter losses, and the temperature deviation on the motor.
[1] 1st start after pwr-up	Calibrates at the first start-up after power-up and keeps this value until reset by a power cycle.
[2] Every start	Calibrates at every start-up, compensating for a possible change in motor temperature since last start-up. The value is reset after a power cycle.
[3] 1st start with store	The frequency converter calibrates the torque at the first start-up after power-up. This option is used to update motor parameters: <ul style="list-style-type: none"> • <i>Parameter 1-30 Stator Resistance (Rs)</i>. • <i>Parameter 1-33 Stator Leakage Reactance (X1)</i>. • <i>Parameter 1-34 Rotor Leakage Reactance (X2)</i>. • <i>Parameter 1-37 d-axis Inductance (Ld)</i>.
[4] Every start with store	The frequency converter calibrates the torque at every start-up, compensating for a possible change in motor temperature since last start-up. This option is used to update motor parameters: <ul style="list-style-type: none"> • <i>Parameter 1-30 Stator Resistance (Rs)</i>. • <i>Parameter 1-33 Stator Leakage Reactance (X1)</i>. • <i>Parameter 1-34 Rotor Leakage Reactance (X2)</i>.

1-47 Torque Calibration	
Option:	Function:
	<ul style="list-style-type: none"> • <i>Parameter 1-37 d-axis Inductance (Ld)</i>.

1-48 Inductance Sat. Point	
Range:	Function:
Size related* [1 - 500 %]	Enter the induction saturation point.

1-49 q-axis Inductance Sat. Point	
Range:	Function:
Size related* [0 - 200 %]	<p>NOTICE!</p> <p>Run an AMA to set the value of this parameter. Edit the value manually only when the application requires a value other than determined by AMA.</p> <p>Enter the q-Axis inductance saturation point. The frequency converter uses this value to optimize the performance of IPM motors.</p> <p>Select the value that matches the point where the inductance equals the average value of <i>parameter 1-38 q-axis Inductance (Lq)</i> and <i>parameter 1-45 q-axis Inductance Sat. (LqSat)</i>, as percentage of nominal current.</p>

3.3.9 1-5* Load Indep. Setting

3

1-50 Motor Magnetisation at Zero Speed		
Range:	Function:	
100 %*	[0 - 300 %]	<p>NOTICE!</p> <p>Parameter 1-50 Motor Magnetisation at Zero Speed has no effect when parameter 1-10 Motor Construction = [1] PM, non-salient SPM.</p> <p>Use this parameter along with parameter 1-51 Min Speed Normal Magnetising [RPM] to obtain a different thermal load on the motor when running at low speed. Enter a value which is a percentage of the rated magnetizing current. If the setting is too low, the torque on the motor shaft may be reduced.</p> <p>Figure 3.8 Magnetizing Current</p>

1-51 Min Speed Normal Magnetising [RPM]		
Range:	Function:	
Size related*	[10 - 300 RPM]	<p>NOTICE!</p> <p>Parameter 1-51 Min Speed Normal Magnetising [RPM] has no effect when parameter 1-10 Motor Construction = [1] PM, non-salient SPM.</p> <p>Set the required speed for normal magnetizing current. If the speed is set lower than the motor slip speed, parameter 1-50 Motor Magnetisation at Zero Speed and parameter 1-51 Min Speed Normal Magnetising [RPM] are of no significance. Use this parameter along with parameter 1-50 Motor Magnetisation at Zero Speed. See Table 3.7.</p>

1-52 Min Speed Normal Magnetising [Hz]		
Range:	Function:	
Size related*	[0.3 - 10.0 Hz]	<p>NOTICE!</p> <p>Parameter 1-52 Min Speed Normal Magnetising [Hz] has no effect when parameter 1-10 Motor Construction = [1] PM, non-salient SPM.</p> <p>Set the required frequency for normal magnetizing current. If the frequency is set lower than the motor slip frequency, parameter 1-50 Motor Magnetisation at Zero Speed and parameter 1-51 Min Speed Normal Magnetising [RPM] are inactive. Use this parameter along with parameter 1-50 Motor Magnetisation at Zero Speed. See Table 3.7.</p>

1-55 U/f Characteristic - U		
Array [6]		
Range:	Function:	
0 V*	[0.0 - 1000.0 V]	<p>Enter the voltage at each frequency point to form a U/f characteristic manually matching the motor. The frequency points are defined in parameter 1-56 U/f Characteristic - F. This parameter is an array parameter [0-5] and is only accessible when parameter 1-01 Motor Control Principle is set to [0] U/f.</p>

1-56 U/f Characteristic - F		
Array [6]		
Range:	Function:	
0 Hz*	[0 - 1000.0 Hz]	<p>Enter the frequency points to form a U/f characteristic manually matching the motor. The voltage at each point is defined in parameter 1-55 U/f Characteristic - U. This parameter is an array parameter [0-5] and is only accessible when parameter 1-01 Motor Control Principle is set to [0] U/f.</p>

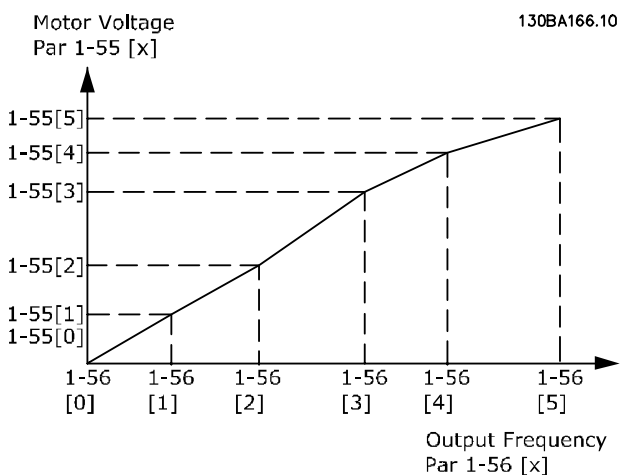

Figure 3.9 U/f Characteristic

1-58 Flying Start Test Pulses Current		
Range:	Function:	
Size related*	[0 - 200 %]	Set the magnitude of the magnetizing current for the pulses used to detect the motor direction. The value range and function depend on <i>parameter 1-10 Motor Construction</i> : [0] Asynchronous: [0–200%] Reducing this value reduces the generated torque. 100% means full nominal motor current. In this case, the default value is 30%. [1] PM non-salient: [0–40%] A general setting of 20% is recommended for PM motors. Higher values can give increased performance. However, on motors with back EMF higher than 300 VLL (rms) at nominal speed and high winding inductance (more than 10 mH), a lower value is recommended to avoid wrong speed estimation. The parameter is active when <i>parameter 1-73 Flying Start</i> is enabled.

1-59 Flying Start Test Pulses Frequency		
Range:	Function:	
Size related*	[0 - 500 %]	NOTICE! See description of <i>parameter 1-70 Start Mode</i> for an overview of the relation between the PM Flying Start parameters. The value range and function depend on <i>parameter 1-10 Motor Construction</i> : [0] Asynchronous: [0–500%] Control the percentage of the frequency for the pulses used to detect the motor direction. Increasing this value reduces the generated

1-59 Flying Start Test Pulses Frequency		
Range:	Function:	
		torque. In this mode, 100% means 2 times the slip frequency. [1] PM non-salient: [0–10%] This parameter defines the motor speed (in % of nominal motor speed) below which the parking function (see <i>parameter 2-06 Parking Current</i> and <i>parameter 2-07 Parking Time</i>) becomes active. This parameter is only active when <i>parameter 1-70 Start Mode</i> is set to [1] <i>Parking</i> and only after starting the motor.

3.3.10 1-6* Load Depend. Setting

1-60 Low Speed Load Compensation										
Range:	Function:									
100 %*	[0 - 300 %]	NOTICE! <i>Parameter 1-60 Low Speed Load Compensation</i> has no effect when <i>parameter 1-10 Motor Construction</i> = [1] <i>PM, non-salient SPM</i> . Enter the % value to compensate voltage in relation to load when the motor is running at low speed and obtain the optimum U/f characteristic. The motor size determines the frequency range within which this parameter is active.								
<table border="1"> <thead> <tr> <th>Motor size [kW]</th> <th>Changeover [Hz]</th> </tr> </thead> <tbody> <tr> <td>0.25–7.5</td> <td><10</td> </tr> <tr> <td>11–45</td> <td><5</td> </tr> <tr> <td>55–550</td> <td><3–4</td> </tr> </tbody> </table>			Motor size [kW]	Changeover [Hz]	0.25–7.5	<10	11–45	<5	55–550	<3–4
Motor size [kW]	Changeover [Hz]									
0.25–7.5	<10									
11–45	<5									
55–550	<3–4									
Table 3.8 Changeover Frequency										

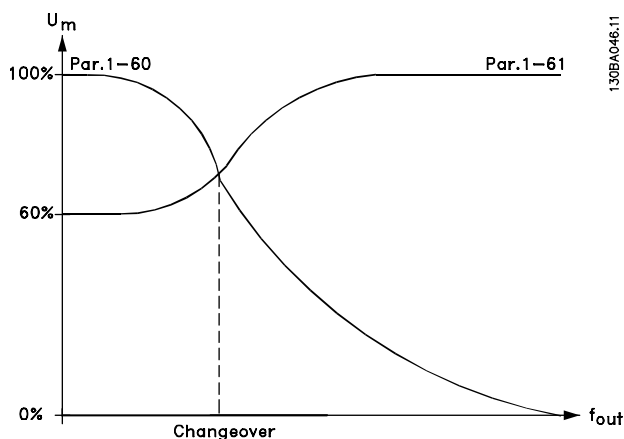

Figure 3.10 Low Speed Load Compensation

1-61 High Speed Load Compensation									
Range:	Function:								
100 %* [0 - 300 %]	<p>NOTICE! Parameter 1-61 High Speed Load Compensation has no effect when parameter 1-10 Motor Construction = [1] PM, non-salient SPM.</p> <p>Enter the % value to compensate voltage in relation to load when the motor is running at high speed and obtain the optimum U/f characteristic. The motor size determines the frequency range within which this parameter is active.</p> <table border="1"> <thead> <tr> <th>Motor size [kW]</th> <th>Changeover [Hz]</th> </tr> </thead> <tbody> <tr> <td>0.25–7.5</td> <td>>10</td> </tr> <tr> <td>11–45</td> <td><5</td> </tr> <tr> <td>55–550</td> <td><3–4</td> </tr> </tbody> </table> <p>Table 3.9 Changeover Frequency</p>	Motor size [kW]	Changeover [Hz]	0.25–7.5	>10	11–45	<5	55–550	<3–4
Motor size [kW]	Changeover [Hz]								
0.25–7.5	>10								
11–45	<5								
55–550	<3–4								

1-62 Slip Compensation	
Range:	Function:
0 %* [-500 - 500 %]	<p>NOTICE! Parameter 1-62 Slip Compensation has no effect when parameter 1-10 Motor Construction = [1] PM, non-salient SPM.</p> <p>To compensate for tolerances in the value of $n_{M,N}$, enter the % value for slip compensation. Slip compensation is calculated automatically, that is based on the nominal motor speed $n_{M,N}$.</p>

1-63 Slip Compensation Time Constant	
Range:	Function:
Size related* [0.05 - 5 s]	<p>NOTICE! Parameter 1-63 Slip Compensation Time Constant has no effect when parameter 1-10 Motor Construction = [1] PM, non-salient SPM.</p> <p>Enter the slip compensation reaction speed. A high value results in slow reaction, and a low value results in quick reaction. If low-frequency resonance problems occur, use a longer time setting.</p>

1-64 Resonance Damping	
Range:	Function:
Size related* [0 - 500 %]	<p>NOTICE! Parameter 1-64 Resonance Damping has no effect when parameter 1-10 Motor Construction = [1] PM, non-salient SPM.</p> <p>Enter the resonance damping value. Set parameter 1-64 Resonance Damping and parameter 1-65 Resonance Damping Time Constant to help eliminate high frequency resonance problems. To reduce resonance oscillation, increase the value of parameter 1-64 Resonance Damping.</p>

1-65 Resonance Damping Time Constant	
Range:	Function:
5 ms* [5 - 50 ms]	<p>NOTICE! Parameter 1-65 Resonance Damping Time Constant has no effect when parameter 1-10 Motor Construction = [1] PM, non-salient SPM.</p> <p>Set parameter 1-64 Resonance Damping and parameter 1-65 Resonance Damping Time Constant to help eliminate high frequency resonance problems. Enter the time constant that provides the best dampening.</p>

1-66 Min. Current at Low Speed	
Range:	Function:
Size related* [1 - 200 %]	<p>NOTICE! Parameter 1-66 Min. Current at Low Speed has no effect if parameter 1-10 Motor Construction = [0] Asynchron.</p> <p>Enter the minimum motor current at low speed. Increasing this current improves developed motor torque at low speed. Low speed is here defined as speeds below 6% of the nominal motor speed (parameter 1-25 Motor Nominal Speed) in VVC+ PM Control.</p>

3.3.11 1-7* Start Adjustments

1-70 Start Mode		
Option:	Function:	
[0]	Rotor Detection	Suitable for all applications where the motor is known to be standing still when starting (for example conveyors, pumps, and non-wind milling fans).
[1]	Parking	If the motor turns at a low speed (that is lower than 2–5% of the nominal speed), for example due to fans with windmilling, select [1] Parking and adjust <i>parameter 2-06 Parking Current</i> and <i>parameter 2-07 Parking Time</i> accordingly.
[2]	Rotor Det. w/ Parking	

1-71 Start Delay		
Range:	Function:	
00 s* [0 - 300 s]	Enter the time delay between the start command and the time when the frequency converter supplies the power to the motor. This parameter is related to the start function selected in <i>parameter 1-72 Start Function</i> .	

1-72 Start Function		
Option:	Function:	
		Select the start function during start delay. This parameter is linked to <i>parameter 1-71 Start Delay</i> .
[0]	DC Hold/ Motor Preheat	Energizes the motor with a DC hold current (<i>parameter 2-00 DC Hold/Preheat Current</i>) during the start delay time.
[2]	Coast	Motor coasted during the start delay time (inverter off). Available selections depend on <i>parameter 1-10 Motor Construction</i> : [0] Asynchron: <ul style="list-style-type: none"> [2] Coast. [0] DC hold. [1] PM non-salient: <ul style="list-style-type: none"> [2] Coast.

1-73 Flying Start		
Option:	Function:	
		This function makes it possible to catch a motor that is spinning freely due to a mains dropout. When <i>parameter 1-73 Flying Start</i> is enabled, <i>parameter 1-71 Start Delay</i> has no function. Search direction for flying start is linked to the setting in <i>parameter 4-10 Motor Speed Direction</i> .

1-73 Flying Start		
Option:	Function:	
		[0] Clockwise: Flying start searches in clockwise direction. If not successful, a DC brake is carried out. [2] Both Directions: The flying start first makes a search in the direction determined by the last reference (direction). If the speed is not found, it makes a search in the other direction. If not successful, a DC brake is activated in the time set in <i>parameter 2-02 DC Braking Time</i> . Start then takes place from 0 Hz.
[0]	Disabled	Select [0] Disable if this function is not required.
[1]	Enabled	Select [1] Enable to enable the frequency converter to catch and control a spinning motor. The parameter is always set to [1] Enable when <i>parameter 1-10 Motor Construction</i> = [1] PM non-salient. Important related parameters: <ul style="list-style-type: none"> <i>Parameter 1-58 Flying Start Test Pulses Current.</i> <i>Parameter 1-59 Flying Start Test Pulses Frequency.</i> <i>Parameter 1-70 Start Mode.</i> <i>Parameter 2-03 DC Brake Cut In Speed [RPM].</i> <i>Parameter 2-04 DC Brake Cut In Speed [Hz].</i> <i>Parameter 2-06 Parking Current.</i> <i>Parameter 2-07 Parking Time.</i>

When *parameter 1-73 Flying Start* is enabled, *parameter 1-71 Start Delay* has no function.

The flying start function used for PM motors is based on an initial speed estimation. The speed is always estimated immediately after an active start signal is given. Based on the setting of *parameter 1-70 Start Mode*, the following happens:

Parameter 1-70 Start Mode = [0] Rotor Detection:

If the speed estimate comes out as higher than 0 Hz, the frequency converter catches the motor at that speed and resumes normal operation. Otherwise, the frequency converter estimates the rotor position and starts normal operation from there.

Parameter 1-70 Start Mode=[1] Parking:

If the speed estimate comes out lower than the setting in *parameter 1-59 Flying Start Test Pulses Frequency*, the parking function is engaged (see *parameter 2-06 Parking Current* and *parameter 2-07 Parking Time*). Otherwise, the frequency converter catches the motor at that speed and resumes normal operation. Refer to the description of *parameter 1-70 Start Mode* for recommended settings.

Current limitations of the flying start principle used for PM motors:

- The speed range is up to 100% nominal speed or the field weakening speed (whichever is lowest).
- PMSM with high back EMF (>300 VLL(rms)) and high-winding inductance (>10 mH) needs more time for reducing short-circuit current to 0 and may be susceptible to error in estimation.
- Current testing limited to a speed range up to 300 Hz. For certain units, the limit is 250 Hz; all 200–240 V units up to and including 2.2 kW (3 hp) and all 380–480 V units up to and including 4 kW (5.4 hp).
- Current testing limited to a machine power size up to 22 kW (30 hp).
- Prepared for salient pole machine (IPMSM) but not yet verified on those types of machine.
- For high-inertia applications (where the load inertia is more than 30 times larger than the motor inertia), a brake resistor is recommended to avoid overvoltage trip during high-speed engagement of the flying-start function.

1-79 Pump Start Max Time to Trip		
Range:	Function:	
0 s* [0 - 3600.0 s]	If the motor does not reach the speed specified in <i>parameter 1-86 Trip Speed Low [RPM]</i> within the time specified in this parameter, the frequency converter trips. The time in this parameter includes the time specified in <i>parameter 1-71 Start Delay</i> . For instance, if the value in <i>parameter 1-71 Start Delay</i> is more or equal to the value in <i>parameter 1-79 Pump Start Max Time to Trip</i> , the frequency converter never starts.	

3.3.12 1-8* Stop Adjustments

1-80 Function at Stop		
Option:	Function:	
		Select the frequency converter function after a stop command or after the speed is ramped down to the settings in <i>parameter 1-81 Min Speed for Function at Stop [RPM]</i> . Available selections depend on <i>parameter 1-10 Motor Construction</i> : [0] Asynchron: <ul style="list-style-type: none"> • [0] Coast. • [1] DC hold. [1] PM non-salient: <ul style="list-style-type: none"> • [0] Coast.
[0] *	Coast	Leaves the motor in free mode.
[1]	DC Hold/ Motor Preheat	Energizes the motor with a DC hold current (see <i>parameter 2-00 DC Hold/Preheat Current</i>).
[2]	Motor check, warning	
[6]	Motor check, alarm	

1-81 Min Speed for Function at Stop [RPM]		
Range:	Function:	
Size related* [0 - 600 RPM]	Set the speed at which to activate <i>parameter 1-80 Function at Stop</i> .	

1-82 Min Speed for Function at Stop [Hz]		
Range:	Function:	
Size related* [0 - 20.0 Hz]	Set the output frequency at which to activate <i>parameter 1-80 Function at Stop</i> .	

3.3.13 Advanced Minimum Speed Monitoring for Submersible Pumps

Some pumps are sensitive to operating at low speed. Insufficient cooling or lubrication at low speed are typical reasons.

Under overload conditions, the frequency converter protects itself using its integral protection features, which include lowering the speed. For example, the current limit controller can lower the speed. Sometimes, the speed may go lower than the speed specified in *parameter 4-11 Motor Speed Low Limit [RPM]* and *parameter 4-12 Motor Speed Low Limit [Hz]*.

If the speed drops below a certain value, the advanced minimum-speed monitoring feature trips the frequency converter. If the pump motor does not reach the speed specified in *parameter 1-86 Trip Speed Low [RPM]* within the time specified in *parameter 1-79 Pump Start Max Time to Trip* (ramping up takes too long), the frequency converter trips. Timers for *parameter 1-71 Start Delay* and *parameter 1-79 Pump Start Max Time to Trip* start at the same time when the start command is issued. For instance, this means that if the value in *parameter 1-71 Start Delay* is more than or equal to the value in *parameter 1-79 Pump Start Max Time to Trip*, the frequency converter never starts.

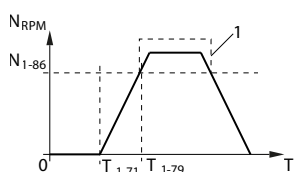

T ₁₋₇₁	Parameter 1-71 Start Delay.
T ₁₋₇₉	Parameter 1-79 Pump Start Max Time to Trip. This time includes the time in T ₁₋₇₁ .
N ₁₋₈₆	Parameter 1-86 Trip Speed Low [RPM]. If the speed drops below this value during normal operation, the frequency converter trips.
1	Normal operation.

Figure 3.11 Advanced Minimum Speed Monitoring

1-86 Trip Speed Low [RPM]	
Range:	Function:
Size related* [0 - par. 4-13 RPM]	<p>NOTICE!</p> <p>This parameter is only available if <i>parameter 0-02 Motor Speed Unit</i> is set to [1] RPM.</p> <p>Enter the low limit for the motor speed at which the frequency converter trips. If the value is 0, the function is not active. If the speed at any time after the start (or during a stop) drops below the value in the parameter, the frequency converter trips with <i>alarm 49, Speed Limit</i>.</p>

1-87 Trip Speed Low [Hz]	
Range:	Function:
Size related* [0 - par. 4-14 Hz]	<p>NOTICE!</p> <p>This parameter is only available if <i>parameter 0-02 Motor Speed Unit</i> is set to [1] Hz.</p>

1-87 Trip Speed Low [Hz]	
Range:	Function:
	Enter the low limit for the motor speed at which the frequency converter trips. If the value is 0, the function is not active. If the speed at any time after the start (or during a stop) drops below the value in the parameter, the frequency converter trips with <i>alarm 49, Speed Limit</i> .

3.3.14 1-9* Motor Temperature

1-90 Motor Thermal Protection	
Option:	Function:
	<p>Motor thermal protection can be implemented using a range of techniques:</p> <ul style="list-style-type: none"> Via a PTC sensor in the motor windings connected to 1 of the analog or digital inputs (<i>parameter 1-93 Thermistor Source</i>). See <i>chapter 3.3.15 PTC Thermistor Connection</i>. Via calculation (ETR = Electronic Thermal Relay) of the thermal load, based on the actual load and time. The calculated thermal load is compared with the rated motor current $I_{M,N}$ and the rated motor frequency $f_{M,N}$. See <i>chapter 3.3.16 ETR</i> and <i>chapter 3.3.17 ATEX ETR</i>. Via a mechanical thermal switch (Klixon type). See <i>chapter 3.3.18 Klixon</i>. <p>For the North American market: The ETR functions provide class 20 motor overload protection in accordance with NEC.</p>
[0]	<p>No protection</p> <p>Continuously overloaded motor, when no warning or trip of the frequency converter is required.</p>
[1]	<p>Thermistor warning</p> <p>Activates a warning when the connected thermistor or KTY sensor in the motor reacts if motor overtemperature occurs.</p>
[2]	<p>Thermistor trip</p> <p>Stops (trips) the frequency converter when the connected thermistor or KTY sensor in the motor reacts if motor overtemperature occurs. The thermistor cutout value must be more than 3 kΩ. Integrate a thermistor (PTC sensor) in the motor for winding protection.</p>
[3]	<p>ETR warning 1</p> <p>Calculates the load when set-up 1 is active and activates a warning on the display when</p>

3

1-90 Motor Thermal Protection

Option:	Function:
	the motor is overloaded. Program a warning signal via 1 of the digital outputs.
[4] ETR trip 1	Calculates the load when set-up 1 is active and stops (trips) the frequency converter when the motor is overloaded. Program a warning signal via 1 of the digital outputs. The signal appears if there is a warning and if the frequency converter trips (thermal warning).
[5] ETR warning 2	
[6] ETR trip 2	
[7] ETR warning 3	
[8] ETR trip 3	
[9] ETR warning 4	
[10] ETR trip 4	
[20] ATEX ETR	Activates the thermal monitoring function for Ex-e motors for ATEX. Enables <i>parameter 1-94 ATEX ETR cur.lim. speed reduction</i> , <i>parameter 1-98 ATEX ETR interpol. points freq.</i> , and <i>parameter 1-99 ATEX ETR interpol. points current</i> .

NOTICE!

If [20] ATEX ETR is selected, follow the instructions in the dedicated chapter of the *design guide* and the instructions provided by the motor manufacturer.

NOTICE!

If [20] ATEX ETR is selected, set *parameter 4-18 Current Limit* to 150%.

3.3.15 PTC Thermistor Connection

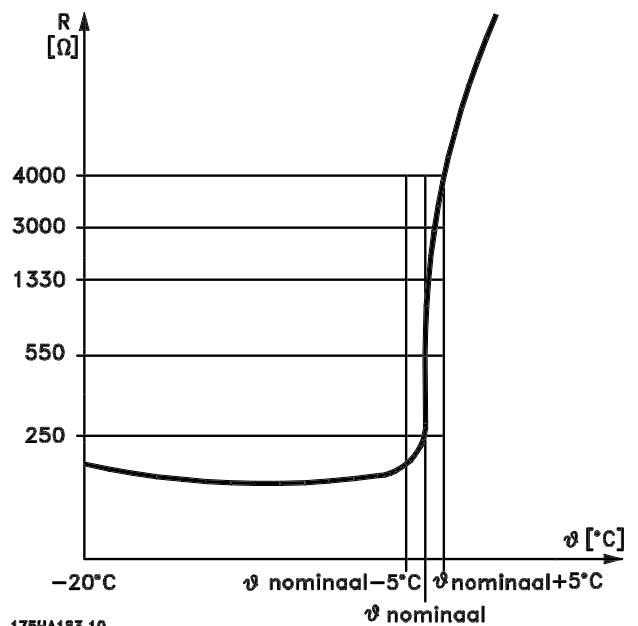

Figure 3.12 PTC Profile

Using a digital input and 10 V as supply:
Example: The frequency converter trips when the motor temperature is too high.

Parameter set-up:

- Set *parameter 1-90 Motor Thermal Protection* to [2] *Thermistor Trip*.
- Set *parameter 1-93 Thermistor Source* to [6] *Digital Input*.

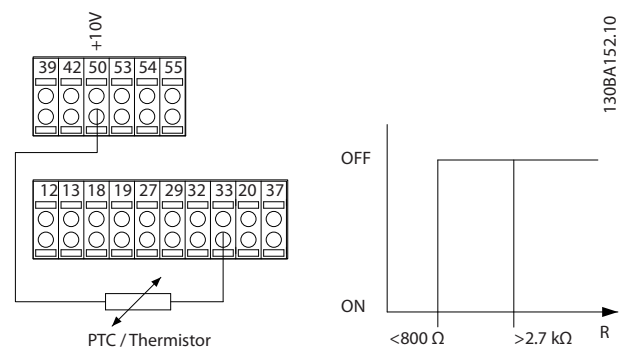

Figure 3.13 PTC Thermistor Connection - Digital Input

Using an analog input and 10 V as supply:

Example: The frequency converter trips when the motor temperature is too high.

Parameter set-up:

- Set parameter 1-90 Motor Thermal Protection to [2] Thermistor Trip.
- Set parameter 1-93 Thermistor Source to [2] Analog Input 54.

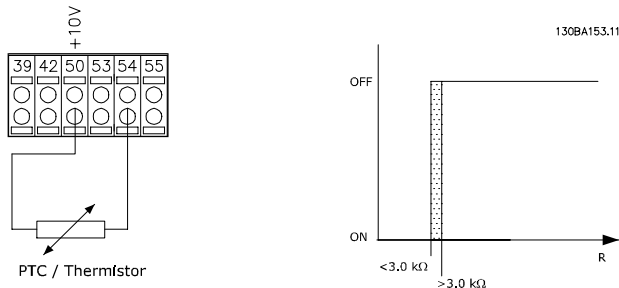

Figure 3.14 PTC Thermistor Connection - Analog Input

Input digital/analog	Supply voltage	Threshold cutout values
Digital	10 V	<800 Ω⇒2.7 kΩ
Analog	10 V	<3.0 kΩ⇒3.0 kΩ

Table 3.10 Threshold Cutout Values

NOTICE!

Check that the selected supply voltage follows the specification of the used thermistor element.

3.3.16 ETR

The calculations estimate the need for a lower load at lower speed due to less cooling from the fan incorporated in the motor.

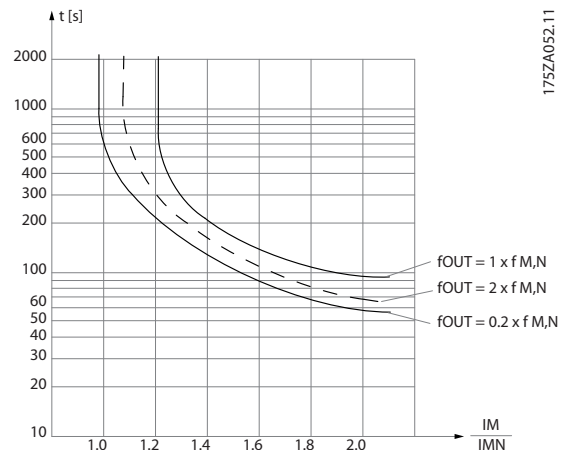

Figure 3.15 ETR Profile

3.3.17 ATEX ETR

The VLT® PTC Thermistor Card MCB 112 offers ATEX-approved monitoring of motor temperature. Alternatively, an external ATEX-approved PTC protection device can be used.

NOTICE!

Only use ATEX Ex-e-approved motors for this function. See the motor nameplate, approval certificate, datasheet, or contact motor supplier.

When controlling an Ex-e motor with increased safety, it is important to ensure certain limitations. The parameters that must be programmed are presented in Table 3.11.

Function	Setting
Parameter 1-90 Motor Thermal Protection	[20] ATEX ETR
Parameter 1-94 ATEX ETR cur.lim. speed reduction	20%
Parameter 1-98 ATEX ETR interpol. points freq.	Motor nameplate.
Parameter 1-99 ATEX ETR interpol. points current	
Parameter 1-23 Motor Frequency	Enter the same value as for parameter 4-19 Max Output Frequency.
Parameter 4-19 Max Output Frequency	Motor nameplate, possibly reduced for long motor cables, sine-wave filter, or reduced supply voltage.
Parameter 4-18 Current Limit	Forced to 150% by 1-90 [20]
Parameter 5-15 Terminal 33 Digital Input	[80] PTC Card 1
Parameter 5-19 Terminal 37 Safe Stop	[4] PTC 1 Alarm
Parameter 14-01 Switching Frequency	Check that the default value fulfills the requirement from the motor nameplate. If not, use a sine-wave filter.
Parameter 14-26 Trip Delay at Inverter Fault	0

Table 3.11 Parameters

NOTICE!

Compare the minimum switching frequency requirement stated by the motor manufacturer to the minimum switching frequency of the frequency converter, the default value in *parameter 14-01 Switching Frequency*. If the frequency converter does not meet this requirement, use a sine-wave filter.

More information about ATEX ETR thermal monitoring can be found in *Application Note for FC 300 ATEX ETR Thermal Monitoring Function*.

3.3.18 Klixon

The Klixon type thermal circuit breaker uses a KLIXON® metal dish. At a predetermined overload, the heat caused by the current through the disc causes a trip.

Using a digital input and 24 V as supply:
Example: The frequency converter trips when the motor temperature is too high.

Parameter set-up:

- Set *parameter 1-90 Motor Thermal Protection* to [2] *Thermistor Trip*.
- Set *parameter 1-93 Thermistor Source* to [6] *Digital Input*.

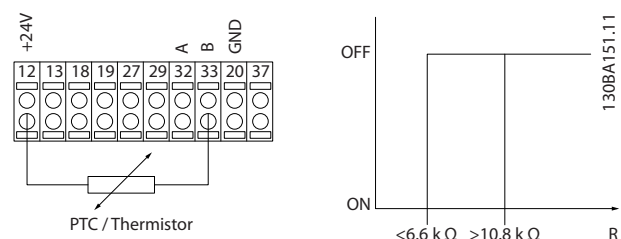

Figure 3.16 Thermistor Connection

1-91 Motor External Fan		
Option:	Function:	
[0] *	No	No external fan is required, that is the motor is derated at low speed.
[1]	Yes	Applies an external motor fan (external ventilation), so no derating of the motor is required at low speed. The upper curve in <i>Figure 3.15</i> ($f_{out} = 1 \times f_{M,N}$) is followed if the motor current is lower than nominal motor current (see <i>parameter 1-24 Motor Current</i>). If the motor current exceeds nominal current, the operation time still decreases as if no fan was installed.

1-93 Thermistor Source	
Option:	Function:
	<p>NOTICE!</p> <p>This parameter cannot be adjusted while the motor is running.</p> <p>NOTICE!</p> <p>Set digital input to [0] PNP - Active at 24 V in <i>parameter 5-00 Digital I/O Mode</i>.</p> <p>Select the input to which the thermistor (PTC sensor) should be connected. An analog</p>

1-93 Thermistor Source		
Option:	Function:	
		input option [1] Analog Input 53 or [2] Analog Input 54 cannot be selected if the analog input is already in use as a reference source (selected in <i>parameter 3-15 Reference 1 Source</i> , <i>parameter 3-16 Reference 2 Source</i> , or <i>parameter 3-17 Reference 3 Source</i>). When using VLT [®] PTC Thermistor Card MCB 112, always select [0] None.
[0] *	None	
[1]	Analog Input 53	
[2]	Analog Input 54	
[3]	Digital input 18	
[4]	Digital input 19	
[5]	Digital input 32	
[6]	Digital input 33	

1-95 KTY Sensor Type		
Option:	Function:	
		Select the type of the thermistor sensor.
[0] *	KTY Sensor 1	1 kΩ at 100 °C (212 °F).
[1]	KTY Sensor 2	1 kΩ at 25 °C (77 °F).
[2]	KTY Sensor 3	2 kΩ at 25 °C (77 °F).

1-96 KTY Thermistor Resource		
Option:	Function:	
		Select analog input terminal 54 as a thermistor sensor input. Terminal 54 cannot be selected as thermistor source if otherwise used as reference (see <i>parameter 3-15 Reference Resource 1</i> to <i>parameter 3-17 Reference Resource 3</i>). NOTICE! Connection of thermistor sensor between terminals 54 and 55 (GND). See <i>chapter 3.3.15 PTC Thermistor Connection</i> .
[0] *	None	
[2]	Analog input 54	

1-97 KTY Threshold level		
Range:	Function:	
80 °C*	[-40 - 140 °C]	Select the thermistor sensor threshold level for motor thermal protection.

3.4 Parameters 2-** Brakes

3.4.1 2-0* DC brakes

Parameter group for configuring the DC brake and DC hold functions.

2-00 DC Hold/Preheat Current		
Range:	Function:	
50 %* [0 - 160 %]	<p>NOTICE! Parameter 2-00 DC Hold/Preheat Current is not effective when parameter 1-10 Motor Construction = [1] PM, non-salient SPM.</p> <p>NOTICE! The maximum value depends on the rated motor current. Avoid 100% current for too long. It may damage the motor.</p> <p>Enter a value for holding current as a percentage of the rated motor current $I_{M,N}$ set in parameter 1-24 Motor Current. 100% DC hold current corresponds to $I_{M,N}$.</p> <p>This parameter holds the motor (holding torque) or preheats the motor.</p> <p>This parameter is active if [1] DC hold/Preheat is selected in parameter 1-80 Function at Stop.</p>	

2-01 DC Brake Current		
Range:	Function:	
50 %* [0 - 1000 %]	<p>NOTICE! The maximum value depends on the rated motor current. Avoid 100% current for too long. It may damage the motor.</p> <p>Enter a value for current as a percentage of the rated motor current $I_{M,N}$, see parameter 1-24 Motor Current. 100% DC brake current corresponds to $I_{M,N}$.</p> <p>DC brake current is applied on a stop command, when the speed is lower than the limit set in:</p> <ul style="list-style-type: none"> Parameter 2-03 DC Brake Cut In Speed [RPM]. Parameter 2-04 DC Brake Cut In Speed [Hz], when the DC brake inverse function is active, or via the serial communication port. <p>The braking current is active during the time period set in parameter 2-02 DC Braking Time.</p>	

2-02 DC Braking Time		
Range:	Function:	
10 s*	[0 - 60 s]	Set the duration of the DC brake current set in parameter 2-01 DC Brake Current, once activated.

2-03 DC Brake Cut In Speed [RPM]		
Range:	Function:	
Size related*	[0 - 0 RPM]	<p>NOTICE! Parameter 2-03 DC Brake Cut In Speed [RPM] is not effective when parameter 1-10 Motor Construction = [1] PM, non-salient SPM.</p> <p>Set the DC brake cut-in speed to activate the DC brake current set in parameter 2-01 DC Brake Current after a stop command.</p> <p>When parameter 1-10 Motor Construction is set to [1] PM non-salient SPM, this value is limited to 0 RPM (OFF).</p>

2-04 DC Brake Cut-in Speed [Hz]		
Range:	Function:	
0.0 Hz*	[0.0 - par. 4-14 Hz]	<p>NOTICE! Parameter 2-04 DC Brake Cut-in Speed [Hz] is not effective when parameter 1-10 Motor Construction = [1] PM, non-salient SPM.</p> <p>Set the DC brake cut-in speed for activation of the DC brake current set in parameter 2-01 DC Brake Current after a stop command.</p>

2-06 Parking Current		
Range:	Function:	
50 %*	[0 - 1000 %]	<p>NOTICE! Parameter 2-06 Parking Current and parameter 2-07 Parking Time: Only active if [1] PM, non-salient SPM is selected in parameter 1-10 Motor Construction.</p> <p>Set current as percentage of rated motor current, parameter 1-24 Motor Current. Active with parameter 1-73 Flying Start. The parking current is active during the time period set in parameter 2-07 Parking Time.</p>

2-07 Parking Time		
Range:		Function:
3 s*	[0.1 - 60 s]	Set the duration of the parking current time set in <i>parameter 2-06 Parking Current</i> . Active with <i>parameter 1-73 Flying Start</i> . NOTICE! <i>Parameter 2-07 Parking Time is only active when [1] PM, non-salient SPM is selected in parameter 1-10 Motor Construction.</i>

3.4.2 2-1* Brake Energy Funct.

Parameter group for selecting dynamic brake parameters. Only valid for frequency converters with brake chopper.

2-10 Brake Function		
Option:	Function:	
	Available selections depend on <i>parameter 1-10 Motor Construction</i> : [0] Asynchronous: <ul style="list-style-type: none"> [0] Off. [1] Resistor brake. [2] AC braking. [1] PM non-salient: <ul style="list-style-type: none"> [0] Off. [1] Resistor brake. 	
[0]	Off	No brake resistor installed.
[1]	Resistor brake	Brake resistor incorporated in the system, for dissipation of surplus brake energy as heat. Connecting a brake resistor allows a higher DC-link voltage during braking (generating operation). The resistor brake function is only active in frequency converters with an integral dynamic brake.
[2]	AC brake	AC braking only works in compressor torque mode in <i>parameter 1-03 Torque Characteristics</i> .

2-11 Brake Resistor (ohm)		
Range:		Function:
Size related*	[5 - 65535 Ohm]	Set the brake resistor value in Ω. This value is used for monitoring the power to the brake resistor in <i>parameter 2-13 Brake Power Monitoring</i> . This parameter is only active in frequency converters with an integral dynamic brake. Use this parameter for values without decimals. For a selection with 2 decimals, use <i>parameter 30-81 Brake Resistor (ohm)</i> .

2-12 Brake Power Limit (kW)		
Range:		Function:
Size related*	[0.001 - 2000.000 kW]	NOTICE! This parameter is only active in frequency converters with an integral dynamic brake. Set the monitoring limit of the brake power transmitted to the resistor. The monitoring limit is a product of the maximum duty cycle (120 s) and the maximum power of the brake resistor at that duty cycle. See the formulas below. For 200–240 V units: $P_{resistor} = \frac{390^2 \times dutytime}{R \times 120}$ For 380–480 V units: $P_{resistor} = \frac{778^2 \times dutytime}{R \times 120}$ For 525–600 V units: $P_{resistor} = \frac{943^2 \times dutytime}{R \times 120}$

2-13 Brake Power Monitoring		
Option:	Function:	
	NOTICE! This parameter is only active in frequency converters with an integral dynamic brake. This parameter enables monitoring of the power to the brake resistor. The power is calculated based on the resistance (<i>parameter 2-11 Brake Resistor (ohm)</i>), the DC-link voltage, and the resistor duty time.	
[0] *	Off	No brake power monitoring is required. If power monitoring is set to [0] Off or [1] Warning, the brake function remains active even if the monitoring limit is exceeded. This may lead to thermal overload of the resistor. It is also possible to generate a warning via a relay/digital output. The measuring accuracy of the power monitoring depends on the accuracy of the resistance of the resistor (better than ±20%).
[1]	Warning 120s	Activates a warning when the power transmitted over 120 s exceeds 100% of the monitoring limit (<i>parameter 2-12 Brake Power Limit (kW)</i>). The warning disappears when the transmitted power drops below 80% of the monitoring limit.

2-13 Brake Power Monitoring		
Option:	Function:	
[2]	Trip 120s	Trips the frequency converter and shows an alarm when the calculated power exceeds 100% of the monitoring limit.
[3]	Warning & trip 120s	Activates both of the above, including warning, trip, and alarm.
[4]	Warning 30s	
[5]	Trip 30s	
[6]	Warning & trip 30s	
[7]	Warning 60s	
[8]	Trip 60s	
[9]	Warning & trip 60s	
[10]	Warning 300s	
[11]	Trip 300s	
[12]	Warning & trip 300s	
[13]	Warning 600s	
[14]	Trip 600s	
[15]	Warning & trip 600s	

2-15 Brake Check		
Option:	Function:	
		<p>NOTICE!</p> <p>Remove a warning arising with [0] Off or [1] Warning by cycling the mains supply. Correct the fault first. For [0] Off or [1] Warning, the frequency converter keeps running even if a fault is found.</p> <p>Select the type of test and monitoring function to check the connection to the brake resistor, or whether a brake resistor is present, and then show a warning or an alarm if a fault occurs. The brake resistor disconnection function is tested during power-up. However, the brake IGBT test is performed when there is no braking. A warning or trip disconnects the brake function.</p> <p>The testing sequence is as follows:</p> <ol style="list-style-type: none"> 1. Measure the DC-link ripple amplitude for 300 ms without braking. 2. Measure the DC-link ripple amplitude for 300 ms with the brake turned on.

2-15 Brake Check		
Option:	Function:	
		<ol style="list-style-type: none"> 3. If the DC-link ripple amplitude while braking is lower than the DC-link ripple amplitude before braking +1%, the brake check fails. If brake check fails, a warning or alarm is returned. 4. If the DC-link ripple amplitude while braking is higher than the DC-link ripple amplitude before braking +1%, the brake check is OK.
[0]	Off	Monitors brake resistor and brake IGBT for a short circuit during operation. If a short circuit occurs, a warning appears.
[1]	Warning	Monitors brake resistor and brake IGBT for a short circuit and runs a test for brake resistor disconnection during power-up.
[2]	Trip	Monitors for a short circuit or disconnection of the brake resistor, or a short circuit of the brake IGBT. If a fault occurs, the frequency converter cuts out while showing an alarm (trip lock).
[3]	Stop and trip	Monitors for a short circuit or disconnection of the brake resistor, or a short circuit of the brake IGBT. If a fault occurs, the frequency converter ramps down to coast and then trips. A trip lock alarm is shown.
[4]	AC brake	Monitors for a short circuit or disconnection of the brake resistor, or a short circuit of the brake IGBT. If a fault occurs, the frequency converter performs a controlled ramp down.

2-16 AC Brake Max. Current		
Range:	Function:	
100.0 %*	[0.0 - 1000.0 %]	<p>NOTICE!</p> <p>Parameter 2-16 AC Brake Max. Current is not effective when parameter 1-10 Motor Construction = [1] PM, non-salient SPM.</p> <p>Enter the maximum allowed current when using AC braking to avoid overheating of motor windings.</p>

2-17 Over-voltage Control		
Option:	Function:	
[0]	Disabled	No OVC required.
[2] *	Enabled	Activates OVC.

2-19 Over-voltage Gain		
Range:		Function:
100 %*	[10 - 200 %]	Select overvoltage gain.

3.5 Parameters 3-** Reference/Ramps

3.5.1 3-0* Reference Limits

3-02 Minimum Reference		
Range:		Function:
Size related*	[-999999.999 - par. 3-03 ReferenceFeedbackUnit]	Enter the minimum value for the remote reference. The minimum reference value and unit match the configuration selection made in <i>parameter 1-00 Configuration Mode</i> and <i>parameter 20-12 Reference/Feedback Unit</i> .

3-03 Maximum Reference		
Range:		Function:
Size related*	[par. 3-02 - 999999.999 ReferenceFeedbackUnit]	Enter the maximum acceptable value for the remote reference. The maximum reference value and unit match the configuration option selected in <i>parameter 1-00 Configuration Mode</i> and <i>parameter 20-12 Reference/Feedback Unit</i> .

3-04 Reference Function		
Option:		Function:
[0] *	Sum	Sums both external and preset reference sources.
[1]	External/Preset	Use either the preset or the external reference source. Shift between external and preset via a command or a digital input.

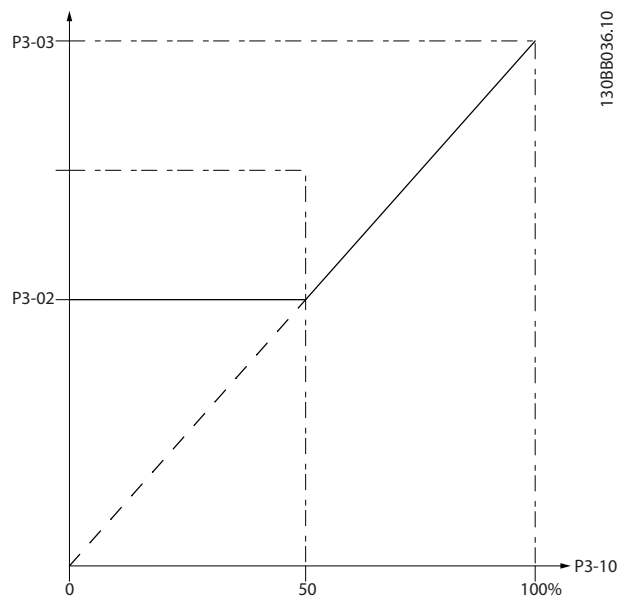

Figure 3.17 Preset Reference

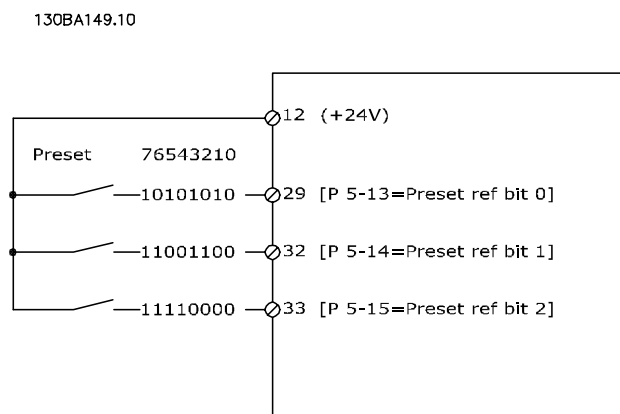

Figure 3.18 Preset Reference Scheme

3.5.2 3-1* References

Select the preset references. Select *Preset ref. bit 0/1/2 [16], [17], or [18]* for the corresponding digital inputs in *parameter group 5-1* Digital Inputs*.

3-10 Preset Reference		
Array [8]		
Range:		Function:
0 %*	[-100 - 100 %]	Enter up to 8 different preset references (0-7) in this parameter, using array programming. The preset reference is stated as a percentage of the value Ref _{MAX} (<i>parameter 3-03 Maximum Reference</i>). When using preset references, select <i>Preset ref. bit 0/1/2 [16], [17] or [18]</i> for the corresponding digital inputs in <i>parameter group 5-1* Digital Inputs</i> .

3-11 Jog Speed [Hz]		
Range:		Function:
Size related*	[0 - par. 4-14 Hz]	The jog speed is a fixed output speed at which the frequency converter is running when the jog function is activated. See also <i>parameter 3-19 Jog Speed [RPM]</i> and <i>parameter 3-80 Jog Ramp Time</i> .

3-13 Reference Site		
Option:	Function:	
		Select which reference site to activate.
[0] *	Linked to Hand / Auto	Use local reference when in hand-on mode, or remote reference when in auto-on mode.
[1]	Remote	Use remote reference in both hand-on mode and auto-on mode.
[2]	Local	Use local reference in both hand-on mode and auto-on mode. NOTICE! When set to [2] Local, the frequency converter starts with this setting again after a power-down.

3-14 Preset Relative Reference		
Range:	Function:	
0 % * [-100 - 100 %]	The actual reference, X, is increased or decreased with the percentage Y, set in <i>parameter 3-14 Preset Relative Reference</i> . This results in the actual reference Z. Actual reference (X) is the sum of the inputs selected in: <ul style="list-style-type: none"> Parameter 3-15 Reference 1 Source. Parameter 3-16 Reference 2 Source. Parameter 3-17 Reference 3 Source. Parameter 8-02 Control Source. 	

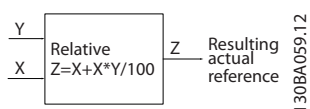

Figure 3.19 Preset Relative Reference

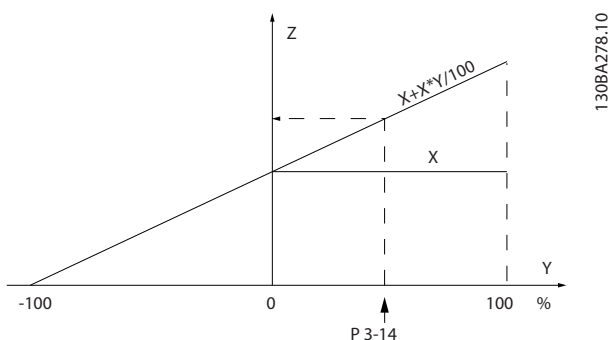

Figure 3.20 Actual Reference

3-15 Reference 1 Source		
Option:	Function:	
		NOTICE! This parameter cannot be adjusted while the motor is running. Select the reference input to be used for the 1 st reference signal: <ul style="list-style-type: none"> Parameter 3-15 Reference 1 Source. Parameter 3-16 Reference 2 Source. Parameter 3-17 Reference 3 Source. Define up to 3 different reference signals. The sum of these reference signals defines the actual reference.
[0]	No function	
[1] *	Analog Input 53	
[2]	Analog Input 54	
[7]	Pulse input 29	
[8]	Pulse input 33	
[20]	Digital pot.meter	
[21]	Analog input X30/11	
[22]	Analog input X30/12	
[23]	Analog Input X42/1	
[24]	Analog Input X42/3	
[25]	Analog Input X42/5	
[29]	Analog Input X48/2	
[30]	Ext. Closed Loop 1	
[31]	Ext. Closed Loop 2	
[32]	Ext. Closed Loop 3	
[33]	PCD Bus Reference	
[35]	Digital input select	The frequency converter selects AI53 or AI54 as the reference source based on the input signal defined in option [42] Ref source bit 0 as 1 of the digital inputs. For more information, see <i>parameter group 5-1* Digital Inputs</i> , option [42] Ref source bit 0.

3-16 Reference 2 Source		
Option:	Function:	
		<p>NOTICE!</p> <p>This parameter cannot be adjusted while the motor is running.</p> <p>Select the reference input to be used for the 2nd reference signal:</p> <ul style="list-style-type: none"> Parameter 3-15 Reference 1 Source. Parameter 3-16 Reference 2 Source. Parameter 3-17 Reference 3 Source. <p>Define up to 3 different reference signals. The sum of these reference signals defines the actual reference.</p>
[0] *	No function	
[1]	Analog Input 53	
[2]	Analog Input 54	
[7]	Pulse input 29	
[8]	Pulse input 33	
[20]	Digital pot.meter	
[21]	Analog input X30/11	
[22]	Analog input X30/12	
[23]	Analog Input X42/1	
[24]	Analog Input X42/3	
[25]	Analog Input X42/5	
[29]	Analog Input X48/2	
[30]	Ext. Closed Loop 1	
[31]	Ext. Closed Loop 2	
[32]	Ext. Closed Loop 3	
[33]	PCD Bus Reference	
[35]	Digital input select	<p>The frequency converter selects AI53 or AI54 as the reference source based on the input signal defined in option [42] Ref source bit 0 as 1 of the digital inputs. For more information, see <i>parameter group 5-1* Digital Inputs</i>, option [42] Ref source bit 0.</p>

3-17 Reference 3 Source		
Option:	Function:	
		<p>NOTICE!</p> <p>This parameter cannot be adjusted while the motor is running.</p> <p>Select the reference input to be used for the 3rd reference signal:</p> <ul style="list-style-type: none"> Parameter 3-15 Reference 1 Source. Parameter 3-16 Reference 2 Source. Parameter 3-17 Reference 3 Source. <p>Define up to 3 different reference signals. The sum of these reference signals defines the actual reference.</p>
[0] *	No function	
[1]	Analog Input 53	
[2]	Analog Input 54	
[7]	Pulse input 29	
[8]	Pulse input 33	
[20]	Digital pot.meter	
[21]	Analog input X30/11	
[22]	Analog input X30/12	
[23]	Analog Input X42/1	
[24]	Analog Input X42/3	
[25]	Analog Input X42/5	
[29]	Analog Input X48/2	
[30]	Ext. Closed Loop 1	
[31]	Ext. Closed Loop 2	
[32]	Ext. Closed Loop 3	
[33]	PCD Bus Reference	
[35]	Digital input select	<p>The frequency converter selects AI53 or AI54 as the reference source based on the input signal defined in option [42] Ref source bit 0 as 1 of the digital inputs. For more information, see <i>parameter group 5-1* Digital Inputs</i>, option [42] Ref source bit 0.</p>

3-19 Jog Speed [RPM]		
Range:	Function:	
Size related*	[0 - par. 4-13 RPM]	Enter a value for the jog speed n_{JOG} , which is a fixed output speed. The frequency converter runs at this speed when the jog function is activated. The maximum limit is defined in <i>parameter 4-13 Motor Speed High Limit [RPM]</i> . See also <i>parameter 3-11 Jog Speed [Hz]</i> and <i>parameter 3-80 Jog Ramp Time</i> .

3-42 Ramp 1 Ramp Down Time		
Range:	Function:	
		ramp-down time should also be long enough to prevent that the generated current exceeds the current limit set in <i>parameter 4-18 Current Limit</i> . See ramp-up time in <i>parameter 3-41 Ramp 1 Ramp Up Time</i> . $par. 3 - 42 = \frac{t_{dec} \times n_{nom} [par. 1 - 25]}{ref [RPM]} [s]$

3.5.3 3-4* Ramp 1

Configure the ramp times for each of the 2 ramps (*parameter group 3-4* Ramp 1* and *parameter group 3-5* Ramp 2*).

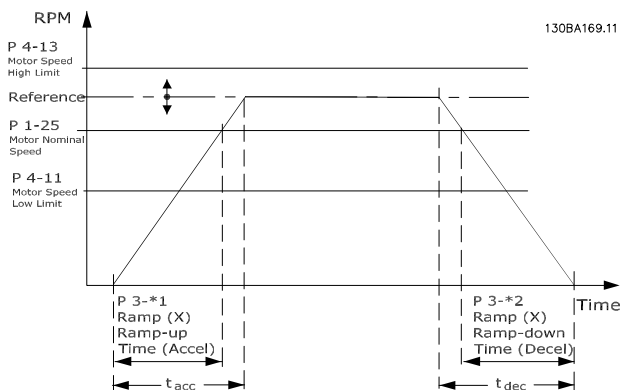

Figure 3.21 Ramp 1

3.5.4 3-5* Ramp 2

To select ramp parameters, see *parameter group 3-4* Ramp 1*.

3-51 Ramp 2 Ramp Up Time		
Range:	Function:	
Size related*	[0.10 - 3600 s]	Enter the ramp-up time, that is the acceleration time from 0 RPM– <i>parameter 1-25 Motor Nominal Speed</i> . Select a ramp-up time such that the output current does not exceed the current limit in <i>parameter 4-18 Current Limit</i> during ramping. See ramp-down time in <i>parameter 3-52 Ramp 2 Ramp Down Time</i> . $par. 3 - 51 = \frac{t_{acc} \times n_{nom} [par. 1 - 25]}{ref [rpm]} [s]$

3-52 Ramp 2 Ramp Down Time		
Range:	Function:	
Size related*	[0.10 - 3600 s]	Enter the ramp-down time, that is the deceleration time from <i>parameter 1-25 Motor Nominal Speed</i> –0 RPM. Select a ramp-down time such that no overvoltage occurs in the inverter due to regenerative operation of the motor, and such that the generated current does not exceed the current limit set in <i>parameter 4-18 Current Limit</i> . See ramp-up time in <i>parameter 3-51 Ramp 2 Ramp Up Time</i> . $par. 3 - 52 = \frac{t_{dec} \times n_{nom} [par. 1 - 25]}{ref [rpm]} [s]$

3-41 Ramp 1 Ramp Up Time		
Range:	Function:	
Size related*	[0.10 - 3600 s]	Enter the ramp-up time, that is the acceleration time from 0 RPM– <i>parameter 1-25 Motor Nominal Speed</i> . Select a ramp-up time such that the output current does not exceed the current limit in <i>parameter 4-18 Current Limit</i> during ramping. See ramp-down time in <i>parameter 3-42 Ramp 1 Ramp Down Time</i> . $par. 3 - 41 = \frac{t_{acc} \times n_{nom} [par. 1 - 25]}{ref [RPM]} [s]$

3-42 Ramp 1 Ramp Down Time		
Range:	Function:	
Size related*	[0.10 - 3600 s]	Enter the ramp-down time, that is the deceleration time from <i>parameter 1-25 Motor Nominal Speed</i> –0 RPM. Select a ramp-down time preventing overvoltage from arising in the inverter due to regenerative operation of the motor. The

3.5.5 3-8* Other Ramps

3-80 Jog Ramp Time		
Range:	Function:	
Size related* [0.1 - 3600 s]	Enter the jog ramp time, that is the acceleration/deceleration time between 0 RPM and the nominal motor speed ($n_{M,N}$) (set in <i>parameter 1-25 Motor Nominal Speed</i>). Ensure that the resulting output current required for the given jog ramp time does not exceed the current limit in <i>parameter 4-18 Current Limit</i> . The jog ramp time starts after activating a jog signal via the control panel, a selected digital input, or the serial communication port.	
	$par. 3 - 80 = \frac{t_{jog} \times n_{nom} [par. 1 - 25]}{jog\ speed [par. 3 - 19]} [s]$	

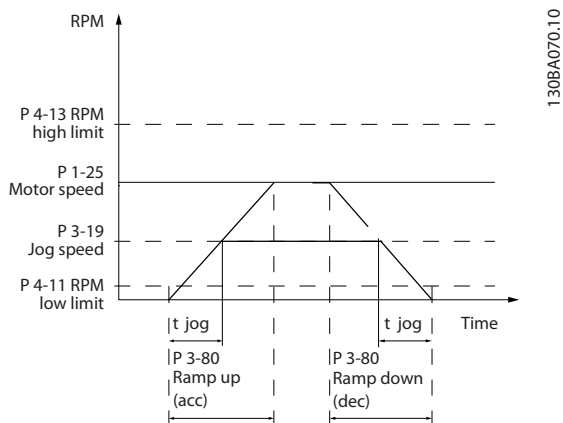

Figure 3.22 Jog Ramp Time

3-84 Initial Ramp Time		
Range:	Function:	
0 s* [0 - 60 s]	Enter the initial ramp-up time from zero speed to motor speed low limit, <i>parameter 4-11 Motor Speed Low Limit [RPM]</i> or <i>parameter 4-12 Motor Speed Low Limit [Hz]</i> . Submersible deep-well pumps can be damaged by running below minimum speed. A fast ramp time below minimum pump speed is recommended. This parameter may be applied as a fast ramp rate from zero speed to motor speed low limit. See <i>Figure 3.23</i> .	

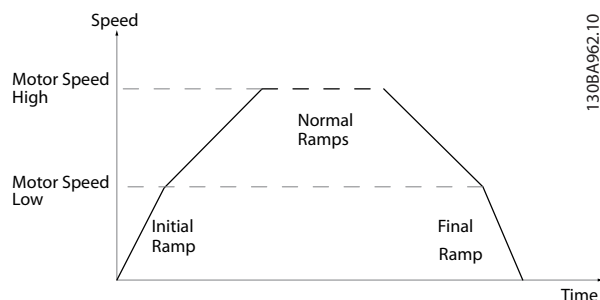

Figure 3.23 Initial and Final Ramp Time

3-85 Check Valve Ramp Time		
Range:	Function:	
0 s* [0 - 650 s]	To protect ball check valves in a stop situation, the check valve ramp can be utilized as a slow ramp rate from <i>parameter 4-11 Motor Speed Low Limit [RPM]</i> or <i>parameter 4-12 Motor Speed Low Limit [Hz]</i> to check valve ramp end speed, set in <i>parameter 3-86 Check Valve Ramp End Speed [RPM]</i> or <i>parameter 3-87 Check Valve Ramp End Speed [Hz]</i> . When <i>parameter 3-85 Check Valve Ramp Time</i> is different from 0 s, the check valve ramp time is effectuated and is used to ramp down the speed from motor speed low limit to the check valve end speed in <i>parameter 3-86 Check Valve Ramp End Speed [RPM]</i> or <i>parameter 3-87 Check Valve Ramp End Speed [Hz]</i> . See <i>Figure 3.24</i> .	

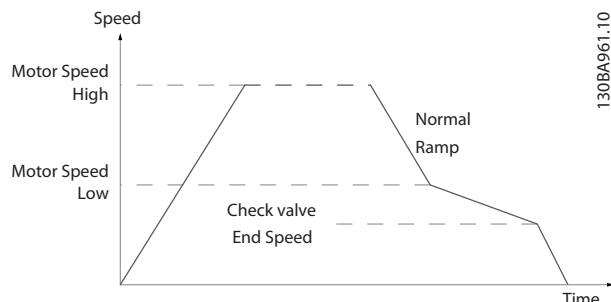

Figure 3.24 Check Valve Ramp

3-86 Check Valve Ramp End Speed [RPM]		
Range:	Function:	
Size related* [0 - par. 4-11 RPM]	Set the speed in [RPM] below motor speed low limit where the check valve is expected to be closed. Check that the valve is no longer active. See <i>Figure 3.24</i> .	

3-87 Check Valve Ramp End Speed [HZ]		
Range:	Function:	
Size related* [0 - par. 4-12 Hz]	Set the speed in [Hz] below motor speed low limit where the check valve ramp is no longer active. See <i>Figure 3.24</i> .	

3-88 Final Ramp Time		
Range:	Function:	
0 s* [0 - 60 s]	Enter the final ramp time to be used when ramping down from <i>parameter 4-11 Motor Speed Low Limit [RPM]</i> or <i>parameter 4-12 Motor Speed Low Limit [Hz]</i> to zero speed. Submersible deep-well pumps can be damaged by running below minimum speed. A fast ramp time below minimum pump speed is recommended. This parameter may be applied as a fast ramp rate from <i>parameter 4-11 Motor Speed Low Limit [RPM]</i> or <i>parameter 4-12 Motor Speed Low Limit [Hz]</i> to zero speed. See <i>Figure 3.23</i> .	

3.5.6 3-9* Digital Pot.Meter

Use the digital potentiometer function to increase or decrease the actual reference by adjusting the set-up of the digital inputs using the functions increase, decrease, or clear. To activate the function, at least 1 digital input must be set to increase or decrease.

3-90 Step Size		
Range:	Function:	
0.10 %* [0.01 - 200 %]	Enter the increment size required for increase/decrease as a percentage of the synchronous motor speed, n_s . If increase/decrease is activated, the resulting reference is increased or decreased by the value set in this parameter.	

3-91 Ramp Time		
Range:	Function:	
1 s [0 - 3600 s]	Enter the ramp time, that is the time for adjustment of the reference 0–100% of the specified digital potentiometer function (increase, decrease, or clear). If increase/decrease is activated for longer than the ramp delay period specified in <i>parameter 3-95 Ramp Delay</i> , the actual reference is ramped up/down according to this ramp time. The ramp time is defined as the time spent to adjust the reference by the step size specified in <i>parameter 3-90 Step Size</i> .	

3-92 Power Restore		
Option:	Function:	
[0] * Off	Resets the digital potentiometer reference to 0% after power-up.	
[1] On	Restores the most recent digital potentiometer reference at power-up.	

3-93 Maximum Limit		
Range:	Function:	
100 %* [-200 - 200 %]	Set the maximum allowed value for the resulting reference. This is recommended if the digital potentiometer is used for fine-tuning of the resulting reference.	

3-94 Minimum Limit		
Range:	Function:	
0 %* [-200 - 200 %]	Set the minimum allowed value for the resulting reference. This is recommended if the digital potentiometer is used for fine-tuning of the resulting reference.	

3-95 Ramp Delay		
Range:	Function:	
Size related* [0 - 0]	Enter the delay required from activation of the digital potentiometer function until the frequency converter starts to ramp the reference. With a delay of 0 ms, the reference starts to ramp when increase/decrease is activated. See also <i>parameter 3-91 Ramp Time</i> .	

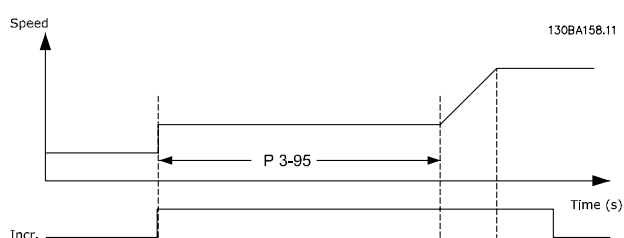

Figure 3.25 Ramp Delay Case 1

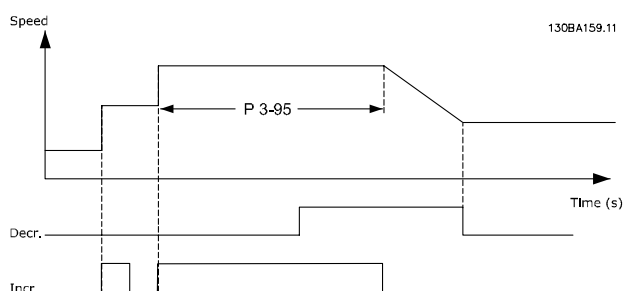

Figure 3.26 Ramp Delay Case 2

3.6 Parameters 4-** Limits/Warnings

3.6.1 4-1* Motor Limits

Define torque, current, and speed limits for the motor, and the reaction of the frequency converter when the limits are exceeded.

A limit may generate a message in the display. A warning always generates a message in the display or on the fieldbus. A monitoring function may initiate a warning or a trip, after which the frequency converter stops and generates an alarm message.

4-10 Motor Speed Direction		
Option:	Function:	
		Selects the motor speed direction required. When <i>parameter 1-00 Configuration Mode</i> is set to [3] <i>Closed loop</i> , the parameter default is changed to [0] <i>Clockwise</i> . If both directions are selected, running in counterclockwise direction cannot be selected from the LCP.
[0] *	Clockwise	
[1]	Counter-clockwise	
[2]	Both directions	

4-11 Motor Speed Low Limit [RPM]		
Range:	Function:	
Size related*	[0 - par. 4-13 RPM]	Enter the minimum limit for motor speed in RPM. The motor speed low limit can be set to correspond to the minimum motor speed recommended by the manufacturer. The motor speed low limit must not exceed the setting in <i>parameter 4-13 Motor Speed High Limit [RPM]</i> .

4-12 Motor Speed Low Limit [Hz]		
Range:	Function:	
Size related*	[0 - par. 4-14 Hz]	Enter the minimum limit for motor speed in Hz. The motor speed low limit can be set to correspond to the minimum output frequency of the motor shaft. The speed low limit must not exceed the setting in <i>parameter 4-14 Motor Speed High Limit [Hz]</i> .

4-13 Motor Speed High Limit [RPM]		
Range:	Function:	
Size related*	[0 - 60000 RPM]	<p>NOTICE!</p> <p>Any changes in <i>parameter 4-13 Motor Speed High Limit [RPM]</i> reset the value in <i>parameter 4-53 Warning Speed High</i> to the value set in <i>parameter 4-13 Motor Speed High Limit [RPM]</i>.</p> <p>NOTICE!</p> <p>Maximum output frequency cannot exceed 10% of the inverter switching frequency (<i>parameter 14-01 Switching Frequency</i>).</p> <p>Enter the maximum limit for motor speed in RPM. The motor speed high limit can be set to correspond to the manufacturer's maximum rated motor. The motor speed high limit must exceed the setting in <i>parameter 4-11 Motor Speed Low Limit [RPM]</i>.</p> <p>The parameter name appears as either <i>parameter 4-11 Motor Speed Low Limit [RPM]</i> or <i>parameter 4-12 Motor Speed Low Limit [Hz]</i>, depending on:</p> <ul style="list-style-type: none"> The settings of other parameters in the <i>Main Menu</i>. Default settings based on geographical location.

4-14 Motor Speed High Limit [Hz]		
Range:	Function:	
Size related*	[.1 - par. 4-19 Hz]	Enter the maximum limit for motor speed in Hz. <i>Parameter 4-14 Motor Speed High Limit [Hz]</i> can be set to correspond to the manufacturer's recommended maximum motor speed. The motor speed high limit must exceed the value in <i>parameter 4-12 Motor Speed Low Limit [Hz]</i> . The output frequency must not exceed 10% of the switching frequency (<i>parameter 14-01 Switching Frequency</i>).

4-16 Torque Limit Motor Mode		
Range:	Function:	
Size related* [0 - 1000.0 %]	Enter the maximum torque limit for motor operation. The torque limit is active in the speed range up to and including the nominal motor speed set in <i>parameter 1-25 Motor Nominal Speed</i> . To protect the motor from reaching the stalling torque, the default setting is 1.1 x the rated motor torque (calculated value). See also <i>parameter 14-25 Trip Delay at Torque Limit</i> for further details. If a setting in <i>parameter 1-00 Configuration Mode</i> to <i>parameter 1-28 Motor Rotation Check</i> is changed, <i>parameter 4-16 Torque Limit Motor Mode</i> is not automatically reset to the default setting.	

4-17 Torque Limit Generator Mode		
Range:	Function:	
100 %* [0 - 1000.0 %]	Enter the maximum torque limit for generator-mode operation. The torque limit is active in the speed range up to and including the nominal motor speed (<i>parameter 1-25 Motor Nominal Speed</i>). Refer to <i>parameter 14-25 Trip Delay at Torque Limit</i> for further details. If a setting in <i>parameter 1-00 Configuration Mode</i> to <i>parameter 1-28 Motor Rotation Check</i> is changed, <i>parameter 4-17 Torque Limit Generator Mode</i> is not automatically reset to the default settings.	

4-18 Current Limit		
Range:	Function:	
160.0 %* [1.0 - 1000.0 %]	Enter the current limit for motor and generator operation. To protect the motor from reaching the stalling torque, the default setting is 1.1 x the rated motor torque (calculated value). If a setting in <i>parameter 1-00 Configuration Mode</i> to <i>parameter 1-26 Motor Cont. Rated Torque</i> is changed, <i>parameter 4-18 Current Limit</i> is not automatically reset to the default setting.	

4-19 Max Output Frequency		
Range:	Function:	
Size related* [1 - 590 Hz]	NOTICE! This parameter cannot be adjusted while the motor is running.	

4-19 Max Output Frequency		
Range:	Function:	
	NOTICE! When <i>parameter 1-10 Motor Construction</i> is set to [1] PM, non-salient SPM, the maximum value is limited to 300 Hz. Enter the maximum output frequency value. <i>Parameter 4-19 Max Output Frequency</i> specifies the absolute limit on the frequency converter output frequency for improved safety in applications where unintended overspeeding must be avoided. This absolute limit applies to all configurations and is independent of the setting in <i>parameter 1-00 Configuration Mode</i> .	

3.6.2 4-5* Adj. Warnings

Define adjustable warning limits for current, speed, reference, and feedback.

NOTICE!

Not visible in the display, only in MCT 10 Set-up Software.

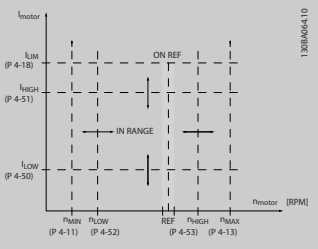
4-50 Warning Current Low		
Range:	Function:	
0 A* par. 4-51 A]	Warnings are shown on the display, programmed output, or fieldbus. 	
	<p>Figure 3.27 Low Current Limit</p> <p>Enter the I_{LOW} value. When the motor current drops below this limit (I_{LOW}), the display reads <i>Current low</i>. The signal outputs can be programmed to produce a status signal on terminal 27 or 29, and on relay output 01 or 02. Refer to <i>Figure 3.27</i>.</p>	

4-51 Warning Current High		
Range:		Function:
Size related*	[par. 4-50 - par. 16-37 A]	Enter the I_{HIGH} value. When the motor current exceeds this limit (I_{HIGH}), the display reads <i>Current high</i> . The signal outputs can be programmed to produce a status signal on terminal 27 or 29, and on relay output 01 or 02. Refer to <i>Figure 3.27</i> .

4-52 Warning Speed Low		
Range:		Function:
0 RPM*	[0 - par. 4-53 RPM]	Enter the n_{LOW} value. When the motor speed drops below this limit (n_{LOW}), the display reads <i>Speed Low</i> . The signal outputs can be programmed to produce a status signal on terminal 27 or 29, and on relay output 01 or 02. Program the lower signal limit of the motor speed, n_{LOW} , within the normal working range of the frequency converter. Refer to <i>Figure 3.27</i> .

4-53 Warning Speed High		
Range:		Function:
Size related*	[par. 4-52 - par. 4-13 RPM]	<p>NOTICE!</p> <p>Any changes in <i>parameter 4-13 Motor Speed High Limit [RPM]</i> reset the value in <i>parameter 4-53 Warning Speed High</i> to the same value as set in <i>parameter 4-13 Motor Speed High Limit [RPM]</i>.</p> <p>If a different value is needed in <i>parameter 4-53 Warning Speed High</i>, it must be set after programming of <i>parameter 4-13 Motor Speed High Limit [RPM]</i>.</p> <p>Enter the n_{HIGH} value. When the motor speed exceeds this limit (n_{HIGH}), the display reads <i>Speed high</i>. The signal outputs can be programmed to produce a status signal on terminal 27 or 29, and on relay output 01 or 02. Program the upper signal limit of the motor speed, n_{HIGH}, within the normal working range of the frequency converter. Refer to <i>Figure 3.27</i>.</p>

4-54 Warning Reference Low		
Range:		Function:
-999999.999*	[-999999.999 - par. 4-55]	Enter the lower reference limit. When the actual reference drops below this limit, the display indicates Ref_{Low} . The signal outputs can be programmed to produce a status signal on terminal 27 or 29, and on relay output 01 or 02.

4-55 Warning Reference High		
Range:		Function:
999999.999*	[par. 4-54 - 999999.999]	Enter the upper reference limit. When the actual reference exceeds this limit, the display reads Ref_{High} . The signal outputs can be programmed to produce a status signal on terminal 27 or 29, and on relay output 01 or 02.

4-56 Warning Feedback Low		
Range:		Function:
-999999.999 ReferenceFeed-backUnit*	[-999999.999 - par. 4-57 ReferenceFeed-backUnit]	Enter the lower feedback limit. When the feedback drops below this limit, the display reads $Feedb_{Low}$. The signal outputs can be programmed to produce a status signal on terminal 27 or 29, and on relay output 01 or 02.

4-57 Warning Feedback High		
Range:		Function:
999999.999 ReferenceFeed-backUnit*	[par. 4-56 - 999999.999 ReferenceFeed-backUnit]	Enter the upper feedback limit. When the feedback exceeds this limit, the display reads $Feedb_{High}$. The signal outputs can be programmed to produce a status signal on terminal 27 or 29, and on relay output 01 or 02.

4-58 Missing Motor Phase Function	
Option: Function:	
	<p>NOTICE!</p> <p>This parameter cannot be adjusted while the motor is running.</p> <p>Shows an alarm if a motor phase is missing.</p>
[0] *	No alarm is shown if a missing motor phase occurs.
[1]	An alarm is shown if a missing motor phase occurs.
[2]	

3.6.3 4-6* Speed Bypass

Some systems require that certain output frequencies or speeds are avoided due to resonance problems in the system. A maximum of 4 frequency or speed ranges can be avoided.

4-60 Bypass Speed From [RPM]		
Array [4]		
Range:		Function:
Size related*	[0 - par. 4-13 RPM]	Some systems require that certain output frequencies or speeds are avoided due to resonance problems in the system. Enter the lower limits of the speeds to be avoided.

4-61 Bypass Speed From [Hz]		
Array [4]		
Range:		Function:
Size related*	[0 - par. 4-14 Hz]	Some systems require that certain output frequencies or speeds are avoided due to resonance problems in the system. Enter the lower limits of the speeds to be avoided.

4-62 Bypass Speed To [RPM]		
Array [4]		
Range:		Function:
Size related*	[0 - par. 4-13 RPM]	Some systems require that certain output frequencies or speeds are avoided due to resonance problems in the system. Enter the upper limits of the speeds to be avoided.

4-63 Bypass Speed To [Hz]		
Array [4]		
Range:		Function:
Size related*	[0 - par. 4-14 Hz]	Some systems require that certain output frequencies or speeds are avoided due to resonance problems in the system. Enter the upper limits of the speeds to be avoided.

3.6.4 Semi-Automatic Bypass Speed Set-up

Use the semi-automatic bypass speed set-up to facilitate the programming of the frequencies to be skipped due to resonances in the system.

Carry out the following process:

1. Stop the motor.
2. Select [1] Enabled in parameter 4-64 Semi-Auto Bypass Set-up.
3. Press [Hand On] on the LCP to start the search for frequency bands causing resonances. The motor ramps up according to the ramp set.
4. When sweeping through a resonance band, press [OK] on the LCP when leaving the band. The actual frequency is stored as the first element in parameter 4-62 Bypass Speed To [RPM] or parameter 4-63 Bypass Speed To [Hz] (array). Repeat this step for each resonance band identified at the ramp-up (maximum 4 can be adjusted).
5. When maximum speed has been reached, the motor automatically begins to ramp down. Repeat the above procedure when speed is leaving the resonance bands during the deceleration. The actual frequencies registered when pressing [OK] are stored in parameter 4-60 Bypass Speed From [RPM] or parameter 4-61 Bypass Speed From [Hz].
6. When the motor has ramped down to stop, press [OK]. Parameter 4-64 Semi-Auto Bypass Set-up automatically resets to Off. The frequency converter stays in hand-on mode until [Off] or [Auto On] is pressed on the LCP.

3

If the frequencies for a certain resonance band are not registered in the right order, all registrations are canceled and the following message is shown: *Collected speed areas overlapping or not completely determined. Press [Cancel] to abort.* Registration in wrong order is when frequency values stored in *parameter 4-62 Bypass Speed To [RPM]* are higher than the values in *parameter 4-60 Bypass Speed From [RPM]*, or if they do not have the same numbers of registrations for the *Bypass From* and *Bypass To*.

4-64 Semi-Auto Bypass Set-up		
Option:	Function:	
[0] *	Off	No function.
[1]	Enabled	Starts the semi-automatic bypass set-up and continues with the procedure described in <i>chapter 3.6.4 Semi-Automatic Bypass Speed Set-up.</i>

3.7 Parameters 5-** Digital In/Out

Parameter group for configuring the digital input and output.

3.7.1 5-0* Digital I/O Mode

Parameters for configuring the input and output using NPN and PNP.

5-00 Digital I/O Mode		
Option:	Function:	
		<p>NOTICE! This parameter cannot be adjusted while the motor is running.</p> <p>Digital inputs and programmed digital outputs are pre-programmable for operation either in PNP or NPN systems.</p>
[0] *	PNP - Active at 24V	Action on positive directional pulses (0). PNP systems are pulled down to GND.
[1]	NPN - Active at 0V	Action on negative directional pulses (1). NPN systems are pulled up to +24 V, internally in the frequency converter.

5-01 Terminal 27 Mode		
Option:	Function:	
		<p>NOTICE! This parameter cannot be adjusted while the motor is running.</p>
[0] *	Input	Defines terminal 27 as a digital input.
[1]	Output	Defines terminal 27 as a digital output.

5-02 Terminal 29 Mode		
Option:	Function:	
		<p>NOTICE! This parameter cannot be adjusted while the motor is running.</p>
[0] *	Input	Defines terminal 29 as a digital input.
[1]	Output	Defines terminal 29 as a digital output.

3.7.2 5-1* Digital Inputs

Parameters for configuring the input functions for the input terminals.

The digital inputs are used for selecting various functions in the frequency converter. All digital inputs can be set to the following functions:

Options [120]–[138] are related to the cascade controller functionality. For more information, see *parameter group 25-** Cascade Controller*.

Digital input function	Option	Terminal
No operation	[0]	19, 29, 32, 33
Reset	[1]	All
Coast inverse	[2]	27
Coast and reset inverse	[3]	All
DC-brake inverse	[5]	All
Stop inverse	[6]	All
External interlock	[7]	All
Start	[8]	All
Latched start	[9]	All
Reversing	[10]	All
Start reversing	[11]	All
Jog	[14]	All
Preset reference on	[15]	All
Preset ref bit 0	[16]	All
Preset ref bit 1	[17]	All
Preset ref bit 2	[18]	All
Freeze reference	[19]	All
Freeze output	[20]	All
Speed up	[21]	All
Speed down	[22]	All
Set-up select bit 0	[23]	All
Set-up select bit 1	[24]	All
Pulse input	[32]	29, 33
Ramp bit 0	[34]	All
Mains failure inverse	[36]	All
Ref source bit 0	[42]	All
Hand/auto start	[51]	All
Run permissive	[52]	All
Hand start	[53]	All
Auto start	[54]	All
DigiPot increase	[55]	All
DigiPot decrease	[56]	All
DigiPot clear	[57]	All
Counter A (up)	[60]	29, 33
Counter A (down)	[61]	29, 33
Reset counter A	[62]	All
Counter B (up)	[63]	29, 33
Counter B (down)	[64]	29, 33
Reset counter B	[65]	All
Sleep mode	[66]	All
Reset maintenance word	[78]	All
PTC card 1	[80]	All

Digital input function	Option	Terminal
Latched pump derag	[85]	All
Lead pump start	[120]	All
Lead pump alternation	[121]	All
Pump 1 interlock	[130]	All
Pump 2 interlock	[131]	All
Pump 3 interlock	[132]	All

Table 3.12 Functions for Digital Inputs

All stands for terminals 18, 19, 27, 29, 32, X30/2, X30/3, and X30/4.

X30/X are the terminals on VLT® General Purpose I/O MCB 101.

Functions dedicated to only 1 digital input are stated in the associated parameter.

All digital inputs can be programmed to these functions:

[0]	No operation	No reaction to signals transmitted to terminal.
[1]	Reset	Resets the frequency converter after a trip/ alarm. Not all alarms can be reset.
[2]	Coast inverse	Leaves motor in free mode. Logic 0=coast stop. (Default digital input 27) Coast stop, inverted input (NC).
[3]	Coast and reset inverse	Reset and coast stop inverted input (NC). Leaves motor in free mode and resets the frequency converter. Logic 0=coast stop and reset.
[5]	DC-brake inverse	Inverted input for DC brake (NC). Stops motor by energizing it with a DC current for a certain time period. See <i>parameter 2-01 DC Brake Current</i> to <i>parameter 2-03 DC Brake Cut In Speed [RPM]</i> . The function is only active when the value in <i>parameter 2-02 DC Braking Time</i> is different from 0. Logic 0=DC brake. This selection is not possible when <i>parameter 1-10 Motor Construction</i> is set to [1] PM, non-salient SPM.
[6]	Stop inverse	Stop inverted function. Generates a stop function when the selected terminal goes from logical level 1 to 0. The stop is performed according to the selected ramp time (<i>parameter 3-42 Ramp 1 Ramp Down Time</i> and <i>parameter 3-52 Ramp 2 Ramp Down Time</i>).

NOTICE!

When the frequency converter is at the torque limit and has received a stop command, it may not stop by itself. To ensure that the frequency converter stops, configure a digital output to [27] *Torque limit & stop* and connect it to a digital input configured as coast.

[7]	External Interlock	Same function as coast stop inverse, but external interlock generates the alarm message <i>external fault</i> when the terminal programmed for coast inverse is logic 0. The alarm message is also active via digital outputs and relay outputs, if programmed for external interlock. The alarm can be reset using a digital input or the [Reset] key if the cause for the external interlock has been removed. A delay can be programmed in <i>parameter 22-00 External Interlock Delay</i> . After applying a signal to the input, the reaction is delayed with the time set in <i>parameter 22-00 External Interlock Delay</i> .
[8]	Start	Select start value for a start/stop command. 1=start, 0=stop. (Default digital input 18).
[9]	Latched start	The motor starts if a pulse is applied for minimum 2 ms. The motor stops when stop inverse is activated.
[10]	Reversing	Changes direction of motor shaft rotation. Select logic 1 to reverse. The reversing signal only changes the direction of rotation. It does not activate the start function. Select both directions in <i>parameter 4-10 Motor Speed Direction</i> . (Default digital input 19).
[11]	Start reversing	Used for start/stop and for reversing on the same wire. Signals on start are not allowed at the same time.
[14]	Jog	Used for activating jog speed. See <i>parameter 3-11 Jog Speed [Hz]</i> . (Default digital input 29).
[15]	Preset reference on	Used for shifting between external reference and preset reference. It is assumed that [1] <i>External/preset</i> has been selected in <i>parameter 3-04 Reference Function</i> . Logic 0 = external reference active; logic 1 = 1 of the 8 preset references is active.
[16]	Preset ref bit 0	Enables a selection of 1 of the 8 preset references according to <i>Table 3.13</i> .
[17]	Preset ref bit 1	Enables a selection of 1 of the 8 preset references according to <i>Table 3.13</i> .

[18]	Preset ref bit 2	Enables a selection of 1 of the 8 preset references according to <i>Table 3.13</i> .																																				
		<table border="1"> <thead> <tr> <th>Preset ref. bit</th> <th>2</th> <th>1</th> <th>0</th> </tr> </thead> <tbody> <tr> <td>Preset reference 0</td> <td>0</td> <td>0</td> <td>0</td> </tr> <tr> <td>Preset reference 1</td> <td>0</td> <td>0</td> <td>1</td> </tr> <tr> <td>Preset reference 2</td> <td>0</td> <td>1</td> <td>0</td> </tr> <tr> <td>Preset reference 3</td> <td>0</td> <td>1</td> <td>1</td> </tr> <tr> <td>Preset reference 4</td> <td>1</td> <td>0</td> <td>0</td> </tr> <tr> <td>Preset reference 5</td> <td>1</td> <td>0</td> <td>1</td> </tr> <tr> <td>Preset reference 6</td> <td>1</td> <td>1</td> <td>0</td> </tr> <tr> <td>Preset reference 7</td> <td>1</td> <td>1</td> <td>1</td> </tr> </tbody> </table>	Preset ref. bit	2	1	0	Preset reference 0	0	0	0	Preset reference 1	0	0	1	Preset reference 2	0	1	0	Preset reference 3	0	1	1	Preset reference 4	1	0	0	Preset reference 5	1	0	1	Preset reference 6	1	1	0	Preset reference 7	1	1	1
		Preset ref. bit	2	1	0																																	
		Preset reference 0	0	0	0																																	
		Preset reference 1	0	0	1																																	
		Preset reference 2	0	1	0																																	
		Preset reference 3	0	1	1																																	
		Preset reference 4	1	0	0																																	
		Preset reference 5	1	0	1																																	
		Preset reference 6	1	1	0																																	
Preset reference 7	1	1	1																																			
Table 3.13 Preset Reference Bit																																						
[19]	Freeze ref	Freezes the actual reference. The frozen reference is now the point of enable/condition for speed up and speed down to be used. If speed up/speed down is used, the speed change always follows ramp 2 (<i>parameter 3-51 Ramp 2 Ramp Up Time</i> and <i>parameter 3-52 Ramp 2 Ramp Down Time</i>) in the range 0– <i>parameter 3-03 Maximum Reference</i> .																																				
[20]	Freeze output	Freezes the actual motor frequency (Hz). The frozen motor frequency is now the point of enable/condition for speed up and speed down to be used. If speed up/speed down is used, the speed change always follows ramp 2 (<i>parameter 3-51 Ramp 2 Ramp Up Time</i> and <i>parameter 3-52 Ramp 2 Ramp Down Time</i>) in the range 0– <i>parameter 1-23 Motor Frequency</i> . NOTICE! When [20] Freeze output is active, the frequency converter cannot be stopped via a low [13] Start signal. Stop the frequency converter via a terminal programmed for [2] Coast inverse or [3] Coast and reset, inverse.																																				
[21]	Speed up	For digital control of the speed up/speed down (motor potentiometer). Activate this function by selecting either [19] Freeze reference or [20] Freeze output. When [21] Speed up is activated for less than 400 ms, the resulting reference is increased by 0.1%. If [21] Speed up is activated for more than 400 ms, the resulting reference ramps according to ramp 1 in <i>parameter 3-41 Ramp 1 Ramp Up Time</i> .																																				
[22]	Speed down	Same as [21] Speed up.																																				
[23]	Set-up select bit 0	Selects 1 of the 4 set-ups. Set <i>parameter 0-10 Active Set-up</i> to Multi Set-up.																																				
[24]	Set-up select bit 1	Same as [23] Set-up select bit 0. (Default digital input 32).																																				

[32]	Pulse input	Select [32] Pulse input when using a pulse sequence as either reference or feedback. Scaling is done in <i>parameter group 5-5* Pulse Input</i> .
[34]	Ramp bit 0	Select which ramp to use. Logic 0 selects ramp 1 while logic 1 selects ramp 2.
[36]	Mains failure inverse	Activates <i>parameter 14-10 Mains Failure</i> . Mains failure inverse is active in the logic 0 situation.
[42]	Ref source bit 0	An active input in bit 0 selects AI54 as the reference source (see <i>parameter group 3-1* References</i> , option [35] Digital input select). An inactive input selects AI53.
[51]	Hand/Auto Start	Selects hand or auto start. High signal selects auto on only, Low signal selects hand on only.
[52]	Run Permissive	The input terminal, for which the [52] Run Permissive has been programmed, must be logic 1 before a start command can be accepted. Run permissive has a logic AND function related to the terminal, which is programmed for [8] Start, [14] Jog, or [20] Freeze Output. To start running the motor, both conditions must be fulfilled. If [52] Run Permissive is programmed on multiple terminals, it only has to be logic 1 on 1 of the terminals to carry out the function. The digital output signal for run request ([8] Start, [14] Jog, or [20] Freeze output) programmed in <i>parameter group 5-3* Digital Outputs</i> , or <i>parameter group 5-4* Relays</i> , is not affected by [52] Run Permissive.
[53]	Hand start	A signal applied puts the frequency converter into hand-on mode as if [Hand On] has been pressed and a normal stop command is overridden. If disconnecting the signal, the motor stops. To make any other start commands valid, assign another digital input to [54] Auto Start and apply a signal to this. [Hand On] and [Auto On] have no impact. [Off] overrides local start and auto start. Press either [Hand On] or [Auto On] to make local start and auto start active again. If there is no signal on neither [53] Hand start nor [54] Auto start, the motor stops regardless of any normal start command applied. If a signal is applied to both [53] Hand start and [54] Auto start, the function is auto start. If pressing [Off], the motor stops regardless of signals on [53] Hand start and [54] Auto start.
[54]	Auto start	A signal applied puts the frequency converter into auto-on mode as if [Auto On] has been pressed. See also [53] Hand Start.

[55]	DigiPot Increase	Uses the input as an increase signal to the digital potentiometer function described in <i>parameter group 3-9* Digital Pot.Meter</i> .
[56]	DigiPot Decrease	Uses the input as a decrease signal to the digital potentiometer function described in <i>parameter group 3-9* Digital Pot.Meter</i> .
[57]	DigiPot Clear	Uses the input to clear the digital potentiometer reference described in <i>parameter group 3-9* Digital Pot.Meter</i> .
[60]	Counter A (up)	(Terminal 29 or 33 only) Input for increment counting in the SLC counter.
[61]	Counter A (down)	(Terminal 29 or 33 only) Input for decrement counting in the SLC counter.
[62]	Reset Counter A	Input for reset of counter A.
[63]	Counter B (up)	(Terminal 29 and 33 only) Input for increment counting in the SLC counter.
[64]	Counter B (down)	(Terminal 29 and 33 only) Input for decrement counting in the SLC counter.
[65]	Reset Counter B	Input for reset of counter B.
[66]	Sleep Mode	Forces the frequency converter into sleep mode (see <i>parameter group 22-4* Sleep Mode</i>). Reacts on the rising edge of signal applied.
[78]	Reset Preventive Maintenance Word	Resets all data in <i>parameter 16-96 Maintenance Word</i> to 0.
[80]	PTC Card1	All digital inputs can be set to [80] PTC Card 1. However, only 1 digital input must be set to this option.
[85]	Latched Pump Derag	Starts deragging.

Options [120]–[138] are related to the cascade controller functionality. For more information, see *parameter group 25-** Cascade Controller*.

[120]	Lead Pump Start	Starts/stops the lead pump (controlled by the frequency converter). A start also requires applying a system start signal, for example to 1 of the digital inputs set for [8] Start.
[121]	Lead Pump Alternation	Forces alternation of the lead pump in a cascade controller. Set <i>parameter 25-50 Lead Pump Alternation</i> to either [2] At Command or [3] At Staging or At Command. <i>Parameter 25-51 Alternation Event</i> can be set to any of the 4 options.
[130] - [138]	Pump1 Interlock - Pump9 Interlock	The function depends on the setting in <i>parameter 25-06 Number of Pumps</i> . If set to [0] No, then Pump1 refers to the pump controlled by relay1 and so on. If set to [1]

	Yes, Pump1 refers to the pump controlled by the frequency converter only (without any of the built-in relays involved) and Pump2 to the pump controlled by relay1. Variable speed pump (lead) cannot be interlocked in the basic cascade controller. See Table 3.14.	
	Setting in <i>parameter group 5-1* Digital Inputs</i>	Setting in <i>parameter 25-06 Number of Pumps</i>
		[0] No [1] Yes
[130] Pump1 Interlock	Controlled by relay1 (only if not lead pump)	Controlled by frequency converter (cannot be interlocked)
[131] Pump2 Interlock	Controlled by relay2	Controlled by relay1
[132] Pump3 Interlock	Controlled by relay3	Controlled by relay2
[133] Pump4 Interlock	Controlled by relay4	Controlled by relay3
[134] Pump5 Interlock	Controlled by relay5	Controlled by relay4
[135] Pump6 Interlock	Controlled by relay6	Controlled by relay5
[136] Pump7 Interlock	Controlled by relay7	Controlled by relay6
[137] Pump8 Interlock	Controlled by relay8	Controlled by relay7
[138] Pump9 Interlock	Controlled by relay9	Controlled by relay8

5-10 Terminal 18 Digital Input

The parameter contains all options and functions listed in *parameter group 5-1* Digital Inputs* except for option [32] Pulse input.

5-11 Terminal 19 Digital Input

The parameter contains all options and functions listed in *parameter group 5-1* Digital Inputs* except for option [32] Pulse input.

5-12 Terminal 27 Digital Input

The parameter contains all options and functions listed in *parameter group 5-1* Digital Inputs* except for option [32] Pulse input.

5-13 Terminal 29 Digital Input

The parameter contains all options and functions listed in *parameter group 5-1* Digital Inputs*.

5-14 Terminal 32 Digital Input

The parameter contains all options and functions listed in *parameter group 5-1* Digital Inputs* except for option [32] Pulse input.

5-15 Terminal 33 Digital Input

The parameter contains all options and functions listed in *parameter group 5-1* Digital Inputs*.

5-16 Terminal X30/2 Digital Input

Option:		Function:
[0] *	No operation	This parameter is active when VLT® General Purpose I/O MCB 101 is installed in the frequency converter. The parameter contains all options and functions listed in <i>parameter group 5-1* Digital Inputs</i> except for option [32] Pulse input.

5-17 Terminal X30/3 Digital Input

Option:		Function:
[0] *	No operation	This parameter is active when VLT® General Purpose I/O MCB 101 is installed in the frequency converter. The parameter contains all options and functions listed in <i>parameter group 5-1* Digital Inputs</i> except for option [32] Pulse input.

5-18 Terminal X30/4 Digital Input

Option:		Function:
[0] *	No operation	This parameter is active when VLT® General Purpose I/O MCB 101 is installed in the frequency converter. The parameter contains all options and functions listed in <i>parameter group 5-1* Digital Inputs</i> except for option [32] Pulse input.

5-19 Terminal 37 Safe Stop

Use this parameter to configure the Safe Torque Off functionality. A warning message makes the frequency converter coast the motor and enables the automatic restart. An alarm message makes the frequency converter coast the motor and requires a manual restart (via a fieldbus, Digital I/O, or by pressing [RESET] on the LCP). When the VLT® PTC Thermistor Card MCB 112 is mounted, configure the PTC options to get the full benefit from the alarm handling.

Option:		Function:
[1] *		Coasts the frequency converter when Safe Torque Off is activated. Manual reset from LCP, digital input, or fieldbus.
[3]		Coasts the frequency converter when Safe Torque Off is activated (terminal 37 off). When the Safe Torque Off circuit is re-

5-19 Terminal 37 Safe Stop

Use this parameter to configure the Safe Torque Off functionality. A warning message makes the frequency converter coast the motor and enables the automatic restart. An alarm message makes the frequency converter coast the motor and requires a manual restart (via a fieldbus, Digital I/O, or by pressing [RESET] on the LCP). When the VLT® PTC Thermistor Card MCB 112 is mounted, configure the PTC options to get the full benefit from the alarm handling.

Option:		Function:
		established, the frequency converter continues without manual reset.
[4]		Coasts the frequency converter when Safe Torque Off is activated. Manual reset from LCP, digital input, or fieldbus.
[5]		Coasts the frequency converter when Safe Torque Off is activated (terminal 37 off). When the Safe Torque Off circuit is re-established, the frequency converter continues without manual reset, unless a digital input set to [80] PTC Card 1 is still enabled.
[6]		This option is used when the VLT® PTC Thermistor Card MCB 112 gates with a stop key through a safety relay to terminal 37. Coasts the frequency converter when Safe Torque Off is activated. Manual reset from LCP, digital input, or fieldbus.
[7]		This option is used when the VLT® PTC Thermistor Card MCB 112 gates with a stop key through a safety relay to terminal 37. Coasts the frequency converter when Safe Torque Off is activated (terminal 37 off). When the Safe Torque Off circuit is re-established, the frequency converter continues without manual reset, unless a digital input set to [80] PTC Card 1 is still enabled.
[8]		This option makes it possible to use a combination of alarm and warning.
[9]		This option makes it possible to use a combination of alarm and warning.

NOTICE!

Options [4] PTC 1 Alarm to [9] PTC 1 & Relay W/A are only available when the MCB 112 is connected.

NOTICE!

Selecting *Auto Reset/Warning* enables automatic restart of the frequency converter.

Function	Num-ber	PTC	Relay
No Function	[0]	–	–
Safe Torque Off Alarm	[1]*	–	Safe Torque Off [A68]
Safe Torque Off Warning	[3]	–	Safe Torque Off [W68]
PTC 1 Alarm	[4]	PTC 1 Safe Torque Off [A71]	–
PTC 1 Warning	[5]	PTC 1 Safe Torque Off [W71]	–
PTC 1 & Relay A	[6]	PTC 1 Safe Torque Off [A71]	Safe Torque Off [A68]
PTC 1 & Relay W	[7]	PTC 1 Safe Torque Off [W71]	Safe Torque Off [W68]
PTC 1 & Relay A/W	[8]	PTC 1 Safe Torque Off [A71]	Safe Torque Off [W68]
PTC 1 & Relay W/A	[9]	PTC 1 Safe Torque Off [W71]	Safe Torque Off [A68]

Table 3.14 Overview of Functions, Alarms, and Warnings

W means warning and *A* means alarm. For further information, see *Alarms and Warnings* in chapter 5 Troubleshooting.

A dangerous failure related to Safe Torque Off issues *alarm 72, Dangerous failure*.

Refer to Table 5.1.

5-20 Terminal X46/1 Digital Input

This parameter is related to the digital input on VLT® Extended Relay Card MCB 113. The parameter contains all options and functions listed in *parameter group 5-1* Digital Inputs* except for option [32] Pulse input.

5-21 Terminal X46/3 Digital Input

This parameter is related to the digital input on VLT® Extended Relay Card MCB 113. The parameter contains all options and functions listed in *parameter group 5-1* Digital Inputs* except for option [32] Pulse input.

5-22 Terminal X46/5 Digital Input

This parameter is related to the digital input on VLT® Extended Relay Card MCB 113. The parameter contains all options and functions listed in *parameter group 5-1* Digital Inputs* except for option [32] Pulse input.

5-23 Terminal X46/7 Digital Input

This parameter is related to the digital input on VLT® Extended Relay Card MCB 113. The parameter contains all options and functions listed in *parameter group 5-1* Digital Inputs* except for option [32] Pulse input.

5-24 Terminal X46/9 Digital Input

This parameter is related to the digital input on VLT® Extended Relay Card MCB 113. The parameter contains all options and functions listed in *parameter group 5-1* Digital Inputs* except for option [32] Pulse input.

5-25 Terminal X46/11 Digital Input

This parameter is related to the digital input on VLT® Extended Relay Card MCB 113. The parameter contains all options and functions listed in *parameter group 5-1* Digital Inputs* except for option [32] Pulse input.

5-26 Terminal X46/13 Digital Input

This parameter is related to the digital input on VLT® Extended Relay Card MCB 113. The parameter contains all options and functions listed in *parameter group 5-1* Digital Inputs* except for option [32] Pulse input.

3.7.3 5-3* Digital Outputs

Parameters for configuring the output functions for the output terminals. The 2 solid-state digital outputs are common for terminals 27 and 29. Set the I/O function for terminal 27 in *parameter 5-01 Terminal 27 Mode* and set the I/O function for terminal 29 in *parameter 5-02 Terminal 29 Mode*.

NOTICE!

These parameters cannot be adjusted while the motor is running.

		The digital outputs can be programmed with these functions:
[0]	No operation	Default for all digital outputs and relay outputs.
[1]	Control ready	The control board receives supply voltage.
[2]	Drive ready	The frequency converter is ready for operation and applies a supply signal on the control board.

[3]	Drive ready/ remote control	The frequency converter is ready for operation and is in auto-on mode.
[4]	Standby/no warning	The frequency converter is ready for operation. No start or stop command has been given (start/disable). There are no warnings.
[5]	Running	Motor is running.
[6]	Running/no warning	The output speed is higher than the speed set in <i>parameter 1-81 Min Speed for Function at Stop [RPM]</i> . The motor is running and there are no warnings.
[8]	Run on reference/no warning	Motor runs at reference speed.
[9]	Alarm	An alarm activates the output. There are no warnings.
[10]	Alarm or warning	An alarm or a warning activates the output.
[11]	At torque limit	The torque limit set in <i>parameter 4-16 Torque Limit Motor Mode</i> has been exceeded.
[12]	Out of current range	The motor current is outside the range set in <i>parameter 4-18 Current Limit</i> .
[13]	Below current, low	Motor current is lower than the setting in <i>parameter 4-50 Warning Current Low</i> .
[14]	Above current, high	Motor current is higher than the setting in <i>parameter 4-51 Warning Current High</i> .
[15]	Out of speed range	Output speed is outside the ranges set in <i>parameter 4-52 Warning Speed Low</i> and <i>parameter 4-53 Warning Speed High</i> .
[16]	Below speed, low	Output speed is lower than the setting in <i>parameter 4-52 Warning Speed Low</i> .
[17]	Above speed, high	Output speed is higher than the setting in <i>parameter 4-53 Warning Speed High</i> .
[18]	Out of feedback and range	Feedback is outside the ranges set in <i>parameter 4-56 Warning Feedback Low</i> and <i>parameter 4-57 Warning Feedback High</i> .
[19]	Below feedback low	Feedback is below the limit set in <i>parameter 4-52 Warning Speed Low</i> .
[20]	Above feedback high	The feedback is above the limit set in <i>parameter 4-56 Warning Feedback Low</i> .
[21]	Thermal warning	The thermal warning turns on when the temperature exceeds the limit in the motor, the frequency converter, the brake resistor, or the thermistor.
[25]	Reverse	Reversing. Logic 1 = relay activated, 24 V DC when clockwise rotation of the motor. Logic 0 = relay not activated, no signal, when counterclockwise rotation of the motor.
[26]	Bus OK	Active communication (no timeout) via the serial communication port.

[27]	Torque limit and stop	Used in performing a coast stop and in torque limit condition. If the frequency converter has received a stop signal and is at the torque limit, the signal is logic 0.
[28]	Brake, no warning	The brake is active and there are no warnings.
[29]	Brake ready, no fault	The brake is ready for operation and there are no faults.
[30]	Brake fault (IGBT)	The output is logic 1 when the brake IGBT is short-circuited. Use this function to protect the frequency converter if there is a fault on the brake modules. Use the output/relay to cut out the mains voltage from the frequency converter.
[35]	External Interlock	External interlock function has been activated via 1 of the digital inputs.
[40]	Out of ref range	
[41]	Below reference low	
[42]	Above reference high	
[45]	Bus Ctrl	
[46]	Bus Ctrl 1 if timeout	
[47]	Bus Ctrl 0 if timeout	
[55]	Pulse output	
[60]	Comparator 0	See <i>parameter group 13-1* Comparators</i> . If comparator 0 is evaluated as true, the output goes high. Otherwise, it is low.
[61]	Comparator 1	See <i>parameter group 13-1* Comparators</i> . If comparator 1 is evaluated as true, the output goes high. Otherwise, it is low.
[62]	Comparator 2	See <i>parameter group 13-1* Comparators</i> . If comparator 2 is evaluated as true, the output goes high. Otherwise, it is low.
[63]	Comparator 3	See <i>parameter group 13-1* Comparators</i> . If comparator 3 is evaluated as true, the output goes high. Otherwise, it is low.
[64]	Comparator 4	See <i>parameter group 13-1* Comparators</i> . If comparator 4 is evaluated as true, the output goes high. Otherwise, it is low.
[65]	Comparator 5	See <i>parameter group 13-1* Comparators</i> . If comparator 5 is evaluated as true, the output goes high. Otherwise, it is low.
[70]	Logic Rule 0	See <i>parameter group 13-4* Logic Rules</i> . If logic rule 0 is evaluated as true, the output goes high. Otherwise, it is low.
[71]	Logic Rule 1	See <i>parameter group 13-4* Logic Rules</i> . If logic rule 1 is evaluated as true, the output goes high. Otherwise, it is low.

[72]	Logic Rule 2	See <i>parameter group 13-4* Logic Rules</i> . If logic rule 2 is evaluated as true, the output goes high. Otherwise, it is low.	[161]	Running reverse	The output is high when the frequency converter is running counterclockwise (the logical product of the status bits running AND reverse).
[73]	Logic Rule 3	See <i>parameter group 13-4* Logic Rules</i> . If logic rule 3 is evaluated as true, the output goes high. Otherwise, it is low.	[165]	Local reference active	Output is high when <i>parameter 3-13 Reference Site</i> =[2] Local or when <i>parameter 3-13 Reference Site</i> =[0] Linked to hand auto at the same time as the LCP is in hand-on mode.
[74]	Logic Rule 4	See <i>parameter group 13-4* Logic Rules</i> . If logic rule 4 is evaluated as true, the output goes high. Otherwise, it is low.	[166]	Remote reference active	Output is high when <i>parameter 3-13 Reference Site</i> is set to [1] Remote or [0] Linked to hand/auto while the LCP is in auto-on mode.
[75]	Logic Rule 5	See <i>parameter group 13-4* Logic Rules</i> . If logic rule 5 is evaluated as true, the output goes high. Otherwise, it is low.	[167]	start command active	Output is high when there is an active start command, for example auto on, and a start command via digital input or bus is active, or [Hand On]. NOTICE! All inverse stop/coast commands must be inactive.
[80]	SL Digital Output A	See <i>parameter 13-52 SL Controller Action</i> . The output goes high whenever the smart logic action [38] Set digital out A high is executed. The output goes low whenever the smart logic action [32] Set digital out A low is executed.	[168]	Drive in hand mode	Output is high when the frequency converter is in hand-on mode (as indicated by the indicator light above [Hand On]).
[81]	SL Digital Output B	See <i>parameter 13-52 SL Controller Action</i> . The output goes high whenever the smart logic action [39] Set digital out B high is executed. The output goes low whenever the smart logic action [33] Set digital out B low is executed.	[169]	Drive in auto mode	Output is high when the frequency converter is in auto-on mode (as indicated by the indicator light above [Auto On]).
[82]	SL Digital Output C	See <i>parameter 13-52 SL Controller Action</i> . The output goes high whenever the smart logic action [40] Set digital out C high is executed. The output goes low whenever the smart logic action [34] Set digital out C low is executed.	[180]	Clock Fault	The clock function has been reset to default (2000-01-01) because of a power failure.
[83]	SL Digital Output D	See <i>parameter 13-52 SL Controller Action</i> . The output goes high whenever the smart logic action [41] Set digital out D high is executed. The output goes low whenever the smart logic action [35] Set digital out D low is executed.	[181]	Preventive Maintenance	One or more of the preventive maintenance events programmed in <i>parameter 23-10 Maintenance Item</i> has passed the time for the specified action in <i>parameter 23-11 Maintenance Action</i> .
[84]	SL Digital Output E	See <i>parameter 13-52 SL Controller Action</i> . The output goes high whenever the smart logic action [42] Set digital out E high is executed. The output goes low whenever the smart logic action [36] Set digital out E low is executed.	[182]	Deragging	Deragging is active.
[85]	SL Digital Output F	See <i>parameter 13-52 SL Controller Action</i> . The output goes high whenever the smart logic action [43] Set digital out F high is executed. The output goes low whenever the smart logic action [37] Set digital out F low is executed.	[188]	AHF Capacitor Connect	See <i>parameter 5-80 AHF Cap Reconnect Delay</i> .
[90]	kWh counter pulse	Creates a pulse on the digital output every time the frequency converter uses 1 kWh.	[189]	External Fan Control	External fan control is active.
[120]	System On Ref		[190]	No-Flow	A no-flow situation or minimum speed situation has been detected if enabled in <i>Parameter 22-21 Low Power Detection</i> .
[155]	Verifying Flow		[191]	Dry Pump	A dry-pump condition has been detected. Enable this function in <i>parameter 22-26 Dry Pump Function</i> .
[160]	No alarm	Output is high when no alarm is present.	[192]	End of Curve	Active when an end-of-curve condition is present.
			[193]	Sleep Mode	The frequency converter/system has entered sleep mode. See <i>parameter group 22-4* Sleep Mode</i> .
			[194]	Broken Belt	A broken-belt condition has been detected. Enable this function in <i>parameter 22-60 Broken Belt Function</i> .

[195]	Bypass Valve Control	<p>The bypass valve control (digital/relay output in the frequency converter) is used for compressor systems to unload the compressor during start-up by using a bypass valve. After the start command is given, the bypass valve is open until the frequency converter reaches <i>parameter 4-11 Motor Speed Low Limit [RPM]</i>. After the limit has been reached, the bypass valve is closed, allowing the compressor to operate normally. This procedure is not activated again before a new start is initiated and the frequency converter speed is 0 during the receiving of start signal. <i>Parameter 1-71 Start Delay</i> can be used to delay the motor start.</p> <p>Figure 3.28 Bypass Valve Control Principle</p>
[199]	Pipe Filling	Active when the pipe fill function is operating. See <i>parameter group 29-** Water Application Functions</i> .

		The below setting options are all related to the cascade controller. See <i>parameter group 25-** Cascade Controller</i> for more details.
[200]	Full Capacity	All pumps running at full speed.
[201]	Pump1 Running	One or more of the pumps controlled by the cascade controller are running. The function also depends on the setting in <i>parameter 25-05 Fixed Lead Pump</i> . If set to [0] No, Pump 1 refers to the pump controlled by relay1, and so on. If set to [1] Yes, Pump 1 refers to the pump controlled by the frequency converter only (without any of the built-in relays involved) and Pump 2 to the pump controlled by relay1. See <i>Table 3.15</i> .
[202]	Pump2 Running	See [201].
[203]	Pump3 Running	See [201].
[204]	Pump 4 running	

[205]	Pump 5 running	
[206]	Pump 6 running	
[207]	Pump 7 running	
[208]	Pump 8 running	
[209]	Pump 9 running	
[240]	RS Flipflop 0	See <i>parameter 13-15 RS-FF Operand S</i> , <i>parameter 13-16 RS-FF Operand R</i> .
[241]	RS Flipflop 1	See <i>parameter 13-15 RS-FF Operand S</i> , <i>parameter 13-16 RS-FF Operand R</i> .
[242]	RS Flipflop 2	See <i>parameter 13-15 RS-FF Operand S</i> , <i>parameter 13-16 RS-FF Operand R</i> .
[243]	RS Flipflop 3	See <i>parameter 13-15 RS-FF Operand S</i> , <i>parameter 13-16 RS-FF Operand R</i> .
[244]	RS Flipflop 4	See <i>parameter 13-15 RS-FF Operand S</i> , <i>parameter 13-16 RS-FF Operand R</i> .
[245]	RS Flipflop 5	See <i>parameter 13-15 RS-FF Operand S</i> , <i>parameter 13-16 RS-FF Operand R</i> .
[246]	RS Flipflop 6	See <i>parameter 13-15 RS-FF Operand S</i> , <i>parameter 13-16 RS-FF Operand R</i> .
[247]	RS Flipflop 7	See <i>parameter 13-15 RS-FF Operand S</i> , <i>parameter 13-16 RS-FF Operand R</i> .

Setting in <i>parameter group 5-3* Digital Outputs</i>	Setting in <i>parameter 25-05 Fixed Lead Pump</i>	
	[0] No	[1] Yes
[201] Pump 1 Running	Controlled by relay1	Controlled by frequency converter
[202] Pump 2 Running	Controlled by relay2	Controlled by relay1
[203] Pump 3 Running	–	Controlled by relay2

Table 3.15 Pumps Controlled by the Cascade Controller

5-30 Terminal 27 Digital Output

This parameter has the options described in *chapter 3.7.3 5-3* Digital Outputs*.

Option:	Function:
[0] *	No operation

5-31 Terminal 29 Digital Output

This parameter has the options described in *chapter 3.7.3 5-3* Digital Outputs*.

Option:	Function:
[0] *	No operation

5-32 Term X30/6 Digi Out (MCB 101)

This parameter has the options described in *chapter 3.7.3 5-3* Digital Outputs*.

Option: **Function:**

[0] *	No operation	This parameter is active when VLT® General Purpose I/O MCB 101 is mounted in the frequency converter.
-------	--------------	---

5-33 Term X30/7 Digi Out (MCB 101)

Option: **Function:**

[0] *	No operation	This parameter is active when VLT® General Purpose I/O MCB 101 is mounted in the frequency converter. Same options and functions as <i>parameter group 5-3* Digital Inputs</i> .
-------	--------------	--

3.7.4 5-4* Relays

Parameters for configuring the timing and the output functions for the relays.

5-40 Function Relay

Array [20]

Option: **Function:**

		Select options to define the function of the relays. The selection of each mechanical relay is realized in an array parameter.
[0] *	No operation	
[1]	Control ready	
[2]	Drive ready	
[3]	Drive rdy/rem ctrl	
[4]	Enable / no warning	
[5]	VLT running	
[6]	Running / no warning	
[7]	Run in range/no warn	
[8]	Run on ref/no warn	
[9]	Alarm	
[10]	Alarm or warning	
[11]	At torque limit	
[12]	Out of current range	
[13]	Below current, low	
[14]	Above current, high	
[15]	Out of speed range	
[16]	Below speed, low	
[17]	Above speed, high	
[18]	Out of feedb. range	
[19]	Below feedback, low	
[20]	Above feedback, high	
[21]	Thermal warning	

5-40 Function Relay

Array [20]

Option: **Function:**

[22]	Ready,no thermal W	
[23]	Remote,ready,no TW	
[24]	Ready, voltage OK	
[25]	Reverse	
[26]	Bus OK	
[27]	Torque limit stop	
[28]	Brake: No Brake War	
[29]	Brake ready, no fault	
[30]	Brake fault (IGBT)	
[31]	Relay 123	
[32]	Mech brake ctrl	
[33]	Safe stop active	
[36]	Control word bit 11	
[37]	Control word bit 12	
[40]	Out of ref range	
[41]	Below reference, low	
[42]	Above ref, high	
[45]	Bus ctrl.	
[46]	Bus ctrl, 1 if timeout	
[47]	Bus ctrl, 0 if timeout	
[51]	MCO controlled	
[60]	Comparator 0	
[61]	Comparator 1	
[62]	Comparator 2	
[63]	Comparator 3	
[64]	Comparator 4	
[65]	Comparator 5	
[70]	Logic rule 0	
[71]	Logic rule 1	
[72]	Logic rule 2	
[73]	Logic rule 3	
[74]	Logic rule 4	
[75]	Logic rule 5	
[80]	SL digital output A	
[81]	SL digital output B	
[82]	SL digital output C	
[83]	SL digital output D	
[84]	SL digital output E	
[85]	SL digital output F	
[120]	Local ref active	
[121]	Remote ref active	
[122]	No alarm	
[123]	Start command activ	
[124]	Running reverse	
[125]	Drive in hand mode	
[126]	Drive in auto mode	

5-41 On Delay, Relay		
Array [20]		
Range:	Function:	
0.01 s* [0.01 - 600 s]	Enter the delay of the relay cut-in time. Select 1 of 2 internal mechanical relays in an array function. See <i>parameter 5-40 Function Relay</i> for details.	

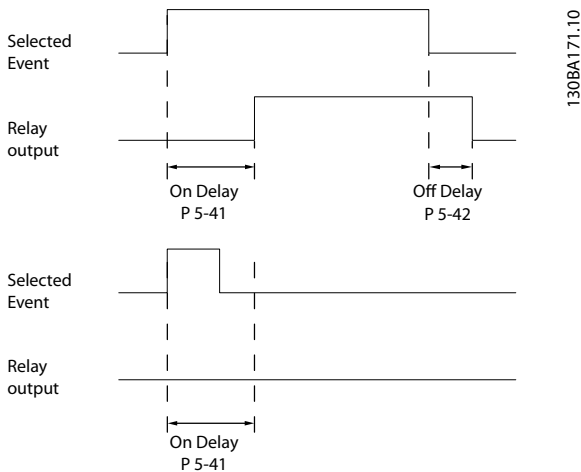

Figure 3.29 On Delay, Relay

3.7.5 5-5* Pulse Input

The pulse input parameters are used to define an appropriate window for the impulse reference area by configuring the scaling and filter settings for the pulse inputs. Input terminal 29 or 33 acts as frequency reference inputs. Set terminal 29 (*parameter 5-13 Terminal 29 Digital Input*) or terminal 33 (*parameter 5-15 Terminal 33 Digital Input*) to [32] Pulse input. If terminal 29 is used as an input, set *parameter 5-02 Terminal 29 Mode* to [0] Input.

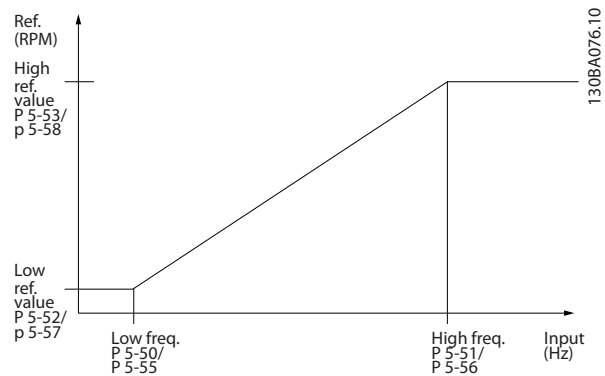

Figure 3.31 Pulse Input

5-42 Off Delay, Relay		
Array[20]		
Range:	Function:	
0.01 s* [0.01 - 600 s]	Enter the delay of the relay cutout time. Select 1 of 2 internal mechanical relays in an array function. See <i>parameter 5-40 Function Relay</i> for details. If the selected event condition changes before a delay timer expires, the relay output is unaffected.	

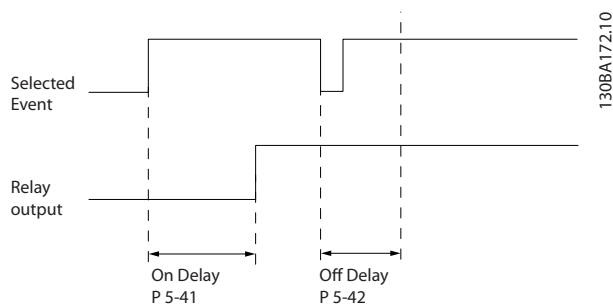

Figure 3.30 Off Delay, Relay

If the selected event condition changes before the on delay or off delay timer expires, the relay output is unaffected.

5-50 Term. 29 Low Frequency		
Range:	Function:	
100 Hz* [0 - 110000 Hz]	Enter the low frequency limit corresponding to the low motor shaft speed (that is low reference value) in <i>parameter 5-52 Term. 29 Low Ref./Feedb. Value</i> . Refer to <i>Figure 3.31</i> in this section.	

5-51 Term. 29 High Frequency		
Range:	Function:	
100 Hz* [0 - 110000 Hz]	Enter the high frequency limit corresponding to the high motor shaft speed (that is high reference value) in <i>parameter 5-53 Term. 29 High Ref./Feedb. Value</i> .	

5-52 Term. 29 Low Ref./Feedb. Value		
Range:	Function:	
0 ReferenceFeed-backUnit* [-999999.999 - 999999.999 ReferenceFeed-backUnit]	Enter the low reference value limit for the motor shaft speed [RPM]. This is also the lowest feedback value, see also <i>parameter 5-57 Term. 33 Low Ref./Feedb. Value</i> .	

5-53 Term. 29 High Ref./Feedb. Value		
Range:		Function:
100 Reference-FeedbackUnit*	[-999999.999 - 999999.999 ReferenceFeed-backUnit]	Enter the high reference value [RPM] for the motor shaft speed and the high feedback value, see also <i>parameter 5-58 Term. 33 High Ref./Feedb. Value.</i>

5-58 Term. 33 High Ref./Feedb. Value		
Range:		Function:
100 Reference-FeedbackUnit*	[-999999.999 - 999999.999 ReferenceFeed-backUnit]	Enter the high reference value [RPM] for the motor shaft speed. See also <i>parameter 5-53 Term. 29 High Ref./Feedb. Value.</i>

5-54 Pulse Filter Time Constant #29		
Range:		Function:
100 ms*	[5 - 1000 ms]	NOTICE! This parameter cannot be adjusted while the motor is running. Enter the pulse filter time constant. The pulse filter dampens oscillations of the feedback signal, which is an advantage if there is a lot of noise in the system. A high time constant value results in better dampening, but also increases the time delay through the filter.

5-59 Pulse Filter Time Constant #33		
Range:		Function:
100 ms*	[5 - 1000 ms]	NOTICE! This parameter cannot be adjusted while the motor is running. Enter the pulse filter time constant. The low-pass filter reduces the influence and dampens oscillations on the feedback signal from the control. This is an advantage if there is a lot of noise in the system.

5-55 Term. 33 Low Frequency		
Range:		Function:
100 Hz*	[0 - 110000 Hz]	Enter the low frequency corresponding to the low motor shaft speed (that is low reference value) in <i>parameter 5-57 Term. 33 Low Ref./Feedb. Value.</i>

5-56 Term. 33 High Frequency		
Range:		Function:
100 Hz*	[0 - 110000 Hz]	Enter the high frequency corresponding to the high motor shaft speed (that is high reference value) in <i>parameter 5-58 Term. 33 High Ref./Feedb. Value.</i>

5-57 Term. 33 Low Ref./Feedb. Value		
Range:		Function:
0 ReferenceFeed-backUnit*	[-999999.999 - 999999.999 ReferenceFeed-backUnit]	Enter the low reference value [RPM] for the motor shaft speed. This is also the low feedback value, see also <i>parameter 5-52 Term. 29 Low Ref./Feedb. Value.</i>

3.7.6 5-6* Pulse Outputs

Parameters for configuring the scaling and output functions of pulse outputs. The pulse outputs are designated to terminal 27 or 29. Select terminal 27 output in *parameter 5-01 Terminal 27 Mode* and terminal 29 output in *parameter 5-02 Terminal 29 Mode*.

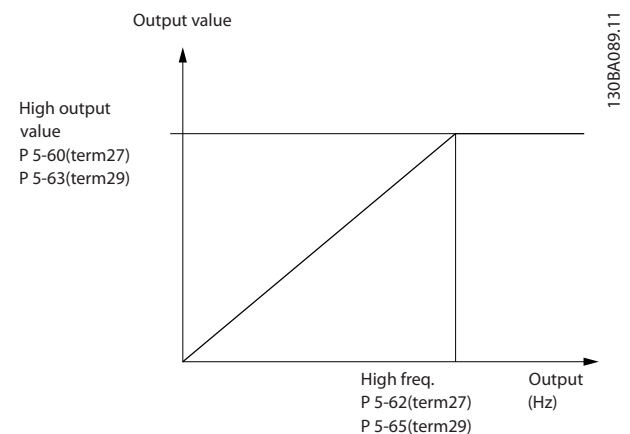

Figure 3.32 Pulse Output

5-60 Terminal 27 Pulse Output Variable		
Range:		Function:
		NOTICE! This parameter cannot be adjusted while the motor is running.
[0] *	No operation	Select the operation variable assigned for terminal 27 readouts.
[45]	Bus ctrl.	
[48]	Bus ctrl., timeout	
[51]	MCO controlled	
[100]	Output frequency	
[101]	Reference	
[102]	Feedback	
[103]	Motor current	
[104]	Torque rel to limit	
[105]	Torq relate to rated	
[106]	Power	
[107]	Speed	
[108]	Torque	
[109]		
[119]		

5-62 Pulse Output Max Freq #27		
Range:		Function:
		NOTICE! This parameter cannot be adjusted while the motor is running.
5000 Hz*	[0 - 32000 Hz]	Set the maximum frequency for terminal 27 corresponding to the output variable selected in <i>parameter 5-60 Terminal 27 Pulse Output Variable</i> .

5-63 Terminal 29 Pulse Output Variable		
Option:		Function:
		NOTICE! This parameter cannot be adjusted while the motor is running. Select the variable for viewing on terminal 29. Same options and functions as <i>parameter group 5-6* Pulse Output</i> .
[0] *	No operation	
[45]	Bus ctrl.	
[48]	Bus ctrl., timeout	
[51]	MCO controlled	
[100]	Output freq. 0-100	

5-63 Terminal 29 Pulse Output Variable		
Option:		Function:
[101]	Reference Min-Max	
[102]	Feedback +-200%	
[103]	Motor cur. 0-Imax	
[104]	Torque 0-Tlim	
[105]	Torque 0-Tnom	
[106]	Power 0-Pnom	
[107]	Speed 0-HighLim	
[108]	Torque +-160%	
[109]	Out frq 0-Fmax	
[113]	Ext. Closed Loop 1	
[114]	Ext. Closed Loop 2	
[115]	Ext. Closed Loop 3	
[116]	Cascade Reference	

5-65 Pulse Output Max Freq #29		
Range:		Function:
5000 Hz*	[0 - 32000 Hz]	Set the maximum frequency for terminal 29 corresponding to the output variable set in <i>parameter 5-63 Terminal 29 Pulse Output Variable</i> .

5-66 Terminal X30/6 Pulse Output Variable		
Select the variable for readout on terminal X30/6. This parameter is active when VLT® General Purpose I/O MCB 101 is installed in the frequency converter. Same options and functions as <i>parameter group 5-6* Pulse Outputs</i> .		
Option:		Function:
[0] *	No operation	
[45]	Bus ctrl.	
[48]	Bus ctrl., timeout	
[51]	MCO controlled	
[100]	Output frequency	
[101]	Reference	
[102]	Feedback	
[103]	Motor current	
[104]	Torque rel to limit	
[105]	Torq relate to rated	
[106]	Power	
[107]	Speed	
[108]	Torque	
[109]		
[119]		

5-68 Pulse Output Max Freq #X30/6		
Range:	Function:	
5000. Hz*	[0 - 32000 Hz]	<p>NOTICE!</p> <p>This parameter cannot be adjusted while the motor is running.</p> <p>Select the maximum frequency on terminal X30/6 referring to the output variable in parameter 5-66 Terminal X30/6 Pulse Output Variable.</p> <p>This parameter is active when VLT® General Purpose I/O MCB 101 is installed in the frequency converter.</p>

5-80 AHF Cap Reconnect Delay		
Range:	Function:	
25 s*	[1 - 120 s]	<p>Delay time between 2 consecutive AHF capacitor connections. The timer starts once the AHF capacitor disconnects, and connects back once delay expires and frequency converters power above 20% and below 30% of nominal power.</p>

AHF capacitor connect output function for digital and relay outputs

Functional description:

- Connect capacitors at 20% nominal power.
- Hysteresis ±50% of 20% nominal power (=minimum 10% and maximum 30% nominal power).
- Off delay timer=10 s. The nominal power must be below 10% for 10 s to disconnect the capacitors. If the nominal power exceeds 10% during the 10 s delay, the timer (10 s) restarts.
- The capacitor reconnect delay (default=25 s with a range 1–120 s, see parameter 5-80 AHF Cap Reconnect Delay) is used for the minimum off-time for the AHF capacitor output function.
- If there is a power loss, the frequency converter guarantees that the minimum off-time is respected when power is restored.

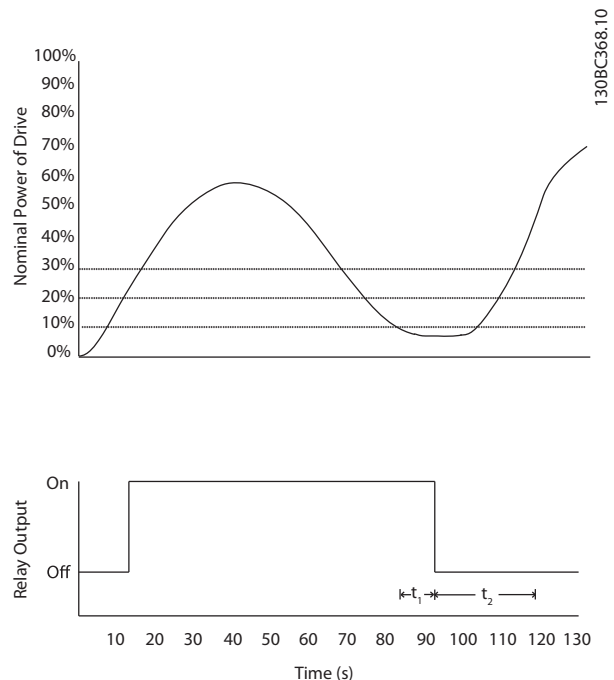

Figure 3.33 Example of the Output Function

t₁ shows the off delay timer (10 s).

t₂ shows the capacitor reconnect delay (parameter 5-80 AHF Cap Reconnect Delay).

When the nominal power of the frequency converter exceeds 20%, the output function turns on. When the power goes below 10%, an off delay timer has to expire before the output goes low. This is represented by t₁. After the output goes low, the capacitor reconnect delay timer has to expire before the output is allowed to be on again, shown by t₂. When t₂ expires, the nominal power is above 30% and the relay does not turn on.

3.7.7 5-9* Bus-controlled

This parameter group selects digital and relay outputs via a fieldbus setting.

5-90 Digital & Relay Bus Control																																							
Range:	Function:																																						
0* [0 - 2147483647]	<p>This parameter holds the state of the digital outputs and relays that are controlled by bus.</p> <p>A logical 1 indicates that the output is high or active.</p> <p>A logical 0 indicates that the output is low or inactive.</p> <table border="1" style="width: 100%; border-collapse: collapse;"> <tr><td>Bit 0</td><td>CC digital output, terminal 27</td></tr> <tr><td>Bit 1</td><td>CC digital output, terminal 29</td></tr> <tr><td>Bit 2</td><td>GPIO digital output, terminal X 30/6</td></tr> <tr><td>Bit 3</td><td>GPIO digital output, terminal X 30/7</td></tr> <tr><td>Bit 4</td><td>CC relay 1 output terminal</td></tr> <tr><td>Bit 5</td><td>CC relay 2 output terminal</td></tr> <tr><td>Bit 6</td><td>Option B relay 1 output terminal</td></tr> <tr><td>Bit 7</td><td>Option B relay 2 output terminal</td></tr> <tr><td>Bit 8</td><td>Option B relay 3 output terminal</td></tr> <tr><td>Bit 9–15</td><td>Reserved for future terminals</td></tr> <tr><td>Bit 16</td><td>Option C relay 1 output terminal</td></tr> <tr><td>Bit 17</td><td>Option C relay 2 output terminal</td></tr> <tr><td>Bit 18</td><td>Option C relay 3 output terminal</td></tr> <tr><td>Bit 19</td><td>Option C relay 4 output terminal</td></tr> <tr><td>Bit 20</td><td>Option C relay 5 output terminal</td></tr> <tr><td>Bit 21</td><td>Option C relay 6 output terminal</td></tr> <tr><td>Bit 22</td><td>Option C relay 7 output terminal</td></tr> <tr><td>Bit 23</td><td>Option C relay 8 output terminal</td></tr> <tr><td>Bit 24–31</td><td>Reserved for future terminals</td></tr> </table> <p style="text-align: center;">Table 3.16 Digital Output Bits</p>	Bit 0	CC digital output, terminal 27	Bit 1	CC digital output, terminal 29	Bit 2	GPIO digital output, terminal X 30/6	Bit 3	GPIO digital output, terminal X 30/7	Bit 4	CC relay 1 output terminal	Bit 5	CC relay 2 output terminal	Bit 6	Option B relay 1 output terminal	Bit 7	Option B relay 2 output terminal	Bit 8	Option B relay 3 output terminal	Bit 9–15	Reserved for future terminals	Bit 16	Option C relay 1 output terminal	Bit 17	Option C relay 2 output terminal	Bit 18	Option C relay 3 output terminal	Bit 19	Option C relay 4 output terminal	Bit 20	Option C relay 5 output terminal	Bit 21	Option C relay 6 output terminal	Bit 22	Option C relay 7 output terminal	Bit 23	Option C relay 8 output terminal	Bit 24–31	Reserved for future terminals
Bit 0	CC digital output, terminal 27																																						
Bit 1	CC digital output, terminal 29																																						
Bit 2	GPIO digital output, terminal X 30/6																																						
Bit 3	GPIO digital output, terminal X 30/7																																						
Bit 4	CC relay 1 output terminal																																						
Bit 5	CC relay 2 output terminal																																						
Bit 6	Option B relay 1 output terminal																																						
Bit 7	Option B relay 2 output terminal																																						
Bit 8	Option B relay 3 output terminal																																						
Bit 9–15	Reserved for future terminals																																						
Bit 16	Option C relay 1 output terminal																																						
Bit 17	Option C relay 2 output terminal																																						
Bit 18	Option C relay 3 output terminal																																						
Bit 19	Option C relay 4 output terminal																																						
Bit 20	Option C relay 5 output terminal																																						
Bit 21	Option C relay 6 output terminal																																						
Bit 22	Option C relay 7 output terminal																																						
Bit 23	Option C relay 8 output terminal																																						
Bit 24–31	Reserved for future terminals																																						

5-93 Pulse Out #27 Bus Control	
Range:	Function:
0 %* [0 - 100 %]	Contains the frequency to apply to the digital output terminal 27 when it is configured as bus-controlled.

5-94 Pulse Out #27 Timeout Preset	
Range:	Function:
0 %* [0 - 100 %]	Contains the frequency to apply to the digital output terminal 27 when it is configured as bus-controlled timeout, and timeout is detected.

5-95 Pulse Out #29 Bus Control	
Range:	Function:
0 %* [0 - 100 %]	Contains the frequency to apply to the digital output terminal 29 when it is configured as bus-controlled.

5-96 Pulse Out #29 Timeout Preset	
Range:	Function:
0 %* [0 - 100 %]	Contains the frequency to apply to the digital output terminal 29 when it is configured as bus-controlled timeout, and timeout is detected.

5-97 Pulse Out #X30/6 Bus Control	
Range:	Function:
0 %* [0 - 100 %]	Contains the frequency to apply to the digital output terminal 6 when it is configured as bus-controlled.

5-98 Pulse Out #X30/6 Timeout Preset	
Range:	Function:
0 %* [0 - 100 %]	Contains the frequency to apply to the digital output terminal 6 when it is configured as bus-controlled timeout, and timeout is detected.

3.8 Parameters 6-** Analog In/Out

3.8.1 6-0* Analog I/O Mode

Parameter group for setting up the analog I/O configuration.

The frequency converter is equipped with 2 analog inputs:

- Terminals 53.
- Terminals 54.

The analog inputs can be allocated freely to either voltage (0–10 V) or current input (0/4–20 mA).

NOTICE!

Thermistors may be connected to either an analog or a digital input.

6-00 Live Zero Timeout Time		
Range:	Function:	
10 s*	[1 - 99 s]	<p>Enter the live zero timeout in s. Live zero timeout time is active for analog inputs, that is terminal 53 or terminal 54, used as reference or feedback sources.</p> <p>If the reference signal value associated with the selected current input drops below 50% of the value set in:</p> <ul style="list-style-type: none"> • Parameter 6-10 Terminal 53 Low Voltage • Parameter 6-12 Terminal 53 Low Current • Parameter 6-20 Terminal 54 Low Voltage • Parameter 6-22 Terminal 54 Low Current <p>for a time period longer than the time set in parameter 6-00 Live Zero Timeout Time, the function selected in parameter 6-01 Live Zero Timeout Function is activated.</p>

6-01 Live Zero Timeout Function		
Option:	Function:	
		<p>Select the timeout function. The function set in parameter 6-01 Live Zero Timeout Function is activated if the input signal on terminal 53 or 54 is below 50% of the value in:</p> <ul style="list-style-type: none"> • Parameter 6-10 Terminal 53 Low Voltage. • Parameter 6-12 Terminal 53 Low Current. • Parameter 6-20 Terminal 54 Low Voltage. • Parameter 6-22 Terminal 54 Low Current. <p>The function can also be activated for a time period defined in parameter 6-00 Live Zero Timeout Time. If several timeouts occur simultaneously, the frequency converter prioritizes the timeout functions as follows:</p>

6-01 Live Zero Timeout Function		
Option:	Function:	
		<ol style="list-style-type: none"> 1. Parameter 6-01 Live Zero Timeout Function. 2. Parameter 8-04 Control Word Timeout Function.
[0]*	Off	
[1]	Freeze output	Frozen at the present value. Live zero timeout time does not apply to freeze output.
[2]	Stop	Overruled to stop.
[3]	Jogging	Overruled to jog speed.
[4]	Max. speed	Overruled to maximum speed.
[5]	Stop and trip	Overruled to stop with subsequent trip.

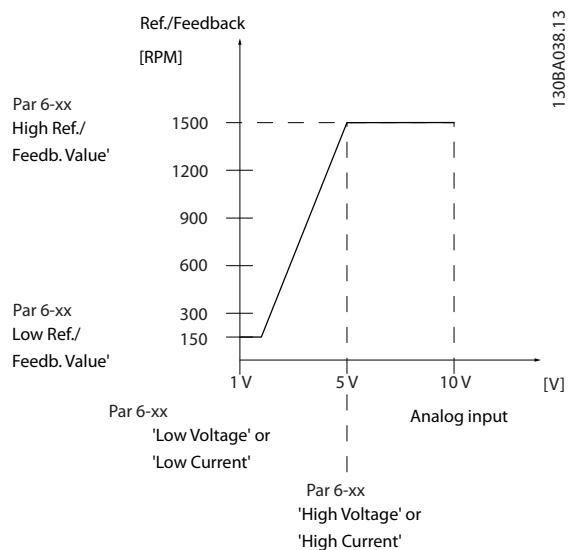

Figure 3.34 Live Zero Conditions

6-02 Emergency Mode Live Zero Timeout Function		
Option:	Function:	
[0] *	Off	Select the timeout function when the emergency mode is active. The function set in this parameter is activated if the input signal on analog inputs is lower than 50% of the low value for a time period defined in <i>parameter 6-00 Live Zero Timeout Time</i> .
[1]	Freeze output	Frozen at the present value.
[2]	Stop	Overruled to stop.
[3]	Jogging	Overruled to jog speed.
[4]	Max. speed	Overruled to maximum speed.

3.8.2 6-1* Analog Input 1

Parameters for configuring the scaling and limits for analog input 1 (terminal 53).

6-10 Terminal 53 Low Voltage		
Range:	Function:	
0.07 V* [0 - par. 6-11 V]	<p>NOTICE! For the live zero alarms to work, <i>parameter 6-10 Terminal 53 Low Voltage</i> must have a value of 1 V or greater.</p> <p>Enter the low voltage value. This analog input scaling value should correspond to the low reference feedback value set in <i>parameter 6-14 Terminal 53 Low Ref./Feedb. Value</i>.</p>	

6-11 Terminal 53 High Voltage		
Range:	Function:	
10 V* [par. 6-10 - 10 V]	Enter the high voltage value. This analog input scaling value should correspond to the high reference feedback value set in <i>parameter 6-15 Terminal 53 High Ref./Feedb. Value</i> .	

6-12 Terminal 53 Low Current		
Range:	Function:	
4 mA* [0 - par. 6-13 mA]	Enter the low current value. This reference signal should correspond to the low reference feedback value set in <i>parameter 6-14 Terminal 53 Low Ref./Feedb. Value</i> . Set the value at >2 mA to activate the live zero timeout function in <i>parameter 6-01 Live Zero Timeout Function</i> .	

6-13 Terminal 53 High Current		
Range:	Function:	
20 mA* [par. 6-12 - 20 mA]	Enter the high current value corresponding to the high reference/feedback set in <i>parameter 6-15 Terminal 53 High Ref./Feedb. Value</i> .	

6-14 Terminal 53 Low Ref./Feedb. Value		
Range:	Function:	
0 ReferenceFeed-backUnit* [-999999.999 - 999999.999 ReferenceFeed-backUnit]	Enter the analog input scaling value that corresponds to the low voltage/low current set in <i>parameter 6-10 Terminal 53 Low Voltage</i> and <i>parameter 6-12 Terminal 53 Low Current</i> .	

6-15 Terminal 53 High Ref./Feedb. Value		
Range:	Function:	
Size related* [-999999.999 - 999999.999 ReferenceFeed-backUnit]	Enter the analog input scaling value that corresponds to the high voltage/high current value set in <i>parameter 6-11 Terminal 53 High Voltage</i> and <i>parameter 6-13 Terminal 53 High Current</i> .	

6-16 Terminal 53 Filter Time Constant		
Range:	Function:	
0.005 s* [0.005 - 10 s]	<p>NOTICE! This parameter cannot be adjusted while the motor is running.</p> <p>Enter the filter time constant. This constant is a first-order digital low-pass filter time for suppressing electrical noise in terminal 53. A high value improves dampening but also increases the delay through the filter.</p>	

6-17 Terminal 53 Live Zero		
Option:	Function:	
[0]	Disabled	This parameter makes it possible to disable the live zero monitoring. For example, this is used if the analog outputs are used as part of a decentral I/O system (for example when not part of any control functions related to the frequency converter, but feeding an external control system with data).
[1] *	Enabled	

3.8.3 6-2* Analog Input 2

Parameters for configuring the scaling and limits for analog input 2 (terminal 54).

6-20 Terminal 54 Low Voltage		
Range:		Function:
0.07 V*	[0 - par. 6-21 V]	Enter the low voltage value. This analog input scaling value should correspond to the low reference feedback value set in <i>parameter 6-24 Terminal 54 Low Ref./Feedb. Value</i> .

6-21 Terminal 54 High Voltage		
Range:		Function:
10 V*	[par. 6-20 - 10 V]	Enter the high voltage value. This analog input scaling value should correspond to the high reference feedback value set in <i>parameter 6-25 Terminal 54 High Ref./Feedb. Value</i> .

6-22 Terminal 54 Low Current		
Range:		Function:
4 mA*	[0 - par. 6-23 mA]	Enter the low current value. This reference signal should correspond to the low reference feedback value set in <i>parameter 6-24 Terminal 54 Low Ref./Feedb. Value</i> . Set the value at >2 mA to activate the live zero timeout function in <i>parameter 6-01 Live Zero Timeout Function</i> .

6-23 Terminal 54 High Current		
Range:		Function:
20 mA*	[par. 6-22 - 20 mA]	Enter the high current value corresponding to the high reference feedback value set in <i>parameter 6-25 Terminal 54 High Ref./Feedb. Value</i> .

6-24 Terminal 54 Low Ref./Feedb. Value		
Range:		Function:
0 ReferenceFeed-backUnit*	[-999999.999 - 999999.999 ReferenceFeed-backUnit]	Enter the analog input scaling value that corresponds to the low voltage/low current value set in <i>parameter 6-20 Terminal 54 Low Voltage</i> and <i>parameter 6-22 Terminal 54 Low Current</i> .

6-25 Terminal 54 High Ref./Feedb. Value		
Range:		Function:
100 Reference-FeedbackUnit*	[-999999.999 - 999999.999 ReferenceFeed-backUnit]	Enter the analog input scaling value that corresponds to the high voltage/high current value set in <i>parameter 6-21 Terminal 54 High Voltage</i> and <i>parameter 6-23 Terminal 54 High Current</i> .

6-26 Terminal 54 Filter Time Constant		
Range:		Function:
0.005 s*	[0.005 - 10 s]	<p>NOTICE!</p> <p>This parameter cannot be adjusted while the motor is running.</p> <p>Enter the filter time constant. This is a first-order digital low-pass filter time constant for suppressing electrical noise in terminal 54. Increasing the value improves dampening but also increases the time delay through the filter.</p>

6-27 Terminal 54 Live Zero		
Option:		Function:
[0]	Disabled	
[1] *	Enabled	This parameter makes it possible to disable the live zero monitoring. For example, this is used if the analog outputs are used as part of a decentral I/O system (for example when not part of any control functions related to the frequency converter, but feeding an external control system with data).

3.8.4 6-3* Analog Input X30/11

Parameter group for configuring the scale and limits for analog input 3 (X30/11) placed on VLT® General Purpose I/O MCB 101.

6-30 Terminal X30/11 Low Voltage		
Range:		Function:
0.07 V*	[0 - par. 6-31 V]	Sets the analog input scaling value to correspond to the low reference feedback value (set in <i>parameter 6-34 Term. X30/11 Low Ref./Feedb. Value</i>).

6-31 Terminal X30/11 High Voltage		
Range:		Function:
10 V*	[par. 6-30 - 10 V]	Sets the analog input scaling value to correspond to the high reference feedback value (set in <i>parameter 6-35 Term. X30/11 High Ref./Feedb. Value</i>).

6-34 Term. X30/11 Low Ref./Feedb. Value		
Range:		Function:
0 ReferenceFeed-backUnit*	[-999999.999 - 999999.999 ReferenceFeed-backUnit]	Sets the analog input scaling value to correspond to the low voltage value (set in <i>parameter 6-30 Terminal X30/11 Low Voltage</i>).

6-35 Term. X30/11 High Ref./Feedb. Value		
Range:		Function:
100 Reference-FeedbackUnit*	[-999999.999 - 999999.999 ReferenceFeed-backUnit]	Sets the analog input scaling value to correspond to the high-voltage value (set in <i>parameter 6-31 Terminal X30/11 High Voltage</i>).

6-36 Term. X30/11 Filter Time Constant		
Range:		Function:
0.005 s*	[0.005 - 10 s]	<p>NOTICE!</p> <p>This parameter cannot be adjusted while the motor is running.</p> <p>Enter the filter time constant. This constant is a first-order digital low-pass filter time for suppressing electrical noise in terminal X30/11. A high value improves dampening but also increases the delay through the filter.</p>

6-37 Term. X30/11 Live Zero		
Option:		Function:
[0]	Disabled	This parameter makes it possible to disable the live zero monitoring. For example, this is used if the analog outputs are used as part of a decentral I/O system (for example when not part of any control functions related to the frequency converter, but feeding an external control system with data).
[1] *	Enabled	

3.8.5 6-4* Analog Input X30/12

Parameter group for configuring the scale and limits for analog input 4 (X30/12) placed on VLT® General Purpose I/O MCB 101.

6-40 Terminal X30/12 Low Voltage		
Range:		Function:
0.07 V*	[0 - par. 6-41 V]	Sets the analog input scaling value to correspond to the low reference feedback value set in <i>parameter 6-44 Term. X30/12 Low Ref./Feedb. Value</i> .

6-41 Terminal X30/12 High Voltage		
Range:		Function:
10 V*	[par. 6-40 - 10 V]	Sets the analog input scaling value to correspond to the high reference feedback value set in <i>parameter 6-45 Term. X30/12 High Ref./Feedb. Value</i> .

6-44 Term. X30/12 Low Ref./Feedb. Value		
Range:		Function:
0 ReferenceFeed-backUnit*	[-999999.999 - 999999.999 ReferenceFeed-backUnit]	Sets the analog output scaling value to correspond to the low voltage value set in <i>parameter 6-40 Terminal X30/12 Low Voltage</i> .

6-45 Term. X30/12 High Ref./Feedb. Value		
Range:		Function:
100 Reference-FeedbackUnit*	[-999999.999 - 999999.999 ReferenceFeed-backUnit]	Sets the analog input scaling value to correspond to the high voltage value set in <i>parameter 6-41 Terminal X30/12 High Voltage</i> .

6-46 Term. X30/12 Filter Time Constant		
Range:		Function:
0.005 s*	[0.005 - 10 s]	<p>NOTICE!</p> <p>This parameter cannot be adjusted while the motor is running.</p> <p>Enter the filter time constant. This constant is a first-order digital low-pass filter time for suppressing electrical noise in terminal X30/12. A high value improves dampening but also increases the delay through the filter.</p>

6-47 Term. X30/12 Live Zero		
Option:		Function:
		This parameter makes it possible to disable the live zero monitoring. For example, this is used if the analog outputs are used as part of a decentral I/O system (for example when not part of any control functions related to the frequency converter, but feeding an external control system with data).
[0]	Disabled	
[1] *	Enabled	

3.8.6 6-5* Analog Output 1

Parameters for configuring the scaling and limits for analog output 1, that is terminal 42. Analog outputs are current outputs: 0/4–20 mA. Common terminal (terminal 39) is the same terminal and has the same electrical potential for analog common and digital common connection. Resolution on analog output is 12 bit.

6-50 Terminal 42 Output		
Option:		Function:
		<p>NOTICE!</p> <p>Values for setting the minimum reference are found in <i>parameter 3-02 Minimum Reference</i> and values for maximum reference in <i>parameter 3-03 Maximum Reference</i>.</p> <p>Select the function of terminal 42 as an analog current output. A motor current of 20 mA corresponds to I_{max}.</p>
[0]	No operation	
[52]	MCO 0-20mA/ 0-10V	

6-50 Terminal 42 Output		
Option:		Function:
[53]	MCO 4-20mA	
[100] *	Output freq. 0-100	0–100 Hz (0–20 mA).
[101]	Reference Min-Max	Minimum reference - maximum reference (0–20 mA).
[102]	Feedback +-200%	-200% to +200% of <i>parameter 3-03 Maximum Reference</i> (0–20 mA).
[103]	Motor cur. 0-I _{max}	0–Inverter maximum current (<i>parameter 16-37 Inv. Max. Current</i>), (0–20 mA)
[104]	Torque 0-Tlim	0–Torque limit (<i>parameter 4-16 Torque Limit Motor Mode</i>), (0–20 mA).
[105]	Torque 0-Tnom	0–Motor rated torque (0–20 mA).
[106]	Power 0-Pnom	0–Motor rated power (0–20 mA).
[107]	Speed 0-HighLim	0–Speed high limit (<i>parameter 4-13 Motor Speed High Limit [RPM]</i> and <i>parameter 4-14 Motor Speed High Limit [Hz]</i>), (0–20 mA)
[108]	Torque +-160%	(0–20 mA).
[109]	Out freq 0-Fmax	
[113]	Ext. Closed Loop 1	0–100% (0–20 mA).
[114]	Ext. Closed Loop 2	0–100% (0–20 mA).
[115]	Ext. Closed Loop 3	0–100% (0–20 mA).
[116]	Cascade Reference	
[117]	Shaft Power	
[118]	Shaft Power 4-20mA	
[130]	Out freq 0-100 4-20mA	0–100 Hz.
[131]	Reference 4-20mA	Minimum reference–maximum reference.
[132]	Feedback 4-20mA	-200% to +200% of <i>parameter 3-03 Maximum Reference</i> .
[133]	Motor cur. 4-20mA	0–Inverter maximum current (<i>parameter 16-37 Inv. Max. Current</i>).
[134]	Torq.0-lim 4-20 mA	0–Torque limit (<i>parameter 4-16 Torque Limit Motor Mode</i>).

6-50 Terminal 42 Output										
Option:	Function:									
[135]	Torq.0-nom 4-20mA	0–Motor rated torque.								
[136]	Power 4-20mA	0–Motor rated power.								
[137]	Speed 4-20mA	0–Speed high limit (<i>parameter 4-13 Motor Speed High Limit [RPM] and parameter 4-14 Motor Speed High Limit [Hz]</i>).								
[138]	Torque 4-20mA									
[139]	Bus ctrl. 4-20 mA	0–100% (0–20 mA)								
[140]	Bus ctrl. 4-20 mA	0–100%.								
[141]	Bus ctrl t.o. 4-20 mA	0–100% (0–20 mA).								
[142]	Bus ctrl t.o. 4-20mA	0–100%.								
[143]	Ext. CL 1 4-20mA	0–100%.								
[144]	Ext. CL 2 4-20mA	0–100%.								
[145]	Ext. CL 3 4-20mA	0–100%.								
[146]	Cascade Ref. 4-20mA									
[147]	Main act val 0-20mA									
[148]	Main act val 4-20mA									
[150]	Out frq 0-Fmax 4-20mA									
[156]	Flow Rate									
[157]	Flow Rate 4-20mA									
[254]	DC Link 0-20mA	<p>With this parameter selected, the terminal output shows the scaled DC-link voltage. <i>Table 3.17</i> shows the relationship between the DC-link voltage and the terminal output.</p> <table border="1"> <thead> <tr> <th>DC-link voltage (V)</th> <th>Terminal output</th> </tr> </thead> <tbody> <tr> <td>$V \leq \text{undervoltage limit}$</td> <td>0%</td> </tr> <tr> <td>$V \geq \text{overvoltage limit}$</td> <td>100%</td> </tr> <tr> <td>Voltage within range: Undervoltage <V <overvoltage</td> <td>Linearly interpolated</td> </tr> </tbody> </table> <p>Table 3.17 Relationship between the DC-link Voltage and the Terminal Output</p>	DC-link voltage (V)	Terminal output	$V \leq \text{undervoltage limit}$	0%	$V \geq \text{overvoltage limit}$	100%	Voltage within range: Undervoltage <V <overvoltage	Linearly interpolated
DC-link voltage (V)	Terminal output									
$V \leq \text{undervoltage limit}$	0%									
$V \geq \text{overvoltage limit}$	100%									
Voltage within range: Undervoltage <V <overvoltage	Linearly interpolated									

6-50 Terminal 42 Output																				
Option:	Function:																			
		<p><i>Table 3.18</i> shows the undervoltage and overvoltage limits for different frequency converter sizes.</p> <table border="1"> <thead> <tr> <th>Frequency converter size</th> <th>Undervoltage limit [V]</th> <th>Overvoltage limit [V]</th> </tr> </thead> <tbody> <tr> <td>T2/S2</td> <td>185</td> <td>410</td> </tr> <tr> <td>T4/S4</td> <td>373</td> <td>855</td> </tr> <tr> <td>T6/T7</td> <td>553</td> <td>1130</td> </tr> </tbody> </table> <p>Table 3.18 Undervoltage and Overvoltage Limits for Different Frequency Converter Sizes</p> <table border="1"> <tbody> <tr> <td>1</td> <td>Analog output</td> </tr> <tr> <td>2</td> <td>Undervoltage limit</td> </tr> <tr> <td>3</td> <td>Overvoltage limit</td> </tr> </tbody> </table> <p>Figure 3.35 Example: The Analog Output of Terminal 42 on the T4 Frequency Converter with Option [254] DC Link 0–20 mA Selected</p>	Frequency converter size	Undervoltage limit [V]	Overvoltage limit [V]	T2/S2	185	410	T4/S4	373	855	T6/T7	553	1130	1	Analog output	2	Undervoltage limit	3	Overvoltage limit
Frequency converter size	Undervoltage limit [V]	Overvoltage limit [V]																		
T2/S2	185	410																		
T4/S4	373	855																		
T6/T7	553	1130																		
1	Analog output																			
2	Undervoltage limit																			
3	Overvoltage limit																			
[255]	DC Link 4-20mA	The function is the same as [254] DC Link 0–20 mA.																		

3

6-51 Terminal 42 Output Min Scale		
Range:	Function:	
0 %* [0 - 200 %]	Scale for the minimum output (0 mA or 4 mA) of the analog signal at terminal 42. Set the value to be the percentage of the full range of the variable selected in <i>parameter 6-50 Terminal 42 Output</i> .	

6-52 Terminal 42 Output Max Scale		
Range:	Function:	
100 %* [0 - 200 %]	Scale for the maximum output (20 mA) of the analog signal at terminal 42. Set the value to be the percentage of the full range of the variable selected in <i>parameter 6-50 Terminal 42 Output</i> .	
	<p>Figure 3.36 Output Current vs Reference Variable</p> <p>It is possible to obtain a value lower than 20 mA at full scale by programming values >100% by using a formula as follows:</p> $20 \text{ mA} / \text{desired maximum current} \times 100 \%$ <p>i. e. $10 \text{ mA} : \frac{20 \text{ mA}}{10 \text{ mA}} \times 100 \% = 200 \%$</p>	

Example 1:

Variable value = output frequency, range = 0–100 Hz.
 Range needed for output = 0–50 Hz.
 Output signal 0 mA or 4 mA is needed at 0 Hz (0% of range). Set *parameter 6-51 Terminal 42 Output Min Scale* to 0%.
 Output signal 20 mA is needed at 50 Hz (50% of range). Set *parameter 6-52 Terminal 42 Output Max Scale* to 50%.

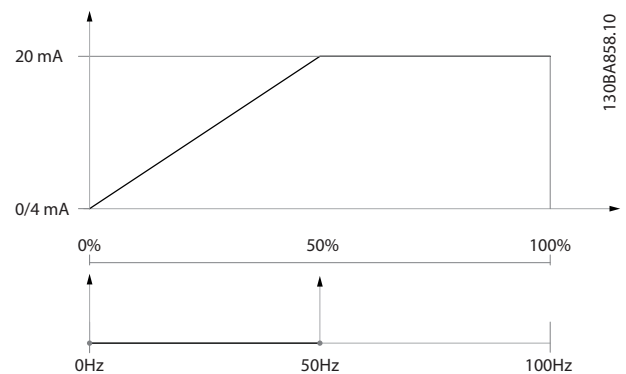

Figure 3.37 Example 1

Example 2:

Variable = feedback, range = -200% to +200%.
 Range needed for output = 0–100%.
 Output signal 0 mA or 4 mA is needed at 0% (50% of range). Set *parameter 6-51 Terminal 42 Output Min Scale* to 50%.
 Output signal 20 mA is needed at 100% (75% of range). Set *parameter 6-52 Terminal 42 Output Max Scale* to 75%.

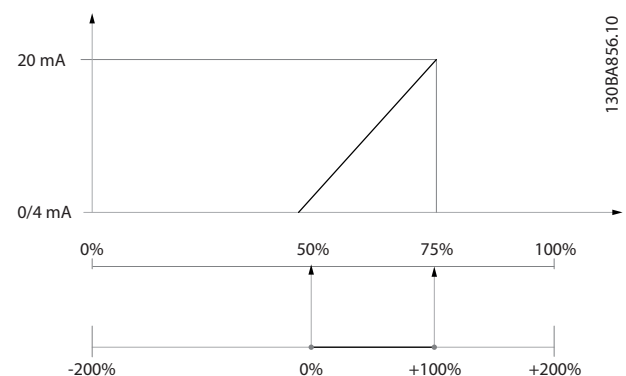

Figure 3.38 Example 2

Example 3:

Variable value = reference, range = minimum reference–maximum reference
 Range needed for output = minimum reference (0%)–maximum reference (100%), 0–10 mA.
 Output signal 0 mA or 4 mA is needed at minimum reference. Set *parameter 6-51 Terminal 42 Output Min Scale* to 0%.
 Output signal 10 mA is needed at maximum reference (100% of range). Set *parameter 6-52 Terminal 42 Output Max Scale* to 200%.
 (20 mA/10 mA x 100%=200%).

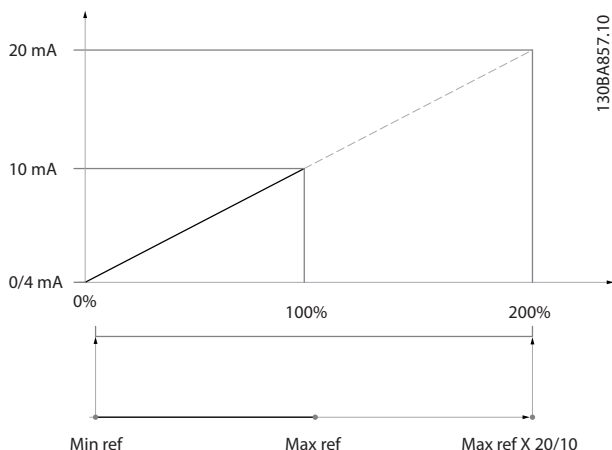

Figure 3.39 Example 3

6-53 Terminal 42 Output Bus Control

Range:	Function:
0 %* [0 - 100 %]	Holds the level of output 42 if controlled by bus.

6-54 Terminal 42 Output Timeout Preset

Range:	Function:
0 %* [0 - 100 %]	Holds the preset level of output 42. If a timeout function is selected in <i>parameter 6-50 Terminal 42 Output</i> , the output is preset to this level if a fieldbus timeout occurs.

6-55 Terminal 42 Output Filter

Option:	Function:																		
	The following readout parameters from selection in <i>parameter 6-50 Terminal 42 Output</i> have a filter selected when <i>parameter 6-55 Terminal 42 Output Filter</i> is on:																		
	<table border="1"> <thead> <tr> <th>Selection</th> <th>0–20 mA</th> <th>4–20 mA</th> </tr> </thead> <tbody> <tr> <td>Motor current (0–I_{max})</td> <td>[103]</td> <td>[133]</td> </tr> <tr> <td>Torque limit (0–T_{lim})</td> <td>[104]</td> <td>[134]</td> </tr> <tr> <td>Rated torque (0–T_{nom})</td> <td>[105]</td> <td>[135]</td> </tr> <tr> <td>Power (0–P_{nom})</td> <td>[106]</td> <td>[136]</td> </tr> <tr> <td>Speed (0–Speed_{max})</td> <td>[107]</td> <td>[137]</td> </tr> </tbody> </table>	Selection	0–20 mA	4–20 mA	Motor current (0–I _{max})	[103]	[133]	Torque limit (0–T _{lim})	[104]	[134]	Rated torque (0–T _{nom})	[105]	[135]	Power (0–P _{nom})	[106]	[136]	Speed (0–Speed _{max})	[107]	[137]
Selection	0–20 mA	4–20 mA																	
Motor current (0–I _{max})	[103]	[133]																	
Torque limit (0–T _{lim})	[104]	[134]																	
Rated torque (0–T _{nom})	[105]	[135]																	
Power (0–P _{nom})	[106]	[136]																	
Speed (0–Speed _{max})	[107]	[137]																	
	Table 3.19 Readout Parameters																		
[0] *	Off Filter off.																		
[1]	On Filter on.																		

3.8.7 6-6* Analog Output X30/8

Analog outputs are current outputs: 0/4–20 mA. Common terminal (terminal X30/8) is the same terminal and electrical potential for analog common connection. Resolution on analog output is 12 bit.

6-60 Terminal X30/8 Output

Same options and functions as *parameter 6-50 Terminal 42 Output*.

6-61 Terminal X30/8 Min. Scale

Range:	Function:
0 %* [0 - 200 %]	Scales the minimum output of the selected analog signal on terminal X30/8. Scale the minimum value as a percentage of the maximum signal value. For example, enter the value 25% if the output should be 0 mA at 25% of the maximum output value. The value can never exceed the corresponding setting in <i>parameter 6-62 Terminal X30/8 Max. Scale</i> if the value is below 100%. This parameter is active when VLT® General Purpose I/O MCB 101 is mounted in the frequency converter.

6-62 Terminal X30/8 Max. Scale

Range:	Function:
100 %* [0 - 200 %]	Scales the maximum output of the selected analog signal on terminal X30/8. Scale the value to the required maximum value of the current signal output. Scale the output to give a lower current than 20 mA at full scale, or 20 mA at an output below 100% of the maximum signal value. If 20 mA is the required output current at a value between 0–100% of the full-scale output, program the percentage value in the parameter, that is 50%=20 mA. If a current 4–20 mA is required at maximum output (100%), calculate the percentage value as follows: $20 \text{ mA} / \text{desired maximum current} \times 100 \%$ <i>i.e.</i> $10 \text{ mA} : \frac{20 \text{ mA}}{10 \text{ mA}} \times 100 \% = 200 \%$

6-63 Terminal X30/8 Output Bus Control

Range:	Function:
0 %* [0 - 100 %]	Contains the value to apply to the output terminal when it is configured as bus-controlled.

6-64 Terminal X30/8 Output Timeout Preset

Range:	Function:
0 %* [0 - 100 %]	Contains the value to apply to the output terminal when it is configured as bus-controlled timeout and timeout is detected.

6-70 Terminal X45/1 Output		
Select the output of terminal X45/1 of VLT® Extended Relay Card MCB 113.		
Option:	Function:	
[0] *	No operation	
[52]	MCO 0-20mA/0-10V	
[53]	MCO 4-20mA	
[100]	Output freq. 0-100	
[101]	Reference Min-Max	
[102]	Feedback +-200%	
[103]	Motor cur. 0-I _{max}	
[104]	Torque 0-T _{lim}	
[105]	Torque 0-T _{nom}	
[106]	Power 0-P _{nom}	
[107]	Speed 0-HighLim	
[108]	Torque +-160%	
[109]	Out frq 0-F _{max}	
[113]	Ext. Closed Loop 1	
[114]	Ext. Closed Loop 2	
[115]	Ext. Closed Loop 3	
[116]	Cascade Reference	
[117]	Shaft Power	
[118]	Shaft Power 4-20mA	
[130]	Out frq 0-100 4-20mA	
[131]	Reference 4-20mA	
[132]	Feedback 4-20mA	
[133]	Motor cur. 4-20mA	
[134]	Torq.0-lim 4-20 mA	
[135]	Torq.0-nom 4-20mA	
[136]	Power 4-20mA	
[137]	Speed 4-20mA	
[138]	Torque 4-20mA	
[139]	Bus ctrl.	
[140]	Bus ctrl. 4-20 mA	
[141]	Bus ctrl t.o.	
[142]	Bus ctrl t.o. 4-20mA	
[143]	Ext. CL 1 4-20mA	
[144]	Ext. CL 2 4-20mA	
[145]	Ext. CL 3 4-20mA	
[146]	Cascade Ref. 4-20mA	
[147]	Main act val 0-20mA	
[148]	Main act val 4-20mA	
[150]	Out frq 0-F _{max} 4-20mA	
[156]	Flow Rate	
[157]	Flow Rate 4-20mA	
[254]	DC Link 0-20mA	
[255]	DC Link 4-20mA	

6-71 Terminal X45/1 Min. Scale		
Enter the minimum scaling value of output of the analog signal on terminal X45/1.		
Range:	Function:	
0 %*	[0 - 200 %]	

6-72 Terminal X45/1 Max. Scale		
Enter the maximum scaling value of output of the analog signal on terminal X45/1.		
Range:	Function:	
100 %*	[0 - 200 %]	

6-73 Terminal X45/1 Bus Control		
Enter the output value for terminal X45/1 when the fieldbus controls the terminal.		
Range:	Function:	
0 %*	[0 - 100 %]	

6-74 Terminal X45/1 Output Timeout Preset		
Enter the output value for terminal X45/1 when the bus control timeout for the terminal is detected.		
Range:	Function:	
0 %*	[0 - 100 %]	

6-80 Terminal X45/3 Output		
Select the output of terminal X45/3 of VLT® Extended Relay Card MCB 113.		
Option:	Function:	
[0] *	No operation	
[52]	MCO 0-20mA/0-10V	
[53]	MCO 4-20mA	
[100]	Output freq. 0-100	
[101]	Reference Min-Max	
[102]	Feedback +-200%	
[103]	Motor cur. 0-I _{max}	
[104]	Torque 0-T _{lim}	
[105]	Torque 0-T _{nom}	
[106]	Power 0-P _{nom}	
[107]	Speed 0-HighLim	
[108]	Torque +-160%	
[109]	Out frq 0-F _{max}	
[113]	Ext. Closed Loop 1	
[114]	Ext. Closed Loop 2	
[115]	Ext. Closed Loop 3	
[116]	Cascade Reference	
[117]	Shaft Power	
[118]	Shaft Power 4-20mA	
[130]	Out frq 0-100 4-20mA	
[131]	Reference 4-20mA	
[132]	Feedback 4-20mA	
[133]	Motor cur. 4-20mA	

6-80 Terminal X45/3 Output		
Select the output of terminal X45/3 of VLT® Extended Relay Card MCB 113.		
Option:	Function:	
[134]	Torq.0-lim 4-20 mA	
[135]	Torq.0-nom 4-20mA	
[136]	Power 4-20mA	
[137]	Speed 4-20mA	
[138]	Torque 4-20mA	
[139]	Bus ctrl.	
[140]	Bus ctrl. 4-20 mA	
[141]	Bus ctrl t.o.	
[142]	Bus ctrl t.o. 4-20mA	
[143]	Ext. CL 1 4-20mA	
[144]	Ext. CL 2 4-20mA	
[145]	Ext. CL 3 4-20mA	
[146]	Cascade Ref. 4-20mA	
[147]	Main act val 0-20mA	
[148]	Main act val 4-20mA	
[150]	Out frq 0-Fmax 4-20mA	
[156]	Flow Rate	
[157]	Flow Rate 4-20mA	
[254]	DC Link 0-20mA	
[255]	DC Link 4-20mA	

6-81 Terminal X45/3 Min. Scale		
Enter the minimum scaling value of output of the analog signal on terminal X45/3.		
Range:	Function:	
0 %*	[0 - 200 %]	

6-82 Terminal X45/3 Max. Scale		
Enter the maximum scaling value of output of the analog signal on terminal X45/3.		
Range:	Function:	
100 %*	[0 - 200 %]	

6-83 Terminal X45/3 Bus Control		
Enter the output value for terminal X45/3 when the fieldbus controls the terminal.		
Range:	Function:	
0 %*	[0 - 100 %]	

6-84 Terminal X45/3 Output Timeout Preset		
Enter the output value for terminal X45/3 when the bus control timeout for the terminal is detected.		
Range:	Function:	
0 %*	[0 - 100 %]	

3.9 Parameters 8-** Communications and Options

3.9.1 8-0* General Settings

8-01 Control Site		
The setting in this parameter overrides the settings in <i>parameter 8-50 Coasting Select</i> to <i>parameter 8-56 Preset Reference Select</i> .		
Option:		Function:
[0] *	Digital and ctrl.word	Use both digital input and control word.
[1]	Digital only	Use digital inputs only.
[2]	Controlword only	Use control word only.

8-02 Control Word Source		
Option:		Function:
<p>NOTICE! This parameter cannot be adjusted while the motor is running.</p> <p>Select the source of the control word: 1 of 2 serial interfaces or 4 installed options. During initial power-up, the frequency converter automatically sets this parameter to [3] <i>Option A</i> if it detects a valid fieldbus option installed in slot A. If the option is removed, the frequency converter detects a change in the configuration, sets <i>parameter 8-02 Control Source</i> to default setting [1] <i>FC Port</i>, and the frequency converter then trips. If an option is installed after initial power-up, the setting of <i>parameter 8-02 Control Source</i> does not change, but the frequency converter trips and shows <i>alarm 67, Option Changed</i>.</p>		
[0]	None	
[1]	FC RS-485	
[2]	FC USB	
[3] *	Option A	
[4]	Option B	
[5]	Option C0	
[6]	Option C1	
[30]	External Can	

8-03 Control Timeout Time		
Range:		Function:
Size related*	[1 - 18000 s]	Enter the maximum time expected to pass between the reception of 2 consecutive telegrams. If this time is exceeded, it indicates that the serial communication has stopped. The function selected in

8-03 Control Timeout Time		
Range:		Function:
		<p><i>parameter 8-04 Control Timeout Function</i> is then carried out. A valid control word triggers the timeout counter. The minimum value that can be set depends on the actual frequency converter used.</p> <p>The object list holds information on the objects that triggers the control timeout:</p> <ul style="list-style-type: none"> • Analog outputs • Binary outputs • AV0 • AV1 • AV2 • AV4 • BV1 • BV2 • BV3 • BV4 • BV5 • Multistate outputs

8-04 Control Timeout Function		
<p>Select the timeout function. The timeout function is activated when the control word fails to be updated within the time period specified in <i>parameter 8-03 Control Timeout Time</i>. [20] <i>N2 Override Release</i> only appears after setting the Metasys N2 protocol.</p> <p>To change the set-up after a timeout, configure as follows:</p> <ol style="list-style-type: none"> 1. Set <i>parameter 0-10 Active Set-up</i> to [9] <i>Multi set-up</i>. 2. Select the relevant link in <i>parameter 0-12 This Set-up Linked to</i>. 		
Option:		Function:
[0] *	Off	Resumes control via fieldbus (fieldbus or standard), using the most recent control word.
[1]	Freeze output	Freezes output frequency until communication resumes.
[2]	Stop	Stops with auto restart when communication resumes.
[3]	Jogging	Runs the motor at jog frequency until communication resumes.
[4]	Max. speed	Runs the motor at maximum frequency until communication resumes.

8-04 Control Timeout Function		
<p>Select the timeout function. The timeout function is activated when the control word fails to be updated within the time period specified in <i>parameter 8-03 Control Timeout Time</i>. [20] N2 <i>Override Release</i> only appears after setting the Metasys N2 protocol.</p> <p>To change the set-up after a timeout, configure as follows:</p> <ol style="list-style-type: none"> Set <i>parameter 0-10 Active Set-up</i> to [9] <i>Multi set-up</i>. Select the relevant link in <i>parameter 0-12 This Set-up Linked to</i>. 		
Option:		Function:
[5]	Stop and trip	Stops the motor, then resets the frequency converter to restart via: <ul style="list-style-type: none"> Fieldbus. [Reset]. Digital input.
[7]	Select setup 1	Changes the set-up after a control word timeout. If communication resumes after a timeout, <i>parameter 8-05 End-of-Timeout Function</i> either resumes the set-up used before the timeout, or retains the set-up endorsed by the timeout function.
[8]	Select setup 2	See [7] <i>Select set-up 1</i> .
[9]	Select setup 3	See [7] <i>Select set-up 1</i> .
[10]	Select setup 4	See [7] <i>Select set-up 1</i> .
[20]	N2 Override Release	
[27]	Forced stop and trip	

8-05 End-of-Timeout Function		
<p>Select the action after receiving a valid control word following a timeout.</p> <p>This parameter is active only when <i>parameter 8-04 Control Timeout Function</i> is set to:</p> <ul style="list-style-type: none"> [7] <i>Set-up 1</i>. [8] <i>Set-up 2</i>. [9] <i>Set-up 3</i>. [10] <i>Set-up 4</i>. 		
Option:		Function:
[0]	Hold set-up	Retains the set-up selected in <i>parameter 8-04 Control Timeout Function</i> and shows a warning until <i>parameter 8-06 Reset Control Timeout</i> toggles. Then the frequency

8-05 End-of-Timeout Function		
<p>Select the action after receiving a valid control word following a timeout.</p> <p>This parameter is active only when <i>parameter 8-04 Control Timeout Function</i> is set to:</p> <ul style="list-style-type: none"> [7] <i>Set-up 1</i>. [8] <i>Set-up 2</i>. [9] <i>Set-up 3</i>. [10] <i>Set-up 4</i>. 		
Option:		Function:
		converter resumes its original set-up.
[1] *	Resume set-up	Resumes the set-up that was active before the timeout.

8-06 Reset Control Timeout		
<p>This parameter is active only when option [0] <i>Hold set-up</i> has been selected in <i>parameter 8-05 End-of-Timeout Function</i>.</p>		
Option:		Function:
[0] *	Do not reset	Retains the set-up specified in <i>parameter 8-04 Control Timeout Function</i> : <ul style="list-style-type: none"> [7] <i>Set-up 1</i>. [8] <i>Set-up 2</i>. [9] <i>Set-up 3</i>. [10] <i>Set-up 4</i>.
[1]	Do reset	Restores the frequency converter to the original set-up following a control word timeout. The frequency converter performs the reset and immediately reverts to the [0] <i>Do not reset</i> setting.

8-07 Diagnosis Trigger		
<p>Not all fieldbuses support the diagnosis functions.</p>		
Option:		Function:
[0] *	Disable	Send no extended diagnosis data (EDD).
[1]	Trigger on alarms	Send EDD after alarms.
[2]	Trigger alarm/warn.	Send EDD after alarms or warnings.

8-08 Readout Filtering		
<p>If the speed feedback value readouts on fieldbus are fluctuating, this function is used. Select filtered, if the function is required. A power cycle is required for changes to take effect.</p>		
Option:		Function:
[0]	Motor Data Std-Filt.	Normal fieldbus readouts.
[1]	Motor Data LP-Filter	Filtered fieldbus readouts of the following parameters:

8-08 Readout Filtering		
If the speed feedback value readouts on fieldbus are fluctuating, this function is used. Select filtered, if the function is required. A power cycle is required for changes to take effect.		
Option:	Function:	
	<ul style="list-style-type: none"> Parameter 16-10 Power [kW]. Parameter 16-11 Power [hp]. Parameter 16-12 Motor voltage. Parameter 16-14 Motor Current. Parameter 16-16 Torque [Nm]. Parameter 16-17 Speed [RPM]. Parameter 16-22 Torque [%]. 	

3.9.2 8-1* Ctrl. Word Settings

8-10 Control Profile		
Select the interpretation of the control and status words corresponding to the installed fieldbus. Only the selections valid for the fieldbus installed in slot A are visible in the LPC display. For guidelines in selection of [0] Frequency converter profile and [1] PROFdrive profile, refer to the design guide of the related product. For more guidelines in the selection of [1] PROFdrive profile, [5] ODVA, and [7] CANopen DSP 402, see the installation guide for the installed fieldbus.		
Option:	Function:	
[0] *	FC profile	
[1]	PROFdrive profile	
[5]	ODVA	Available only with VLT® DeviceNet MCA 104 and VLT® EtherNet/IP MCA 121.
[7]	CANopen DSP 402	

8-13 Configurable Status Word STW		
This parameter enables configuration of bits 12–15 in the status word. Array [16]		
Option:	Function:	
[0]	No function	
[1] *	Profile Default	The function corresponds to the profile default selected in parameter 8-10 Control Profile.
[2]	Alarm 68 Only	Only set if alarm 68, Safe Torque Off occurs.
[3]	Trip excl Alarm 68	Set if a trip occurs, unless alarm 68, Safe Torque Off is set to execute the trip.
[10]	T18 DI status	The bit indicates the status of terminal 18.

8-13 Configurable Status Word STW		
This parameter enables configuration of bits 12–15 in the status word. Array [16]		
Option:	Function:	
		0 indicates that the terminal is low. 1 indicates that the terminal is high.
[11]	T19 DI status	The bit indicates the status of terminal 19. 0 indicates that the terminal is low. 1 indicates that the terminal is high.
[12]	T27 DI status	The bit indicates the status of terminal 27. 0 indicates that the terminal is low. 1 indicates that the terminal is high.
[13]	T29 DI status	The bit indicates the status of terminal 29. 0 indicates that the terminal is low. 1 indicates that the terminal is high.
[14]	T32 DI status	The bit indicates the status of terminal 32. 0 indicates that the terminal is low. 1 indicates that the terminal is high.
[15]	T33 DI status	The bit indicates the status of terminal 33. 0 indicates that the terminal is low. 1 indicates that the terminal is high.
[16]	T37 DI status	The bit indicates the status of terminal 37. 0 indicates that T37 is low (Safe Torque Off). 1 indicates that T37 is high (normal).
[20]	CTW Timeout Toggle Inverse	
[21]	Thermal warning	The thermal warning turns on when the temperature exceeds the limit in the motor, frequency converter, brake resistor, or thermistor.
[30]	Brake fault (IGBT)	Output is logic 1 when the brake IGBT is short-circuited. Use this function to protect the frequency converter if there is a fault on the brake modules. Use the output/relay to cut out the main voltage from the frequency converter.
[40]	Out of ref range	
[60]	Comparator 0	See parameter group 13-1* Comparators. If comparator 0 is evaluated as true, the output goes high. Otherwise, it is low.

8-13 Configurable Status Word STW		
This parameter enables configuration of bits 12–15 in the status word.		
Array [16]		
Option:	Function:	
[61]	Comparator 1	See <i>parameter group 13-1* Comparators</i> . If comparator 1 is evaluated as true, the output goes high. Otherwise, it is low.
[62]	Comparator 2	See <i>parameter group 13-1* Comparators</i> . If comparator 2 is evaluated as true, the output goes high. Otherwise, it is low.
[63]	Comparator 3	See <i>parameter group 13-1* Comparators</i> . If comparator 3 is evaluated as true, the output goes high. Otherwise, it is low.
[64]	Comparator 4	See <i>parameter group 13-1* Comparators</i> . If comparator 4 is evaluated as true, the output goes high. Otherwise, it is low.
[65]	Comparator 5	See <i>parameter group 13-1* Comparators</i> . If comparator 5 is evaluated as true, the output goes high. Otherwise, it is low.
[70]	Logic Rule 0	See <i>parameter group 13-4* Logic Rules</i> . If logic rule 0 is evaluated as true, the output goes high. Otherwise, it is low.
[71]	Logic Rule 1	See <i>parameter group 13-4* Logic Rules</i> . If logic rule 1 is evaluated as true, the output goes high. Otherwise, it is low.
[72]	Logic Rule 2	See <i>parameter group 13-4* Logic Rules</i> . If logic rule 2 is evaluated as true, the output goes high. Otherwise, it is low.
[73]	Logic Rule 3	See <i>parameter group 13-4* Logic Rules</i> . If logic rule 3 is evaluated as true, the output goes high. Otherwise, it is low.
[74]	Logic Rule 4	See <i>parameter group 13-4* Logic Rules</i> . If logic rule 4 is evaluated as true, the output goes high. Otherwise, it is low.
[75]	Logic Rule 5	See <i>parameter group 13-4* Logic Rules</i> . If logic rule 5 is evaluated as true, the output goes high. Otherwise, it is low.
[80]	SL digital out A	See <i>parameter 13-52 SL Controller Action</i> . The output goes high whenever the smart logic action [38] <i>Set digital out A high</i> is executed. The output goes low whenever the smart logic action [32] <i>Set digital out A low</i> is executed.
[81]	SL digital out B	See <i>parameter 13-52 SL Controller Action</i> . The output goes high whenever the smart logic action [39] <i>Set digital out B high</i> is executed. The output goes low

8-13 Configurable Status Word STW		
This parameter enables configuration of bits 12–15 in the status word.		
Array [16]		
Option:	Function:	
		whenever the smart logic action [33] <i>Set digital out B low</i> is executed.
[82]	SL digital out C	See <i>parameter 13-52 SL Controller Action</i> . The output goes high whenever the smart logic action [40] <i>Set digital out C high</i> is executed. The output goes low whenever the smart logic action [34] <i>Set digital out C low</i> is executed.
[83]	SL digital out D	See <i>parameter 13-52 SL Controller Action</i> . The output goes high whenever the smart logic action [41] <i>Set digital out D high</i> is executed. The output goes low whenever the smart logic action [35] <i>Set digital out D low</i> is executed.
[84]	SL digital out E	See <i>parameter 13-52 SL Controller Action</i> . The output goes high whenever the smart logic action [42] <i>Set digital out E high</i> is executed. The output goes low whenever the smart logic action [36] <i>Set digital out E low</i> is executed.
[85]	SL digital out F	See <i>parameter 13-52 SL Controller Action</i> . The output goes high whenever the smart logic action [43] <i>Set digital out F high</i> is executed. The output goes low whenever the smart logic action [37] <i>Set digital out F low</i> is executed.
[86]	ATEX ETR cur. alarm	
[87]	ATEX ETR freq. alarm	
[88]	ATEX ETR cur. warning	
[89]	ATEX ETR freq. warning	
[181]	Prev. Maintenance	
[182]	Deragging	
[183]	Post/Pre Lube	
[190]	No-Flow	
[191]	Dry Pump	
[192]	End Of Curve	
[193]	Sleep Mode	
[194]	Broken Belt	
[196]	Emergency Mode	
[197]	Emerg. Mode was Act.	

8-13 Configurable Status Word STW		
This parameter enables configuration of bits 12–15 in the status word.		
Array [16]		
Option:	Function:	
[199]	Pipe Filling	
[200]	User Defined Alerts	

8-14 Configurable Control Word CTW		
Array [15]		
Option:	Function:	
[0]	The frequency converter ignores the information in this bit.	
[1] *	The functionality of the bit depends on the selection parameter 8-10 Control Word Profile.	
[2]	If set to 1, the frequency converter ignores the remaining bits of the control word.	

8-17 Configurable Alarm and Warningword		
Array [16]		
Select the meaning of a specific bit in the configurable alarm and warning word. The word has 16 bits (0–15).		
Option:	Function:	
[0] *	Off	
[1]	10 Volts low warning	
[2]	Live zero warning	
[3]	No motor warning	
[4]	Mains phase loss warning	
[5]	DC link voltage high warning	
[6]	DC link voltage low warning	
[7]	DC overvoltage warning	
[8]	DC undervoltage warning	
[9]	Inverter overloaded warning	
[10]	Motor ETR overtemp warning	
[11]	Motor thermistor overtemp warning	
[12]	Torque limit warning	
[13]	Over current warning	
[14]	Earth fault warning	
[17]	Controlword timeout warning	
[19]	Discharge temp high warning	
[23]	Internal fans warning	
[24]	External fans warning	
[25]	Brake resistor short circuit warning	
[26]	Brake powerlimit warning	
[27]	Brake chopper short circuit warning	
[28]	Brake check warning	
[29]	Heatsink temperature warning	
[30]	Motor phase U warning	
[31]	Motor phase V warning	

8-17 Configurable Alarm and Warningword		
Array [16]		
Select the meaning of a specific bit in the configurable alarm and warning word. The word has 16 bits (0–15).		
Option:	Function:	
[32]	Motor phase W warning	
[34]	Fieldbus communication warning	
[36]	Mains failure warning	
[40]	T27 overload warning	
[41]	T29 overload warning	
[45]	Earth fault 2 warning	
[47]	24V supply low warning	
[58]	AMA internal fault warning	
[59]	Current limit warning	
[60]	External interlock warning	
[61]	Feedback error warning	
[62]	Frequency max warning	
[64]	Voltage limit warning	
[65]	Controlboard overtemp warning	
[66]	Heatsink temp low warning	
[68]	Safe stop warning	
[73]	Safe stop autorestart warning	
[76]	Power unit setup warning	
[77]	Reduced powermode warning	
[163]	ATEX ETR cur limit warning	
[165]	ATEX ETR freq limit warning	
[10002]	Live zero error alarm	
[10004]	Mains phase loss alarm	
[10007]	DC overvoltage alarm	
[10008]	DC undervoltage alarm	
[10009]	Inverter overload alarm	
[10010]	ETR overtemperature alarm	
[10011]	Thermistor overtemp alarm	
[10012]	Torque limit alarm	
[10013]	Overcurrent alarm	
[10014]	Earth fault alarm	
[10016]	Short circuit alarm	
[10017]	CTW timeout alarm	
[10026]	Brake powerlimit alarm	
[10027]	Brakechopper shortcircuit alarm	
[10028]	Brake check alarm	
[10029]	Heatsink temp alarm	
[10030]	Phase U missing alarm	
[10031]	Phase V missing alarm	
[10032]	Phase W missing alarm	
[10033]	Inrush fault alarm	
[10034]	Fieldbus com faul alarm	
[10036]	Mains failure alarm	
[10037]	Phase imbalance alarm	
[10038]	Internal fault	
[10039]	Heatsink sensor alarm	

8-17 Configurable Alarm and Warningword		
Array [16] Select the meaning of a specific bit in the configurable alarm and warning word. The word has 16 bits (0–15).		
Option:		Function:
[10045]	Earth fault 2 alarm	
[10046]	Powercard supply alarm	
[10047]	24V supply low alarm	
[10048]	1.8V supply low alarm	
[10049]	Speed limit alarm	
[10060]	Ext interlock alarm	
[10061]	Feedback error alarm	
[10063]	Mech brake low alarm	
[10065]	Controlboard overtemp alarm	
[10067]	Option config changed alarm	
[10068]	Safe stop alarm	
[10069]	Powercard temp alarm	
[10073]	Safestop auto restart alarm	
[10074]	PTC thermistor alarm	
[10079]	Illegal PS config alarm	
[10081]	CSIV corrupt alarm	
[10082]	CSIV param error alarm	
[10090]	Feedback monitor alarm	
[10091]	AI54 settings alarm	
[10164]	ATEX ETR current lim alarm	
[10166]	ATEX ETR freq limit alarm	

3.9.3 8-3* FC Port Settings

8-30 Protocol		
Option:	Function:	
		Protocol selection for the integrated FC (standard) port (RS485) on the control card.
[0]	FC	Communication according to the FC protocol as described in <i>RS485 Installation and Set-up</i> in the relevant <i>design guide</i> .
[1]	FC MC	Same as [0] FC but to be used when downloading SW to the frequency converter or uploading dll file (covering information regarding parameters available in the frequency converter and their inter-dependencies) to MCT 10 Set-up Software.
[2]	Modbus RTU	Communication according to the Modbus RTU protocol.
[3]	Metasys N2	
[9]	FC Option	
[22]	Modbus CASCADE Master	Enables cascade 2.0 master capability. Sets <i>parameter 8-32 Baud Rate</i> to choice 19200. For more information, refer to <i>chapter 3.24.1 Introduction</i> .

8-31 Address		
Range:	Function:	
Size related*	[1 - 255]	Enter the address for the frequency converter (standard) port. Valid range: Depends on selected protocol.

8-32 Baud Rate		
Baud rates 9600, 19200, 38400, and 76800 are valid for BACnet only. The default value depends on the FC protocol.		
Option:	Function:	
[0]	2400 Baud	
[1]	4800 Baud	
[2]	9600 Baud	
[3]	19200 Baud	
[4]	38400 Baud	
[5]	57600 Baud	
[6]	76800 Baud	
[7]	115200 Baud	

8-33 Parity / Stop Bits		
Parity and stop bits for the protocol <i>parameter 8-30 Protocol</i> using the FC port. For some of the protocols, not all options are visible. Default depends on the protocol selected.		
Option:	Function:	
[0]	Even Parity, 1 Stop Bit	
[1]	Odd Parity, 1 Stop Bit	
[2]	No Parity, 1 Stop Bit	
[3]	No Parity, 2 Stop Bits	

8-35 Minimum Response Delay		
Range:	Function:	
10 ms*	[5 - 10000 ms]	Specify the minimum delay time between receiving a request and transmitting a response. This is used for overcoming modem turnaround delays.
Size related*	[5 - 10000 ms]	Specify the minimum delay time between receiving a request and transmitting a response. This is used for overcoming modem turnaround delays.

8-36 Max Response Delay		
Range:	Function:	
Size related*	[11 - 10001 ms]	Specify the maximum allowed delay time between transmitting a request and receiving a response. Exceeding this delay time causes control word timeout.

8-37 Maximum Inter-Char Delay		
Range:		Function:
Size related*	[0.00 - 35.01 ms]	Specify the maximum allowed time interval between receipt of 2 bytes. This parameter activates timeout if transmission is interrupted.

3.9.4 8-4* Telegram Selection

8-40 Telegram Selection		
Enables use of freely configurable telegrams or standard telegrams for the FC port.		
Option:		Function:
[1] *	Standard telegram 1	
[100]	None	
[101]	PPO 1	
[102]	PPO 2	
[103]	PPO 3	
[104]	PPO 4	
[105]	PPO 5	
[106]	PPO 6	
[107]	PPO 7	
[108]	PPO 8	
[200]	Custom telegram 1	
[202]	Custom telegram 3	

8-42 PCD Write Configuration		
Array [64]		
Option:		Function:
[0]	None	Select the parameters to be assigned to PCD telegrams. The number of available PCDs depends on the telegram type. The values in PCDs are then written to the selected parameters as data values.
[302]	Minimum Reference	
[303]	Maximum Reference	
[341]	Ramp 1 Ramp Up Time	
[342]	Ramp 1 Ramp Down Time	
[351]	Ramp 2 Ramp Up Time	
[352]	Ramp 2 Ramp Down Time	
[380]	Jog Ramp Time	
[381]	Quick Stop Ramp Time	
[411]	Motor Speed Low Limit [RPM]	
[412]	Motor Speed Low Limit [Hz]	
[413]	Motor Speed High Limit [RPM]	

8-42 PCD Write Configuration		
Array [64]		
Option:		Function:
[414]	Motor Speed High Limit [Hz]	
[416]	Torque Limit Motor Mode	
[417]	Torque Limit Generator Mode	
[553]	Term. 29 High Ref./Feedb. Value	
[558]	Term. 33 High Ref./Feedb. Value	
[590]	Digital & Relay Bus Control	
[593]	Pulse Out #27 Bus Control	
[595]	Pulse Out #29 Bus Control	
[597]	Pulse Out #X30/6 Bus Control	
[615]	Terminal 53 High Ref./Feedb. Value	
[625]	Terminal 54 High Ref./Feedb. Value	
[653]	Terminal 42 Output Bus Control	
[663]	Terminal X30/8 Output Bus Control	
[673]	Terminal X45/1 Bus Control	
[683]	Terminal X45/3 Bus Control	
[894]	Bus Feedback 1	
[895]	Bus Feedback 2	
[896]	Bus Feedback 3	
[1680]	Fieldbus CTW 1	
[1682]	Fieldbus REF 1	
[1685]	FC Port CTW 1	
[1686]	FC Port REF 1	
[2021]	Setpoint 1	
[2022]	Setpoint 2	
[2023]	Setpoint 3	
[2643]	Terminal X42/7 Bus Control	
[2653]	Terminal X42/9 Bus Control	
[2663]	Terminal X42/11 Bus Control	
[3401]	PCD 1 Write to MCO	
[3402]	PCD 2 Write to MCO	
[3403]	PCD 3 Write to MCO	
[3404]	PCD 4 Write to MCO	
[3405]	PCD 5 Write to MCO	
[3406]	PCD 6 Write to MCO	
[3407]	PCD 7 Write to MCO	
[3408]	PCD 8 Write to MCO	
[3409]	PCD 9 Write to MCO	
[3410]	PCD 10 Write to MCO	

8-43 PCD Read Configuration		
Array [64]		
Option:		Function:
[0]	None	Select the parameters to be assigned to PCDs of the telegrams. The number of available PCDs depends on the telegram type. PCDs contain the

8-43 PCD Read Configuration		
Array [64]		
Option:		Function:
		actual data values of the selected parameters.
[15]	Readout: actual setup	
[894]	Bus Feedback 1	
[895]	Bus Feedback 2	
[896]	Bus Feedback 3	
[1397]	Alert Alarm Word	
[1398]	Alert Warning Word	
[1399]	Alert Status Word	
[1500]	Operating hours	
[1501]	Running Hours	
[1502]	kWh Counter	
[1600]	Control Word	
[1601]	Reference [Unit]	
[1602]	Reference [%]	
[1603]	Status Word	
[1605]	Main Actual Value [%]	
[1609]	Custom Readout	
[1610]	Power [kW]	
[1611]	Power [hp]	
[1612]	Motor Voltage	
[1613]	Frequency	
[1614]	Motor current	
[1615]	Frequency [%]	
[1616]	Torque [Nm]	
[1617]	Speed [RPM]	
[1618]	Motor Thermal	
[1619]	Thermistor Sensor Temperature	
[1622]	Torque [%]	
[1623]	Motor Shaft Power [kW]	Shows the mechanical power applied to the motor shaft.
[1624]	Calibrated Stator Resistance	
[1626]	Power Filtered [kW]	
[1627]	Power Filtered [hp]	
[1630]	DC Link Voltage	
[1632]	Brake Energy /s	
[1633]	Brake Energy Average	
[1634]	Heatsink Temp.	
[1635]	Inverter Thermal	
[1638]	SL Controller State	
[1639]	Control Card Temp.	
[1642]	Service Log Counter	
[1645]	Motor Phase U Current	
[1646]	Motor Phase V Current	
[1647]	Motor Phase W Current	
[1650]	External Reference	

8-43 PCD Read Configuration		
Array [64]		
Option:		Function:
[1652]	Feedback[Unit]	
[1653]	Digi Pot Reference	
[1654]	Feedback 1 [Unit]	
[1655]	Feedback 2 [Unit]	
[1656]	Feedback 3 [Unit]	
[1660]	Digital Input	
[1661]	Terminal 53 Switch Setting	
[1662]	Analog Input 53	
[1663]	Terminal 54 Switch Setting	
[1664]	Analog Input 54	
[1665]	Analog Output 42 [mA]	
[1666]	Digital Output [bin]	
[1667]	Pulse Input #29 [Hz]	
[1668]	Pulse Input #33 [Hz]	
[1669]	Pulse Output #27 [Hz]	
[1670]	Pulse Output #29 [Hz]	
[1671]	Relay Output [bin]	
[1672]	Counter A	
[1673]	Counter B	
[1675]	Analog In X30/11	
[1676]	Analog In X30/12	
[1677]	Analog Out X30/8 [mA]	
[1678]	Analog Out X45/1 [mA]	
[1679]	Analog Out X45/3 [mA]	
[1684]	Comm. Option STW	
[1687]	Bus Readout Alarm/Warning	
[1689]	Configurable Alarm/Warning Word	Shows the alarm/warning word that is configured in <i>parameter 8-17 Configurable Alarm and Warningword.</i>
[1690]	Alarm Word	
[1691]	Alarm Word 2	
[1692]	Warning Word	
[1693]	Warning Word 2	
[1694]	Ext. Status Word	
[1695]	Ext. Status Word 2	
[1696]	Maintenance Word	
[1697]	Alarm Word 3	
[1698]	Warning Word 3	
[1830]	Analog Input X42/1	
[1831]	Analog Input X42/3	
[1832]	Analog Input X42/5	
[1833]	Analog Out X42/7 [V]	
[1834]	Analog Out X42/9 [V]	
[1835]	Analog Out X42/11 [V]	
[1836]	Analog Input X48/2 [mA]	
[1837]	Temp. Input X48/4	

8-43 PCD Read Configuration		
Array [64]		
Option:	Function:	
[1838]	Temp. Input X48/7	
[1839]	Temp. Input X48/10	
[1850]	Sensorless Readout [unit]	
[1860]	Digital Input 2	
[2792]	% Of Total Capacity	
[2795]	Advanced Cascade Relay Output [bin]	
[2796]	Extended Cascade Relay Output [bin]	
[2969]	Flow	
[3421]	PCD 1 Read from MCO	
[3422]	PCD 2 Read from MCO	
[3423]	PCD 3 Read from MCO	
[3424]	PCD 4 Read from MCO	
[3425]	PCD 5 Read from MCO	
[3426]	PCD 6 Read from MCO	
[3427]	PCD 7 Read from MCO	
[3428]	PCD 8 Read from MCO	
[3429]	PCD 9 Read from MCO	
[3430]	PCD 10 Read from MCO	

3.9.5 8-5* Digital/Bus

Parameters for configuring the control word merging.

NOTICE!

These parameters are active only when parameter 8-01 Control Site is set to [0] Digital and control word.

8-50 Coasting Select		
Select the trigger for the coasting function.		
Option:	Function:	
[0]	Digital input	A digital input triggers the coasting function.
[1]	Bus	A serial communication port or the fieldbus triggers the coasting function.
[2]	Logic AND	The fieldbus/serial communication port and a digital input trigger the coasting function.
[3] *	Logic OR	The fieldbus/serial communication port or a digital input triggers the coasting function.

8-52 DC Brake Select		
Option:	Function:	
		Select control of the DC brake via the terminals (digital input) and/or via the fieldbus.

8-52 DC Brake Select		
Option:	Function:	
		NOTICE! Only selection [0] Digital Input is available when parameter 1-10 Motor Construction is set to [1] PM, non-salient SPM.
[0]	Digital input	Activates start command via a digital input.
[1]	Bus	Activates start command via the serial communication port or fieldbus option.
[2]	Logic AND	Activates start command via the fieldbus/serial communication port AND via 1 of the digital inputs.
[3]	Logic OR	Activates start command via the fieldbus/serial communication port OR via 1 of the digital inputs.

8-53 Start Select		
Select the trigger for the start function.		
Option:	Function:	
[0]	Digital input	A digital input triggers the start function.
[1]	Bus	A serial communication port or the fieldbus triggers the start function.
[2]	Logic AND	The fieldbus/serial communication port and a digital input trigger the start function.
[3] *	Logic OR	The fieldbus/serial communication port or a digital input triggers the start function.

8-54 Reversing Select		
Select control of the frequency converter reverse function via the terminals (digital input) and/or via the fieldbus.		
Option:	Function:	
		NOTICE! This parameter is active only when parameter 8-01 Control Site is set to [0] Digital and control word.
[0] *	Digital input	Activates reverse command via a digital input.
[1]	Bus	Activates reverse command via the serial communication port or fieldbus option.
[2]	Logic AND	Activates reverse command via the fieldbus/serial communication port and via 1 of the digital inputs.
[3]	Logic OR	Activates reverse command via the fieldbus/serial communication port or via 1 of the digital inputs.

8-55 Set-up Select		
Select the trigger for the set-up selection.		
Option:	Function:	
[0]	Digital input	A digital input triggers the set-up selection.
[1]	Bus	A serial communication port or the fieldbus triggers the set-up selection.
[2]	Logic AND	The fieldbus/serial communication port and a digital input trigger the set-up selection.
[3] *	Logic OR	The fieldbus/serial communication port or a digital input triggers the set-up selection.

8-56 Preset Reference Select		
Option:	Function:	
		Select the trigger for the preset reference selection.
[0]	Digital input	A digital input triggers the preset reference selection.
[1]	Bus	A serial communication port or the fieldbus triggers the preset reference selection.
[2]	Logic AND	The fieldbus/serial communication port and a digital input trigger the preset reference selection.
[3] *	Logic OR	The fieldbus/serial communication port or a digital input triggers the preset reference selection.

3.9.6 8-8* FC Port Diagnostics

These parameters are used for monitoring the bus communication via the frequency converter port.

8-80 Bus Message Count		
Range:	Function:	
0*	[0 - 4294967295]	This parameter shows the number of valid telegrams detected on the bus.

8-81 Bus Error Count		
Array [6]		
Range:	Function:	
0*	[0 - 4294967295]	This parameter shows the number of telegrams with faults (for example CRC fault) detected on the bus.

8-82 Slave Message Rcvd		
Range:	Function:	
0*	[0 - 4294967295]	This parameter shows the number of valid telegrams addressed to the slave sent by the frequency converter.

8-83 Slave Error Count		
Range:	Function:	
0*	[0 - 4294967295]	This parameter shows the number of error telegrams, which are not executed by the frequency converter.

3.9.7 8-9* Bus Jog

8-94 Bus Feedback 1		
Range:	Function:	
0*	[-200 - 200]	Write feedback to this parameter via the serial communication port or fieldbus option. Select this parameter as a feedback source in <i>parameter 20-00 Feedback 1 Source</i> , <i>parameter 20-03 Feedback 2 Source</i> , or <i>parameter 20-06 Feedback 3 Source</i> .

8-95 Bus Feedback 2		
Range:	Function:	
0*	[-200 - 200]	See <i>parameter 8-94 Bus Feedback 1</i> for further details.

8-96 Bus Feedback 3		
Range:	Function:	
0*	[-200 - 200]	See <i>parameter 8-94 Bus Feedback 1</i> for further details.

8-97 Response Error Codes		
Range:	Function:	
0*	[0 - 0]	

3.10 Parameters 9-** PROFIBUS

For PROFIBUS parameter descriptions, see the VLT® PROFIBUS DP MCA 101 Programming Guide.

3.11 Parameters 10-** CAN Fieldbus

3.11.1 10-0* Common Settings

10-00 CAN Protocol		
Option:	Function:	
[1] *	DeviceNet	<p>NOTICE!</p> <p>The parameter options depend on installed option.</p> <p>View the active CAN protocol.</p>

10-01 Baud Rate Select		
Option:	Function:	
		Select the fieldbus transmission speed. The selection must correspond to the transmission speed of the master and the other fieldbus nodes.
[16]	10 Kbps	
[17]	20 Kbps	
[18]	50 Kbps	
[19]	100 Kbps	
[20]	125 Kbps	
[21]	250 Kbps	
[22]	500 Kbps	
[23]	800 Kbps	
[24]	1000 Kbps	

10-02 MAC ID		
Range:	Function:	
Size related*	[0 - 63]	Selection of station address. Every station connected to the same DeviceNet network must have an unambiguous address.

10-05 Readout Transmit Error Counter		
Range:	Function:	
0*	[0 - 255]	Shows the number of CAN control transmission errors since the last power-up.

10-06 Readout Receive Error Counter		
Range:	Function:	
0*	[0 - 255]	Shows the number of CAN control receipt errors since the last power-up.

10-07 Readout Bus Off Counter		
Range:	Function:	
0*	[0 - 255]	View the number of fieldbus off events since the last power-up.

3.11.2 10-1* DeviceNet

10-10 Process Data Type Selection		
Option:	Function:	
		<p>Select the instance (telegram) for data transmission. The instances available depend on the setting of <i>parameter 8-10 Control Profile</i>.</p> <p>When <i>parameter 8-10 Control Profile</i> is set to [0] FC profile, <i>parameter 10-10 Process Data Type Selection</i> options [0] INSTANCE 100/150 and [1] INSTANCE 101/151 are available.</p> <p>When <i>parameter 8-10 Control Profile</i> is set to [5] ODVA, <i>parameter 10-10 Process Data Type Selection</i> options [2] INSTANCE 20/70 and [3] INSTANCE 21/71 are available.</p> <p>Instances 100/150 and 101/151 are Danfoss-specific. Instances 20/70 and 21/71 are ODVA-specific AC motor profiles.</p> <p>For guidelines in telegram selection, refer to the <i>VLT® DeviceNet MCA 104 Installation Guide</i>.</p> <p>NOTICE!</p> <p>A change to this parameter is executed immediately.</p>
[0]	INSTANCE 100/150	
[1]	INSTANCE 101/151	
[2]	INSTANCE 20/70	
[3]	INSTANCE 21/71	
[6]	INSTANCE 102/152	

10-11 Process Data Config Write		
Option:	Function:	
		Select the process write data for I/O assembly instances 101/151. Elements 2 and 3 of this array can be selected. Elements 0 and 1 of the array are fixed.
[0]	None	
[302]	Minimum Reference	
[303]	Maximum Reference	
[341]	Ramp 1 Ramp Up Time	
[342]	Ramp 1 Ramp Down Time	
[351]	Ramp 2 Ramp Up Time	

10-11 Process Data Config Write		
Option:	Function:	
[352]	Ramp 2 Ramp Down Time	
[380]	Jog Ramp Time	
[381]	Quick Stop Ramp Time	
[411]	Motor Speed Low Limit [RPM]	
[412]	Motor Speed Low Limit [Hz]	
[413]	Motor Speed High Limit [RPM]	
[414]	Motor Speed High Limit [Hz]	
[416]	Torque Limit Motor Mode	
[417]	Torque Limit Generator Mode	
[553]	Term. 29 High Ref./Feedb. Value	
[558]	Term. 33 High Ref./Feedb. Value	
[590]	Digital & Relay Bus Control	
[593]	Pulse Out #27 Bus Control	
[595]	Pulse Out #29 Bus Control	
[597]	Pulse Out #X30/6 Bus Control	
[615]	Terminal 53 High Ref./Feedb. Value	
[625]	Terminal 54 High Ref./Feedb. Value	
[653]	Terminal 42 Output Bus Control	
[663]	Terminal X30/8 Output Bus Control	
[673]	Terminal X45/1 Bus Control	
[683]	Terminal X45/3 Bus Control	
[894]	Bus Feedback 1	
[895]	Bus Feedback 2	
[896]	Bus Feedback 3	
[1680]	Fieldbus CTW 1	
[1682]	Fieldbus REF 1	
[1685]	FC Port CTW 1	
[1686]	FC Port REF 1	

10-12 Process Data Config Read

Option:	Function:
	Select the process read data for I/O assembly instances 101/151. Elements 2 and 3 of this array can be selected. Elements 0 and 1 of the array are fixed.

10-13 Warning Parameter

Range:	Function:
0* [0 - 65535]	View a DeviceNet-specific warning word. One bit is assigned to every warning. Refer to the <i>VLT® MCA 104 DeviceNet Installation Guide</i> for further information.

Bit	Description
0	Bus not active.
1	Explicit connection timeout.
2	I/O connection.
3	Retry limit reached.
4	Actual is not updated.
5	CAN bus off.

Bit	Description
6	I/O send error.
7	Initialization error.
8	No bus supply.
9	Bus off.
10	Error passive.
11	Error warning.
12	Duplicate MAC ID error.
13	RX queue overrun.
14	TX queue overrun.
15	CAN overrun.

Table 3.20 Warning Bits

10-14 Net Reference

Option:	Function:
	Select the reference source in instances 21/71 and 20/70.
[0] *	Off Enables reference via analog/digital inputs.
[1]	On Enables reference via the fieldbus.

10-15 Net Control

Option:	Function:
	Select the control source in instances 21/71 and 20/70.
[0] *	Off Enables control via analog/digital inputs.
[1]	On Enable control via the fieldbus.

3.11.3 10-2* COS Filters

10-20 COS Filter 1

Range:	Function:
0* [0 - 65535]	Enter the value for COS filter 1 to set up the filter mask for the status word. When operating in COS (change-of-state), this function filters out bits in the status word that should not be sent if they change.

10-21 COS Filter 2

Range:	Function:
0* [0 - 65535]	Enter the value for COS filter 2 to set up the filter mask for the Main Actual Value. When operating in COS, this function filters out bits in the main actual value that should not be sent if they change.

10-22 COS Filter 3		
Range:		Function:
0*	[0 - 65535]	Enter the value for COS filter 3 to set up the filter mask for PCD 3. When operating in COS, this function filters out bits in PCD 3 that should not be sent if they change.

10-23 COS Filter 4		
Range:		Function:
0*	[0 - 65535]	Enter the value for COS filter 4 to set up the filter mask for PCD 4. When operating in COS, this function filters out bits in PCD 4 that should not be sent if they change.

3.11.4 10-3* Parameter Access

Parameter group providing access to indexed parameters and defining programming set-up.

10-30 Array Index		
Range:		Function:
0*	[0 - 255]	View array parameters. This parameter is valid only when a VLT® DeviceNet MCA 104 is installed.

10-31 Store Data Values		
Option:		Function:
		Parameter values changed via DeviceNet are not automatically stored in non-volatile memory. Use this parameter to activate a function that stores parameter values in the EEPROM non-volatile memory, so changed parameter values are retained at power-down.
[0] *	Off	Deactivates the non-volatile storage function.
[1]	Store edit setup	Stores all parameter values from the active set-up in the non-volatile memory. The selection returns to [0] Off when all values have been stored.
[2]	Store all setups	Stores all parameter values for all set-ups in the non-volatile memory. The selection returns to [0] Off when all parameter values have been stored.

10-32 Devicenet Revision		
Range:		Function:
Size related*	[0 - 65535]	View the DeviceNet revision number. This parameter is used for EDS file creation.

10-33 Store Always		
Option:		Function:
[0] *	Off	Deactivates non-volatile storage of data.
[1]	On	Stores parameter data received via VLT® DeviceNet MCA 104 in EEPROM non-volatile memory as default.

10-34 DeviceNet Product Code		
Range:		Function:
0 N/A*	[0 - 65535 N/A]	

10-39 Devicenet F Parameters		
Array [1000]. No LCP access.		
Range:		Function:
0*	[0 - 0]	This parameter is used to configure the frequency converter via VLT® DeviceNet MCA 104 and to build the EDS file.

3.12 Parameters 13-** Smart Logic

Smart logic control (SLC) is essentially a sequence of user-defined actions (see *parameter 13-52 SL Controller Action [x]*) executed by the SLC when the associated user-defined event (see *parameter 13-51 SL Controller Event [x]*) is evaluated as true by the SLC. Events and actions are each numbered and linked in pairs. This means that when the 1st event is fulfilled (attains the value TRUE), the 1st action is executed. After this, the 2nd event is evaluated and if evaluated true, the 2nd action is executed, and so on. Only 1 event is evaluated at any time. If an event is evaluated as false, nothing happens (in the SLC) during the current scan interval and no other events are evaluated. This means that when the SLC starts, it evaluates the 1st event (and only the 1st event) in each scan interval. Only when the 1st event is evaluated true, the SLC executes the 1st action and starts evaluating the 2nd event. It is possible to program from 1–20 events and actions.

When the last event/action has been executed, the sequence starts over again from the 1st event/the 1st action. *Figure 3.40* shows an example with 3 events/actions.

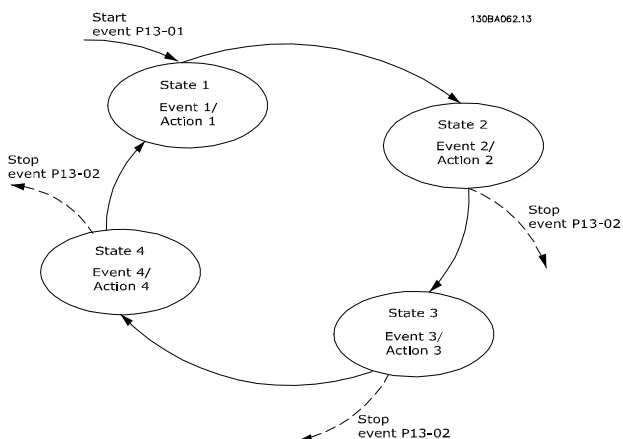

Figure 3.40 Smart Logic Event Actions

Starting and stopping the SLC

Starting and stopping the SLC can be done by selecting [1] On or [0] Off in *parameter 13-00 SL Controller Mode*. The SLC always starts in state 0 (where it evaluates the first event). The SLC starts when the start event (defined in *parameter 13-01 Start Event*) is evaluated as true (if [1] On is selected in *parameter 13-00 SL Controller Mode*). The SLC stops when the stop event (*parameter 13-02 Stop Event*) is true. *Parameter 13-03 Reset SLC* resets all SLC parameters and starts programming from scratch.

3.12.1 13-0* SLC Settings

Use the SLC settings to activate, deactivate, and reset the smart logic control sequence. The logic functions and comparators are always running in the background, which opens for separate control of digital inputs and outputs.

13-00 SL Controller Mode		
Option:	Function:	
[0]	Off	Disables the smart logic controller.
[1]	On	Enables the smart logic controller.

13-01 Start Event		
Option:	Function:	
		Select the boolean (true or false) input to activate smart logic control.
[0]	False	Enters the fixed value of false in the logic rule.
[1]	True	Enters the fixed value of true in the logic rule.
[2]	Running	See <i>parameter group 5-3* Digital Outputs</i> for further description.
[3]	In range	See <i>parameter group 5-3* Digital Outputs</i> for further description.
[4]	On reference	See <i>parameter group 5-3* Digital Outputs</i> for further description.
[5]	Torque limit	See <i>parameter group 5-3* Digital Outputs</i> for further description.
[6]	Current Limit	See <i>parameter group 5-3* Digital Outputs</i> for further description.
[7]	Out of current range	See <i>parameter group 5-3* Digital Outputs</i> for further description.
[8]	Below I low	See <i>parameter group 5-3* Digital Outputs</i> for further description.
[9]	Above I high	See <i>parameter group 5-3* Digital Outputs</i> for further description.
[10]	Out of speed range	
[11]	Below speed low	See <i>parameter group 5-3* Digital Outputs</i> for further description.
[12]	Above speed high	See <i>parameter group 5-3* Digital Outputs</i> for further description.
[13]	Out of feedb. range	
[14]	Below feedb. low	
[15]	Above feedb. high	

13-01 Start Event		
Option:	Function:	
[16]	Thermal warning	See <i>parameter group 5-3* Digital Outputs</i> for further description.
[17]	Mains out of range	See <i>parameter group 5-3* Digital Outputs</i> for further description.
[18]	Reversing	See <i>parameter group 5-3* Digital Outputs</i> for further description.
[19]	Warning	See <i>parameter group 5-3* Digital Outputs</i> for further description.
[20]	Alarm (trip)	See <i>parameter group 5-3* Digital Outputs</i> for further description.
[21]	Alarm (trip lock)	See <i>parameter group 5-3* Digital Outputs</i> for further description.
[22]	Comparator 0	Use the result of comparator 0 in the logic rule.
[23]	Comparator 1	Use the result of comparator 1 in the logic rule.
[24]	Comparator 2	Use the result of comparator 2 in the logic rule.
[25]	Comparator 3	Use the result of comparator 3 in the logic rule.
[26]	Logic rule 0	Use the result of logic rule 0 in the logic rule.
[27]	Logic rule 1	Use the result of logic rule 1 in the logic rule.
[28]	Logic rule 2	Use the result of logic rule 2 in the logic rule.
[29]	Logic rule 3	Use the result of logic rule 3 in the logic rule.
[33]	Digital input DI18	Use the value of DI18 in the logic rule (High = true).
[34]	Digital input DI19	Use the value of DI19 in the logic rule (High = true).
[35]	Digital input DI27	Use the value of DI27 in the logic rule (High = true).
[36]	Digital input DI29	Use the value of DI29 in the logic rule (High = true).
[37]	Digital input DI32	Use the value of DI32 in the logic rule (High = true).
[38]	Digital input DI33	Use the value of DI33 in the logic rule (High = true).
[39]	Start command	This event is true if the frequency converter is started (either via digital input, fieldbus, or other).

13-01 Start Event		
Option:	Function:	
[40]	Drive stopped	This event is true if the frequency converter is stopped or coasted (either via digital input, fieldbus, or other).
[41]	Reset Trip	This event is true if the frequency converter is tripped (but not trip-locked) and [Reset] is pressed.
[42]	Auto Reset Trip	This event is true if the frequency converter is tripped (but not trip-locked) and an automatic reset is issued.
[43]	OK Key	This event is true if [OK] is pressed.
[44]	Reset Key	This event is true if [Reset] is pressed.
[45]	Left Key	This event is true if [◀] is pressed.
[46]	Right Key	This event is true if [▶] is pressed.
[47]	Up Key	This event is true if [▲] is pressed.
[48]	Down Key	This event is true if [▼] is pressed.
[50]	Comparator 4	Use the result of comparator 4 in the logic rule.
[51]	Comparator 5	Use the result of comparator 5 in the logic rule.
[60]	Logic rule 4	Use the result of logic rule 4 in the logic rule.
[61]	Logic rule 5	Use the result of logic rule 5 in the logic rule.
[76]	Digital input x30/2	
[77]	Digital input x30/3	
[78]	Digital input x30/4	
[90]	ECB Drive Mode	
[91]	ECB Bypass Mode	
[92]	ECB Test Mode	
[94]	RS Flipflop 0	
[95]	RS Flipflop 1	
[96]	RS Flipflop 2	
[97]	RS Flipflop 3	
[98]	RS Flipflop 4	
[99]	RS Flipflop 5	
[100]	RS Flipflop 6	See <i>parameter 13-15 RS-FF Operand S</i> , <i>parameter 13-16 RS-FF Operand R</i> .
[101]	RS Flipflop 7	
[102]	Verifying Flow	
[125]	Digital input x46/1	

13-01 Start Event		
Option:	Function:	
[126]	Digital input x46/3	
[127]	Digital input x46/5	
[128]	Digital input x46/7	
[129]	Digital input x46/9	
[130]	Digital input x46/11	
[131]	Digital input x46/13	

13-02 Stop Event		
Option:	Function:	
		Select the boolean (true or false) input to deactivate smart logic control.
[0]	False	Enters the fixed value of false in the logic rule.
[1]	True	Enters the fixed value of true in the logic rule.
[2]	Running	See <i>parameter group 5-3* Digital Outputs</i> for further description.
[3]	In range	See <i>parameter group 5-3* Digital Outputs</i> for further description.
[4]	On reference	See <i>parameter group 5-3* Digital Outputs</i> for further description.
[5]	Torque limit	See <i>parameter group 5-3* Digital Outputs</i> for further description.
[6]	Current Limit	See <i>parameter group 5-3* Digital Outputs</i> for further description.
[7]	Out of current range	See <i>parameter group 5-3* Digital Outputs</i> for further description.
[8]	Below I low	See <i>parameter group 5-3* Digital Outputs</i> for further description.
[9]	Above I high	See <i>parameter group 5-3* Digital Outputs</i> for further description.
[10]	Out of speed range	
[11]	Below speed low	See <i>parameter group 5-3* Digital Outputs</i> for further description.
[12]	Above speed high	See <i>parameter group 5-3* Digital Outputs</i> for further description.
[13]	Out of feedb. range	See <i>parameter group 5-3* Digital Outputs</i> for further description.

13-02 Stop Event		
Option:	Function:	
[14]	Below feedb. low	See <i>parameter group 5-3* Digital Outputs</i> for further description.
[15]	Above feedb. high	See <i>parameter group 5-3* Digital Outputs</i> for further description.
[16]	Thermal warning	See <i>parameter group 5-3* Digital Outputs</i> for further description.
[17]	Mains out of range	See <i>parameter group 5-3* Digital Outputs</i> for further description.
[18]	Reversing	See <i>parameter group 5-3* Digital Outputs</i> for further description.
[19]	Warning	See <i>parameter group 5-3* Digital Outputs</i> for further description.
[20]	Alarm (trip)	See <i>parameter group 5-3* Digital Outputs</i> for further description.
[21]	Alarm (trip lock)	See <i>parameter group 5-3* Digital Outputs</i> for further description.
[22]	Comparator 0	Use the result of comparator 0 in the logic rule.
[23]	Comparator 1	Use the result of comparator 1 in the logic rule.
[24]	Comparator 2	Use the result of comparator 2 in the logic rule.
[25]	Comparator 3	Use the result of comparator 3 in the logic rule.
[26]	Logic rule 0	Use the result of logic rule 0 in the logic rule.
[27]	Logic rule 1	Use the result of logic rule 1 in the logic rule.
[28]	Logic rule 2	Use the result of logic rule 2 in the logic rule.
[29]	Logic rule 3	Use the result of logic rule 3 in the logic rule.
[30]	SL Time-out 0	Use the result of timer 0 in the logic rule.
[31]	SL Time-out 1	Use the result of timer 1 in the logic rule.
[32]	SL Time-out 2	Use the result of timer 2 in the logic rule.
[33]	Digital input DI18	Use the value of DI18 in the logic rule (High = true).
[34]	Digital input DI19	Use the value of DI19 in the logic rule (High = true).
[35]	Digital input DI27	Use the value of DI27 in the logic rule (High = true).

13-02 Stop Event		
Option:	Function:	
[36]	Digital input DI29	Use the value of DI29 in the logic rule (High = true).
[37]	Digital input DI32	Use the value of DI32 in the logic rule (High = true).
[38]	Digital input DI33	Use the value of DI33 in the logic rule (High = true).
[39]	Start command	This event is true if the frequency converter is started (either via digital input, fieldbus or other).
[40]	Drive stopped	This event is true if the frequency converter is stopped or coasted (either via digital input, fieldbus or other).
[41]	Reset Trip	This event is true if the frequency converter is tripped (but not trip-locked) and [Reset] is pressed.
[42]	Auto Reset Trip	This event is true if the frequency converter is tripped (but not trip-locked) and an automatic reset is issued.
[43]	OK Key	This event is true if [OK] is pressed.
[44]	Reset Key	This event is true if [Reset] is pressed.
[45]	Left Key	This event is true if [◀] is pressed.
[46]	Right Key	This event is true if [▶] is pressed.
[47]	Up Key	This event is true if [▲] is pressed.
[48]	Down Key	This event is true if [▼] is pressed.
[50]	Comparator 4	Use the result of comparator 4 in the logic rule.
[51]	Comparator 5	Use the result of comparator 5 in the logic rule.
[60]	Logic rule 4	Use the result of logic rule 4 in the logic rule.
[61]	Logic rule 5	Use the result of logic rule 5 in the logic rule.
[70]	SL Time-out 3	Use the result of timer 3 in the logic rule.
[71]	SL Time-out 4	Use the result of timer 4 in the logic rule.
[72]	SL Time-out 5	Use the result of timer 5 in the logic rule.
[73]	SL Time-out 6	Use the result of timer 6 in the logic rule.
[74]	SL Time-out 7	Use the result of timer 7 in the logic rule.

13-02 Stop Event		
Option:	Function:	
[75]	Start command given	
[76]	Digital input x30/2	
[77]	Digital input x30/3	
[78]	Digital input x30/4	
[80]	No Flow	
[81]	Dry Pump	
[82]	End of Curve	
[83]	Broken Belt	
[90]	ECB Drive Mode	
[91]	ECB Bypass Mode	
[92]	ECB Test Mode	
[93]	Emergency Mode	
[94]	RS Flipflop 0	
[95]	RS Flipflop 1	
[96]	RS Flipflop 2	
[97]	RS Flipflop 3	
[98]	RS Flipflop 4	
[99]	RS Flipflop 5	
[100]	RS Flipflop 6	See parameter 13-15 RS-FF Operand S, parameter 13-16 RS-FF Operand R.
[101]	RS Flipflop 7	
[102]	Verifying Flow	
[103]	Relay 1	
[104]	Relay 2	
[105]	Relay 3	
[106]	Relay 4	
[107]	Relay 5	
[108]	Relay 6	
[109]	Relay 7	
[110]	Relay 8	
[111]	Relay 9	
[112]	System On Ref	
[125]	Digital input x46/1	
[126]	Digital input x46/3	
[127]	Digital input x46/5	
[128]	Digital input x46/7	
[129]	Digital input x46/9	
[130]	Digital input x46/11	
[131]	Digital input x46/13	
[140]	ATEX ETR cur. warning	
[141]	ATEX ETR cur. alarm	
[142]	ATEX ETR freq. warning	

13-02 Stop Event	
Option:	Function:
[143] ATEX ETR freq. alarm	

3.12.2 13-1* Comparators

Comparators are used for comparing continuous variables (that is output frequency, output current, analog input, and so on) to fixed preset values.

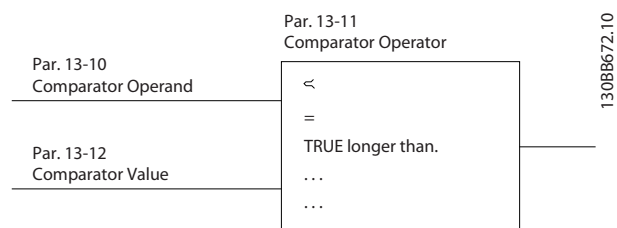

Figure 3.41 Comparators

There are digital values that are compared to fixed time values. See the explanation in *parameter 13-10 Comparator Operand*. Comparators are evaluated once in each scan interval. Use the result (true or false) directly. All parameters in this parameter group are array parameters with index 0–5. Select index 0 to program comparator 0, select index 1 to program comparator 1, and so on.

13-10 Comparator Operand	
Array [6]	
Option:	Function:
	Select the variable to be monitored by the comparator.
[0]	DISABLED
[1]	Reference %
[2]	Feedback %
[3]	Motor speed
[4]	Motor Current
[5]	Motor torque
[6]	Motor power
[7]	Motor voltage
[8]	DC-link voltage
[9]	Motor Thermal
[10]	Drive thermal
[11]	Heat sink temp.
[12]	Analog input AI53
[13]	Analog input AI54
[14]	Analog input AIFB10
[15]	Analog input AIS24V
[17]	Analog input AICCT
[18]	Pulse input FI29

13-10 Comparator Operand	
Array [6]	
Option:	Function:
[19]	Pulse input FI33
[20]	Alarm number
[21]	Warning number
[22]	Analog input x30 11
[23]	Analog input x30 12
[24]	Sensorless Flow
[25]	Sensorless Pressure
[26]	Flow Totalized Volume
[27]	Flow Actual Volume
[28]	Flow
[29]	Number Of Pump Running
[30]	Counter A
[31]	Counter B
[34]	Analog Input x48/2
[35]	Temp Input x48/4
[36]	Temp Input x48/7
[37]	Temp Input x48/10
[38]	Derag Counter
[40]	Analog input x42/1
[41]	Analog input x42/3
[42]	Analog input x42/5
[46]	AI53 scaled
[47]	AI54 scaled
[48]	AI53 unit
[49]	AI54 unit
[50]	FALSE
[51]	TRUE
[52]	Control ready
[53]	Drive ready
[54]	Running
[55]	Reversing
[56]	In range
[60]	On reference
[61]	Below reference, low
[62]	Above ref, high
[65]	Torque limit
[66]	Current Limit
[67]	Out of current range
[68]	Below I low
[69]	Above I high
[70]	Out of speed range
[71]	Below speed low
[72]	Above speed high
[75]	Out of feedback range
[76]	Below feedback low
[77]	Above feedback high
[80]	Thermal warning
[82]	Mains out of range

13-10 Comparator Operand		
Array [6]		
Option:	Function:	
[85]	Warning	
[86]	Alarm (trip)	
[87]	Alarm (trip lock)	
[90]	Bus OK	
[91]	Torque limit & stop	
[92]	Brake fault (IGBT)	
[94]	Safe stop active	
[100]	Comparator 0	
[101]	Comparator 1	
[102]	Comparator 2	
[103]	Comparator 3	
[104]	Comparator 4	
[105]	Comparator 5	
[110]	Logic rule 0	
[111]	Logic rule 1	
[112]	Logic rule 2	
[113]	Logic rule 3	
[114]	Logic rule 4	
[115]	Logic rule 5	
[120]	SL Time-out 0	
[121]	SL Time-out 1	
[122]	SL Time-out 2	
[123]	SL Time-out 3	
[124]	SL Time-out 4	
[125]	SL Time-out 5	
[126]	SL Time-out 6	
[127]	SL Time-out 7	
[130]	Digital input DI18	
[131]	Digital input DI19	
[132]	Digital input DI27	
[133]	Digital input DI29	
[134]	Digital input DI32	
[135]	Digital input DI33	
[150]	SL digital output A	
[151]	SL digital output B	
[152]	SL digital output C	
[153]	SL digital output D	
[154]	SL digital output E	
[155]	SL digital output F	
[160]	Relay 1	
[161]	Relay 2	
[162]	Relay 3	
[163]	Relay 4	
[164]	Relay 5	
[165]	Relay 6	
[166]	Relay 7	
[167]	Relay 8	
[168]	Relay 9	

13-10 Comparator Operand		
Array [6]		
Option:	Function:	
[180]	Local reference active	
[181]	Remote reference active	
[182]	Start command	
[183]	Drive stopped	
[185]	Drive in hand mode	
[186]	Drive in auto mode	
[187]	Start command given	
[190]	Digital input x30/2	
[191]	Digital input x30/3	
[192]	Digital input x30/4	
[193]	Digital input x46/1	
[194]	Digital input x46/3	
[195]	Digital input x46/5	
[196]	Digital input x46/7	
[197]	Digital input x46/9	
[198]	Digital input x46/11	
[199]	Digital input x46/13	
[204]	System On Ref	
[205]	No Flow	
[206]	Dry Pump	
[207]	End of Curve	
[208]	Broken Belt	
[209]	ECB Drive Mode	
[210]	ECB Bypass Mode	
[211]	ECB Test Mode	
[212]	Emergency Mode	
[240]	Totalized Vol in thousands	
[241]	Totalized Vol in millions	
[242]	Totalized Vol in billions	
[243]	Totalized Vol in trillions	
[245]	Actual Vol in thousands	
[246]	Actual Vol in millions	
[247]	Actual Vol in billions	
[248]	Actual Vol in trillions	
[249]	Therm. Sensor Temp.	

13-11 Comparator Operator		
Array [6]		
Option:	Function:	
[0]	<	Select [0] < for the result of the evaluation to be true, when the variable selected in <i>parameter 13-10 Comparator Operand</i> is smaller than the fixed value in <i>parameter 13-12 Comparator Value</i> . The result is false, if the variable selected in <i>parameter 13-10 Comparator Operand</i> is greater than the fixed value in <i>parameter 13-12 Comparator Value</i> .

13-11 Comparator Operator		
Array [6]		
Option:	Function:	
[1] ≈ (equal)	Select [1] ≈ for the result of the evaluation to be true, when the variable selected in <i>parameter 13-10 Comparator Operand</i> is approximately equal to the fixed value in <i>parameter 13-12 Comparator Value</i> .	
[2] >	Select [2] > for the inverse logic of option [0] <.	
[5] TRUE longer than..		
[6] FALSE longer than..		
[7] TRUE shorter than..		
[8] FALSE shorter than..		

13-12 Comparator Value		
Array [6]		
Range:	Function:	
Size related*	[-100000 - 100000]	Enter the trigger level for the variable that is monitored by this comparator. This is an array parameter containing comparator values 0–5.

3.12.3 RS Flip Flops

The reset/set flip flops hold the signal until set/reset.

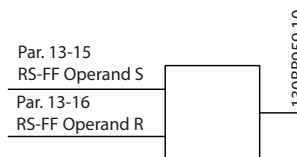

Figure 3.42 Reset/Set Flip Flops

2 parameters are used, and the output can be used in the logic rules and as events.

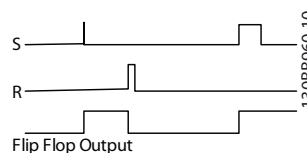

Figure 3.43 Flip Flop Outputs

The 2 operators can be selected from a long list. As a special case, the same digital input can be used as both set and reset, making it possible to use the same digital input as start/stop. The following settings can be used to set up the same digital input (for example, DI32) as start/stop.

Parameter	Setting	Notes
<i>Parameter 13-00 SL Controller Mode</i>	On	–
<i>Parameter 13-01 Start Event</i>	True	–
<i>Parameter 13-02 Stop Event</i>	False	–
<i>Parameter 13-40 Logic Rule Boolean 1 [0]</i>	[37] Digital Input DI32	–
<i>Parameter 13-42 Logic Rule Boolean 2 [0]</i>	[2] Running	–
<i>Parameter 13-41 Logic Rule Operator 1 [0]</i>	[3] AND NOT	–
<i>Parameter 13-40 Logic Rule Boolean 1 [1]</i>	[37] Digital Input DI32	–
<i>Parameter 13-42 Logic Rule Boolean 2 [1]</i>	[2] Running	–
<i>Parameter 13-41 Logic Rule Operator 1 [1]</i>	[1] AND	–

Parameter	Setting	Notes
Parameter 13-15 RS-FF Operand S [0]	[26] Logic rule 0	Output from parameter 13-41 Logic Rule Operator 1 [0].
Parameter 13-16 RS-FF Operand R [0]	[27] Logic rule 1	Output from parameter 13-41 Logic Rule Operator 1 [1].
Parameter 13-51 SL Controller Event [0]	[94] RS Flipflop 0	Output from parameter 13-15 RS-FF Operand S and parameter 13-16 RS-FF Operand R.
Parameter 13-52 SL Controller Action [0]	[22] Run	-
Parameter 13-51 SL Controller Event [1]	[27] Logic rule 1	-
Parameter 13-52 SL Controller Action [1]	[24] Stop	-

Table 3.21 Operators

13-15 RS-FF Operand S		
Array [8] Select the set input.		
Option:	Function:	
[0]	False	
[1]	True	
[2]	Running	
[3]	In range	
[4]	On reference	
[5]	Torque limit	
[6]	Current Limit	
[7]	Out of current range	
[8]	Below I low	
[9]	Above I high	
[10]	Out of speed range	
[11]	Below speed low	
[12]	Above speed high	
[13]	Out of feedb. range	
[14]	Below feedb. low	
[15]	Above feedb. high	
[16]	Thermal warning	
[17]	Mains out of range	
[18]	Reversing	
[19]	Warning	
[20]	Alarm (trip)	
[21]	Alarm (trip lock)	
[22]	Comparator 0	
[23]	Comparator 1	

13-15 RS-FF Operand S		
Array [8] Select the set input.		
Option:	Function:	
[24]	Comparator 2	
[25]	Comparator 3	
[26]	Logic rule 0	
[27]	Logic rule 1	
[28]	Logic rule 2	
[29]	Logic rule 3	
[30]	SL Time-out 0	
[31]	SL Time-out 1	
[32]	SL Time-out 2	
[33]	Digital input DI18	
[34]	Digital input DI19	
[35]	Digital input DI27	
[36]	Digital input DI29	
[37]	Digital input DI32	
[38]	Digital input DI33	
[39]	Start command	
[40]	Drive stopped	
[41]	Reset Trip	
[42]	Auto Reset Trip	
[43]	OK Key	
[44]	Reset Key	
[45]	Left Key	
[46]	Right Key	
[47]	Up Key	
[48]	Down Key	
[50]	Comparator 4	
[51]	Comparator 5	
[60]	Logic rule 4	
[61]	Logic rule 5	
[70]	SL Time-out 3	
[71]	SL Time-out 4	
[72]	SL Time-out 5	
[73]	SL Time-out 6	
[74]	SL Time-out 7	
[75]	Start command given	
[76]	Digital input x30/2	
[77]	Digital input x30/3	
[78]	Digital input x30/4	
[80]	No Flow	
[81]	Dry Pump	
[82]	End of Curve	
[83]	Broken Belt	
[90]	ECB Drive Mode	
[91]	ECB Bypass Mode	
[92]	ECB Test Mode	
[93]	Emergency Mode	
[94]	RS Flipflop 0	

13-15 RS-FF Operand S		
Array [8] Select the set input.		
Option:	Function:	
[95]	RS Flipflop 1	
[96]	RS Flipflop 2	
[97]	RS Flipflop 3	
[98]	RS Flipflop 4	
[99]	RS Flipflop 5	
[100]	RS Flipflop 6	
[101]	RS Flipflop 7	
[102]	Verifying Flow	
[103]	Relay 1	
[104]	Relay 2	
[105]	Relay 3	
[106]	Relay 4	
[107]	Relay 5	
[108]	Relay 6	
[109]	Relay 7	
[110]	Relay 8	
[111]	Relay 9	
[112]	System On Ref	
[125]	Digital input x46/1	
[126]	Digital input x46/3	
[127]	Digital input x46/5	
[128]	Digital input x46/7	
[129]	Digital input x46/9	
[130]	Digital input x46/11	
[131]	Digital input x46/13	
[140]	ATEX ETR cur. warning	
[141]	ATEX ETR cur. alarm	
[142]	ATEX ETR freq. warning	
[143]	ATEX ETR freq. alarm	

13-16 RS-FF Operand R		
Array [8] Select the reset input. The reset input takes priority over the set input.		
Option:	Function:	
[0]	False	
[1]	True	
[2]	Running	
[3]	In range	
[4]	On reference	
[5]	Torque limit	
[6]	Current Limit	
[7]	Out of current range	
[8]	Below I low	
[9]	Above I high	
[10]	Out of speed range	
[11]	Below speed low	
[12]	Above speed high	

13-16 RS-FF Operand R		
Array [8] Select the reset input. The reset input takes priority over the set input.		
Option:	Function:	
[13]	Out of feedb. range	
[14]	Below feedb. low	
[15]	Above feedb. high	
[16]	Thermal warning	
[17]	Mains out of range	
[18]	Reversing	
[19]	Warning	
[20]	Alarm (trip)	
[21]	Alarm (trip lock)	
[22]	Comparator 0	
[23]	Comparator 1	
[24]	Comparator 2	
[25]	Comparator 3	
[26]	Logic rule 0	
[27]	Logic rule 1	
[28]	Logic rule 2	
[29]	Logic rule 3	
[30]	SL Time-out 0	
[31]	SL Time-out 1	
[32]	SL Time-out 2	
[33]	Digital input DI18	
[34]	Digital input DI19	
[35]	Digital input DI27	
[36]	Digital input DI29	
[37]	Digital input DI32	
[38]	Digital input DI33	
[39]	Start command	
[40]	Drive stopped	
[41]	Reset Trip	
[42]	Auto Reset Trip	
[43]	OK Key	
[44]	Reset Key	
[45]	Left Key	
[46]	Right Key	
[47]	Up Key	
[48]	Down Key	
[50]	Comparator 4	
[51]	Comparator 5	
[60]	Logic rule 4	
[61]	Logic rule 5	
[70]	SL Time-out 3	
[71]	SL Time-out 4	
[72]	SL Time-out 5	
[73]	SL Time-out 6	
[74]	SL Time-out 7	
[75]	Start command given	

13-16 RS-FF Operand R		
Array [8]		
Select the reset input. The reset input takes priority over the set input.		
Option:	Function:	
[76]	Digital input x30/2	
[77]	Digital input x30/3	
[78]	Digital input x30/4	
[80]	No Flow	
[81]	Dry Pump	
[82]	End of Curve	
[83]	Broken Belt	
[90]	ECB Drive Mode	
[91]	ECB Bypass Mode	
[92]	ECB Test Mode	
[93]	Emergency Mode	
[94]	RS Flipflop 0	
[95]	RS Flipflop 1	
[96]	RS Flipflop 2	
[97]	RS Flipflop 3	
[98]	RS Flipflop 4	
[99]	RS Flipflop 5	
[100]	RS Flipflop 6	
[101]	RS Flipflop 7	
[102]	Verifying Flow	
[103]	Relay 1	
[104]	Relay 2	
[105]	Relay 3	
[106]	Relay 4	
[107]	Relay 5	
[108]	Relay 6	
[109]	Relay 7	
[110]	Relay 8	
[111]	Relay 9	
[112]	System On Ref	
[125]	Digital input x46/1	
[126]	Digital input x46/3	
[127]	Digital input x46/5	
[128]	Digital input x46/7	
[129]	Digital input x46/9	
[130]	Digital input x46/11	
[131]	Digital input x46/13	
[140]	ATEX ETR cur. warning	
[141]	ATEX ETR cur. alarm	
[142]	ATEX ETR freq. warning	
[143]	ATEX ETR freq. alarm	

3.12.4 13-2* Timers

Use the result (true or false) from timers directly to define an event (see *parameter 13-51 SL Controller Event*), or as boolean input in a logic rule (see *parameter 13-40 Logic Rule Boolean 1*, *parameter 13-42 Logic Rule Boolean 2*, or *parameter 13-44 Logic Rule Boolean 3*). A timer is only false when started by an action (for example [29] *Start timer 1*) until the timer value entered in this parameter has elapsed. Then it becomes true again.

All parameters in this parameter group are array parameters with index 0–2. Select index 0 to program timer 0, select index 1 to program timer 1, and so on.

13-20 SL Controller Timer		
Array [8]		
Range:	Function:	
Size related*	[0 - 0]	Enter the value to define the duration of the false output from the programmed timer. A timer is only false if it is started by an action (for example [29] <i>Start timer 1</i>) and until the given timer value has elapsed.

3.12.5 13-4* Logic Rules

Combine up to 3 boolean inputs (true/false inputs) from timers, comparators, digital inputs, status bits, and events using the logical operators AND, OR, and NOT. Select boolean inputs for the calculation in *parameter 13-40 Logic Rule Boolean 1*, *parameter 13-42 Logic Rule Boolean 2*, and *parameter 13-44 Logic Rule Boolean 3*. Define the operators used to logically combine the selected inputs in *parameter 13-41 Logic Rule Operator 1* and *parameter 13-43 Logic Rule Operator 2*.

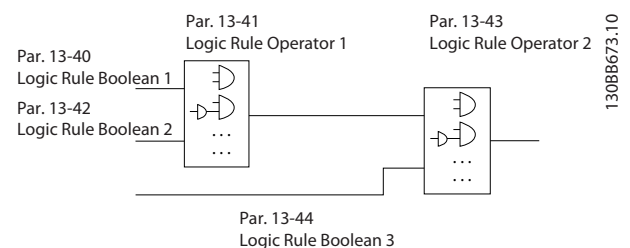

Figure 3.44 Logic Rules

Priority of calculation

The results of *parameter 13-40 Logic Rule Boolean 1*, *parameter 13-41 Logic Rule Operator 1*, and *parameter 13-42 Logic Rule Boolean 2* are calculated first. The outcome (true/false) of this calculation is combined with the settings of *parameter 13-43 Logic Rule Operator 2*

and parameter 13-44 Logic Rule Boolean 3, yielding the final result (true/false) of the logic rule.

13-40 Logic Rule Boolean 1		
Array [6]		
Option:	Function:	
[0]	False	Enters the fixed value of false in the logic rule.
[1]	True	Enters the fixed value of true in the logic rule.
[2]	Running	See <i>parameter group 5-3* Digital Outputs</i> for further description.
[3]	In range	See <i>parameter group 5-3* Digital Outputs</i> for further description.
[4]	On reference	See <i>parameter group 5-3* Digital Outputs</i> for further description.
[5]	Torque limit	See <i>parameter group 5-3* Digital Outputs</i> for further description.
[6]	Current Limit	See <i>parameter group 5-3* Digital Outputs</i> for further description.
[7]	Out of current range	See <i>parameter group 5-3* Digital Outputs</i> for further description.
[8]	Below I low	See <i>parameter group 5-3* Digital Outputs</i> for further description.
[9]	Above I high	See <i>parameter group 5-3* Digital Outputs</i> for further description.
[10]	Out of speed range	
[11]	Below speed low	See <i>parameter group 5-3* Digital Outputs</i> for further description.
[12]	Above speed high	See <i>parameter group 5-3* Digital Outputs</i> for further description.
[13]	Out of feedb. range	See <i>parameter group 5-3* Digital Outputs</i> for further description.
[14]	Below feedb. low	See <i>parameter group 5-3* Digital Outputs</i> for further description.
[15]	Above feedb. high	See <i>parameter group 5-3* Digital Outputs</i> for further description.
[16]	Thermal warning	See <i>parameter group 5-3* Digital Outputs</i> for further description.
[17]	Mains out of range	See <i>parameter group 5-3* Digital Outputs</i> for further description.
[18]	Reversing	See <i>parameter group 5-3* Digital Outputs</i> for further description.
[19]	Warning	See <i>parameter group 5-3* Digital Outputs</i> for further description.

13-40 Logic Rule Boolean 1		
Array [6]		
Option:	Function:	
[20]	Alarm (trip)	See <i>parameter group 5-3* Digital Outputs</i> for further description.
[21]	Alarm (trip lock)	See <i>parameter group 5-3* Digital Outputs</i> for further description.
[22]	Comparator 0	Use the result of comparator 0 in the logic rule.
[23]	Comparator 1	Use the result of comparator 1 in the logic rule.
[24]	Comparator 2	Use the result of comparator 2 in the logic rule.
[25]	Comparator 3	Use the result of comparator 3 in the logic rule.
[26]	Logic rule 0	Use the result of logic rule 0 in the logic rule.
[27]	Logic rule 1	Use the result of logic rule 1 in the logic rule.
[28]	Logic rule 2	Use the result of logic rule 2 in the logic rule.
[29]	Logic rule 3	Use the result of logic rule 3 in the logic rule.
[30]	SL Time-out 0	Use the result of timer 0 in the logic rule.
[31]	SL Time-out 1	Use the result of timer 1 in the logic rule.
[32]	SL Time-out 2	Use the result of timer 2 in the logic rule.
[33]	Digital input DI18	Use the value of DI18 in the logic rule (High = true).
[34]	Digital input DI19	Use the value of DI19 in the logic rule (High = true).
[35]	Digital input DI27	Use the value of DI27 in the logic rule (High = true).
[36]	Digital input DI29	Use the value of DI29 in the logic rule (High = true).
[37]	Digital input DI32	Use the value of DI32 in the logic rule (High = true).
[38]	Digital input DI33	Use the value of DI33 in the logic rule (High = true).
[39]	Start command	This logic rule is true if the frequency converter is started either via digital input, fieldbus, or other.

13-40 Logic Rule Boolean 1		
Array [6]		
Option:	Function:	
[40]	Drive stopped	This logic rule is true if the frequency converter is stopped or coasted either via digital input, fieldbus, or other.
[41]	Reset Trip	This logic rule is true if the frequency converter is tripped (but not trip-locked) and [Reset] is pressed.
[42]	Auto Reset Trip	This logic rule is true if the frequency converter is tripped (but not trip-locked) and an automatic reset is issued.
[43]	OK Key	This logic rule is true if [OK] is pressed.
[44]	Reset Key	This logic rule is true if [Reset] is pressed.
[45]	Left Key	This logic rule is true if [◀] is pressed.
[46]	Right Key	This logic rule is true if [▶] is pressed.
[47]	Up Key	This logic rule is true if [▲] is pressed.
[48]	Down Key	This logic rule is true if [▼] is pressed.
[50]	Comparator 4	Use the result of comparator 4 in the logic rule.
[51]	Comparator 5	Use the result of comparator 5 in the logic rule.
[60]	Logic rule 4	Use the result of logic rule 4 in the logic rule.
[61]	Logic rule 5	Use the result of logic rule 5 in the logic rule.
[70]	SL Time-out 3	Use the result of timer 3 in the logic rule.
[71]	SL Time-out 4	Use the result of timer 4 in the logic rule.
[72]	SL Time-out 5	Use the result of timer 5 in the logic rule.
[73]	SL Time-out 6	Use the result of timer 6 in the logic rule.
[74]	SL Time-out 7	Use the result of timer 7 in the logic rule.
[75]	Start command given	
[76]	Digital input x30/2	
[77]	Digital input x30/3	
[78]	Digital input x30/4	
[80]	No Flow	
[81]	Dry Pump	
[82]	End of Curve	

13-40 Logic Rule Boolean 1		
Array [6]		
Option:	Function:	
[83]	Broken Belt	
[90]	ECB Drive Mode	
[91]	ECB Bypass Mode	
[92]	ECB Test Mode	
[93]	Emergency Mode	
[94]	RS Flipflop 0	
[95]	RS Flipflop 1	
[96]	RS Flipflop 2	
[97]	RS Flipflop 3	
[98]	RS Flipflop 4	
[99]	RS Flipflop 5	
[100]	RS Flipflop 6	See <i>parameter 13-15 RS-FF Operand S</i> , <i>parameter 13-16 RS-FF Operand R</i> .
[101]	RS Flipflop 7	
[102]	Verifying Flow	
[103]	Relay 1	
[104]	Relay 2	
[105]	Relay 3	
[106]	Relay 4	
[107]	Relay 5	
[108]	Relay 6	
[109]	Relay 7	
[110]	Relay 8	
[111]	Relay 9	
[112]	System On Ref	
[125]	Digital input x46/1	
[126]	Digital input x46/3	
[127]	Digital input x46/5	
[128]	Digital input x46/7	
[129]	Digital input x46/9	
[130]	Digital input x46/11	
[131]	Digital input x46/13	
[140]	ATEX ETR cur. warning	
[141]	ATEX ETR cur. alarm	
[142]	ATEX ETR freq. warning	
[143]	ATEX ETR freq. alarm	

13-41 Logic Rule Operator 1		
Array [6]		
Option:	Function:	
		Select the 1 st logical operator to use on the boolean inputs from <i>parameter 13-40 Logic Rule</i>

13-41 Logic Rule Operator 1		
Array [6]		
Option:	Function:	
		Boolean 1 and parameter 13-42 Logic Rule Boolean 2. Parameter numbers in square brackets stand for the boolean inputs of parameters in parameter group 13-** Smart Logic Control.
[0]	DISABLED	Ignores: <ul style="list-style-type: none"> Parameter 13-42 Logic Rule Boolean 2. Parameter 13-43 Logic Rule Operator 2. Parameter 13-44 Logic Rule Boolean 3.
[1]	AND	Evaluates the expression [13-40] AND [13-42].
[2]	OR	Evaluates the expression [13-40] OR [13-42].
[3]	AND NOT	Evaluates the expression [13-40] AND NOT [13-42].
[4]	OR NOT	Evaluates the expression [13-40] OR NOT [13-42].
[5]	NOT AND	Evaluates the expression NOT [13-40] AND [13-42].
[6]	NOT OR	Evaluates the expression NOT [13-40] OR [13-42].
[7]	NOT AND NOT	Evaluates the expression NOT [13-40] AND NOT [13-42].
[8]	NOT OR NOT	Evaluates the expression NOT [13-40] OR NOT [13-42].

13-42 Logic Rule Boolean 2		
Array [6]		
Option:	Function:	
		Select the 2 nd boolean (true or false) input for the selected logic rule. See parameter 13-40 Logic Rule Boolean 1 for further descriptions of options and their functions.
[0]	False	
[1]	True	
[2]	Running	
[3]	In range	
[4]	On reference	
[5]	Torque limit	
[6]	Current Limit	
[7]	Out of current range	
[8]	Below I low	
[9]	Above I high	
[10]	Out of speed range	
[11]	Below speed low	

13-42 Logic Rule Boolean 2		
Array [6]		
Option:	Function:	
[12]	Above speed high	
[13]	Out of feedb. range	
[14]	Below feedb. low	
[15]	Above feedb. high	
[16]	Thermal warning	
[17]	Mains out of range	
[18]	Reversing	
[19]	Warning	
[20]	Alarm (trip)	
[21]	Alarm (trip lock)	
[22]	Comparator 0	
[23]	Comparator 1	
[24]	Comparator 2	
[25]	Comparator 3	
[26]	Logic rule 0	
[27]	Logic rule 1	
[28]	Logic rule 2	
[29]	Logic rule 3	
[30]	SL Time-out 0	
[31]	SL Time-out 1	
[32]	SL Time-out 2	
[33]	Digital input DI18	
[34]	Digital input DI19	
[35]	Digital input DI27	
[36]	Digital input DI29	
[37]	Digital input DI32	
[38]	Digital input DI33	
[39]	Start command	
[40]	Drive stopped	
[41]	Reset Trip	
[42]	Auto Reset Trip	
[43]	OK Key	
[44]	Reset Key	
[45]	Left Key	
[46]	Right Key	
[47]	Up Key	
[48]	Down Key	
[50]	Comparator 4	
[51]	Comparator 5	
[60]	Logic rule 4	
[61]	Logic rule 5	
[70]	SL Time-out 3	
[71]	SL Time-out 4	
[72]	SL Time-out 5	
[73]	SL Time-out 6	
[74]	SL Time-out 7	
[75]	Start command given	
[76]	Digital input x30/2	

13-42 Logic Rule Boolean 2		
Array [6]		
Option:	Function:	
[77]	Digital input x30/3	
[78]	Digital input x30/4	
[80]	No Flow	
[81]	Dry Pump	
[82]	End of Curve	
[83]	Broken Belt	
[90]	ECB Drive Mode	
[91]	ECB Bypass Mode	
[92]	ECB Test Mode	
[93]	Emergency Mode	
[94]	RS Flipflop 0	See parameter 13-15 RS-FF Operand S, parameter 13-16 RS-FF Operand R.
[95]	RS Flipflop 1	See parameter 13-15 RS-FF Operand S, parameter 13-16 RS-FF Operand R.
[96]	RS Flipflop 2	See parameter 13-15 RS-FF Operand S, parameter 13-16 RS-FF Operand R.
[97]	RS Flipflop 3	See parameter 13-15 RS-FF Operand S, parameter 13-16 RS-FF Operand R.
[98]	RS Flipflop 4	See parameter 13-15 RS-FF Operand S, parameter 13-16 RS-FF Operand R.
[99]	RS Flipflop 5	See parameter 13-15 RS-FF Operand S, parameter 13-16 RS-FF Operand R.
[100]	RS Flipflop 6	See parameter 13-15 RS-FF Operand S, parameter 13-16 RS-FF Operand R.
[101]	RS Flipflop 7	See parameter 13-15 RS-FF Operand S, parameter 13-16 RS-FF Operand R.
[102]	Verifying Flow	
[103]	Relay 1	
[104]	Relay 2	
[105]	Relay 3	
[106]	Relay 4	
[107]	Relay 5	
[108]	Relay 6	
[109]	Relay 7	
[110]	Relay 8	
[111]	Relay 9	
[112]	System On Ref	
[125]	Digital input x46/1	
[126]	Digital input x46/3	
[127]	Digital input x46/5	
[128]	Digital input x46/7	
[129]	Digital input x46/9	
[130]	Digital input x46/11	
[131]	Digital input x46/13	
[140]	ATEX ETR cur. warning	

13-42 Logic Rule Boolean 2		
Array [6]		
Option:	Function:	
[141]	ATEX ETR cur. alarm	
[142]	ATEX ETR freq. warning	
[143]	ATEX ETR freq. alarm	

13-43 Logic Rule Operator 2		
Array [6]		
Option:	Function:	
		Select the 2 nd logical operator to be used on the boolean input calculated in: <ul style="list-style-type: none"> Parameter 13-40 Logic Rule Boolean 1. Parameter 13-41 Logic Rule Operator 1. Parameter 13-42 Logic Rule Boolean 2. [13-44] signifies the boolean input of parameter 13-44 Logic Rule Boolean 3. [13-40/13-42] signifies the boolean input calculated in: <ul style="list-style-type: none"> Parameter 13-40 Logic Rule Boolean 1. Parameter 13-41 Logic Rule Operator 1. Parameter 13-42 Logic Rule Boolean 2.
[0]	DISABLED	Select this option to ignore parameter 13-44 Logic Rule Boolean 3.
[1]	AND	
[2]	OR	
[3]	AND NOT	
[4]	OR NOT	
[5]	NOT AND	
[6]	NOT OR	
[7]	NOT AND NOT	
[8]	NOT OR NOT	

13-44 Logic Rule Boolean 3		
Array [6]		
Option:	Function:	
		Select the 3 rd boolean (true or false) input for the selected logic rule. See parameter 13-40 Logic Rule Boolean 1 for further descriptions of options and their functions.
[0]	False	
[1]	True	
[2]	Running	
[3]	In range	

13-44 Logic Rule Boolean 3		
Array [6]		
Option:	Function:	
[4]	On reference	
[5]	Torque limit	
[6]	Current Limit	
[7]	Out of current range	
[8]	Below I low	
[9]	Above I high	
[10]	Out of speed range	
[11]	Below speed low	
[12]	Above speed high	
[13]	Out of feedb. range	
[14]	Below feedb. low	
[15]	Above feedb. high	
[16]	Thermal warning	
[17]	Mains out of range	
[18]	Reversing	
[19]	Warning	
[20]	Alarm (trip)	
[21]	Alarm (trip lock)	
[22]	Comparator 0	
[23]	Comparator 1	
[24]	Comparator 2	
[25]	Comparator 3	
[26]	Logic rule 0	
[27]	Logic rule 1	
[28]	Logic rule 2	
[29]	Logic rule 3	
[30]	SL Time-out 0	
[31]	SL Time-out 1	
[32]	SL Time-out 2	
[33]	Digital input DI18	
[34]	Digital input DI19	
[35]	Digital input DI27	
[36]	Digital input DI29	
[37]	Digital input DI32	
[38]	Digital input DI33	
[39]	Start command	
[40]	Drive stopped	
[41]	Reset Trip	
[42]	Auto Reset Trip	
[43]	OK Key	
[44]	Reset Key	
[45]	Left Key	
[46]	Right Key	
[47]	Up Key	
[48]	Down Key	
[50]	Comparator 4	
[51]	Comparator 5	
[60]	Logic rule 4	
[61]	Logic rule 5	

13-44 Logic Rule Boolean 3		
Array [6]		
Option:	Function:	
[70]	SL Time-out 3	
[71]	SL Time-out 4	
[72]	SL Time-out 5	
[73]	SL Time-out 6	
[74]	SL Time-out 7	
[75]	Start command given	
[76]	Digital input x30/2	
[77]	Digital input x30/3	
[78]	Digital input x30/4	
[80]	No Flow	
[81]	Dry Pump	
[82]	End of Curve	
[83]	Broken Belt	
[90]	ECB Drive Mode	
[91]	ECB Bypass Mode	
[92]	ECB Test Mode	
[93]	Emergency Mode	
[94]	RS Flipflop 0	
[95]	RS Flipflop 1	
[96]	RS Flipflop 2	
[97]	RS Flipflop 3	
[98]	RS Flipflop 4	
[99]	RS Flipflop 5	
[100]	RS Flipflop 6	See parameter 13-15 RS-FF Operand S, parameter 13-16 RS-FF Operand R.
[101]	RS Flipflop 7	
[102]	Verifying Flow	
[103]	Relay 1	
[104]	Relay 2	
[105]	Relay 3	
[106]	Relay 4	
[107]	Relay 5	
[108]	Relay 6	
[109]	Relay 7	
[110]	Relay 8	
[111]	Relay 9	
[112]	System On Ref	
[125]	Digital input x46/1	
[126]	Digital input x46/3	
[127]	Digital input x46/5	
[128]	Digital input x46/7	
[129]	Digital input x46/9	
[130]	Digital input x46/11	
[131]	Digital input x46/13	
[140]	ATEX ETR cur. warning	
[141]	ATEX ETR cur. alarm	
[142]	ATEX ETR freq. warning	

13-44 Logic Rule Boolean 3		
Array [6]		
Option:	Function:	
[143]	ATEX ETR freq. alarm	

3.12.6 13-5* States

13-51 SL Controller Event		
Array [20]		
Option:	Function:	
		Select the boolean input (true or false) to define the smart logic controller event. See <i>parameter 13-02 Stop Event</i> for further descriptions of options and their functions.
[0]	False	
[1]	True	
[2]	Running	
[3]	In range	
[4]	On reference	
[5]	Torque limit	
[6]	Current Limit	
[7]	Out of current range	
[8]	Below I low	
[9]	Above I high	
[10]	Out of speed range	
[11]	Below speed low	
[12]	Above speed high	
[13]	Out of feedb. range	
[14]	Below feedb. low	
[15]	Above feedb. high	
[16]	Thermal warning	
[17]	Mains out of range	
[18]	Reversing	
[19]	Warning	
[20]	Alarm (trip)	
[21]	Alarm (trip lock)	
[22]	Comparator 0	
[23]	Comparator 1	
[24]	Comparator 2	
[25]	Comparator 3	
[26]	Logic rule 0	
[27]	Logic rule 1	
[28]	Logic rule 2	
[29]	Logic rule 3	
[30]	SL Time-out 0	
[31]	SL Time-out 1	
[32]	SL Time-out 2	
[33]	Digital input DI18	

13-51 SL Controller Event		
Array [20]		
Option:	Function:	
[34]	Digital input DI19	
[35]	Digital input DI27	
[36]	Digital input DI29	
[37]	Digital input DI32	
[38]	Digital input DI33	
[39]	Start command	
[40]	Drive stopped	
[41]	Reset Trip	
[42]	Auto Reset Trip	
[43]	OK Key	
[44]	Reset Key	
[45]	Left Key	
[46]	Right Key	
[47]	Up Key	
[48]	Down Key	
[50]	Comparator 4	
[51]	Comparator 5	
[60]	Logic rule 4	
[61]	Logic rule 5	
[70]	SL Time-out 3	
[71]	SL Time-out 4	
[72]	SL Time-out 5	
[73]	SL Time-out 6	
[74]	SL Time-out 7	
[75]	Start command given	
[76]	Digital input x30/2	
[77]	Digital input x30/3	
[78]	Digital input x30/4	
[80]	No Flow	
[81]	Dry Pump	
[82]	End of Curve	
[83]	Broken Belt	
[90]	ECB Drive Mode	
[91]	ECB Bypass Mode	
[92]	ECB Test Mode	
[93]	Emergency Mode	
[94]	RS Flipflop 0	See <i>parameter 13-15 RS-FF Operand S</i> , <i>parameter 13-16 RS-FF Operand R</i> .
[95]	RS Flipflop 1	See <i>parameter 13-15 RS-FF Operand S</i> , <i>parameter 13-16 RS-FF Operand R</i> .
[96]	RS Flipflop 2	See <i>parameter 13-15 RS-FF Operand S</i> , <i>parameter 13-16 RS-FF Operand R</i> .
[97]	RS Flipflop 3	See <i>parameter 13-15 RS-FF Operand S</i> , <i>parameter 13-16 RS-FF Operand R</i> .
[98]	RS Flipflop 4	See <i>parameter 13-15 RS-FF Operand S</i> , <i>parameter 13-16 RS-FF Operand R</i> .

13-51 SL Controller Event		
Array [20]		
Option:	Function:	
[99]	RS Flipflop 5	See <i>parameter 13-15 RS-FF Operand S</i> , <i>parameter 13-16 RS-FF Operand R</i> .
[100]	RS Flipflop 6	See <i>parameter 13-15 RS-FF Operand S</i> , <i>parameter 13-16 RS-FF Operand R</i> .
[101]	RS Flipflop 7	See <i>parameter 13-15 RS-FF Operand S</i> , <i>parameter 13-16 RS-FF Operand R</i> .
[102]	Verifying Flow	
[103]	Relay 1	
[104]	Relay 2	
[105]	Relay 3	
[106]	Relay 4	
[107]	Relay 5	
[108]	Relay 6	
[109]	Relay 7	
[110]	Relay 8	
[111]	Relay 9	
[112]	System On Ref	
[125]	Digital input x46/1	
[126]	Digital input x46/3	
[127]	Digital input x46/5	
[128]	Digital input x46/7	
[129]	Digital input x46/9	
[130]	Digital input x46/11	
[131]	Digital input x46/13	
[140]	ATEX ETR cur. warning	
[141]	ATEX ETR cur. alarm	
[142]	ATEX ETR freq. warning	
[143]	ATEX ETR freq. alarm	

13-52 SL Controller Action		
Array [20]		
Option:	Function:	
		Select the action corresponding to the SLC event. Actions are executed when the corresponding event (defined in <i>parameter 13-51 SL Controller Event</i>) is evaluated as true. The following actions are available for selection:
[0]	Disabled	
[1]	No action	
[2]	Select set-up 1	Changes the active set-up (<i>parameter 0-10 Active Set-up</i>) to 1.
[3]	Select set-up 2	Changes the active set-up (<i>parameter 0-10 Active Set-up</i>) to 2.

13-52 SL Controller Action		
Array [20]		
Option:	Function:	
[4]	Select set-up 3	Changes the active set-up (<i>parameter 0-10 Active Set-up</i>) to 3.
[5]	Select set-up 4	Changes the active set-up (<i>parameter 0-10 Active Set-up</i>) to 4. If the set-up is changed, it merges with other set-up commands coming from either the digital inputs or via a fieldbus.
[10]	Select preset ref 0	Selects preset reference 0.
[11]	Select preset ref 1	Selects preset reference 1.
[12]	Select preset ref 2	Selects preset reference 2.
[13]	Select preset ref 3	Selects preset reference 3.
[14]	Select preset ref 4	Selects preset reference 4.
[15]	Select preset ref 5	Selects preset reference 5.
[16]	Select preset ref 6	Selects preset reference 6.
[17]	Select preset ref 7	Selects preset reference 7. If the active preset reference is changed, it merges with other preset reference commands coming from either the digital inputs or via a fieldbus.
[18]	Select ramp 1	Selects ramp 1.
[19]	Select ramp 2	Selects ramp 2.
[22]	Run	Issues a start command to the frequency converter.
[23]	Run reverse	Issues a start reverse command to the frequency converter.
[24]	Stop	Issues a stop command to the frequency converter.
[26]	DC Brake	Issues a DC stop command to the frequency converter.
[27]	Coast	The frequency converter coasts immediately. All stop commands including the coast command stop the SLC.
[28]	Freeze output	Freezes the output frequency of the frequency converter.
[29]	Start timer 0	Starts timer 0, see <i>parameter 13-20 SL Controller Timer</i> for further description.
[30]	Start timer 1	Starts timer 1, see <i>parameter 13-20 SL Controller Timer</i> for further description.

13-52 SL Controller Action		
Array [20]		
Option:	Function:	
[31]	Start timer 2	Starts timer 2, see <i>parameter 13-20 SL Controller Timer</i> for further description.
[32]	Set digital out A low	Any output with digital output 1 selected is low (off).
[33]	Set digital out B low	Any output with digital output 2 selected is low (off).
[34]	Set digital out C low	Any output with digital output 3 selected is low (off).
[35]	Set digital out D low	Any output with digital output 4 selected is low (off).
[36]	Set digital out E low	Any output with digital output 5 selected is low (off).
[37]	Set digital out F low	Any output with digital output 6 selected is low (off).
[38]	Set digital out A high	Any output with digital output 1 selected is high (closed).
[39]	Set digital out B high	Any output with digital output 2 selected is high (closed).
[40]	Set digital out C high	Any output with digital output 3 selected is high (closed).
[41]	Set digital out D high	Any output with digital output 4 selected is high (closed).
[42]	Set digital out E high	Any output with digital output 5 selected is high (closed).
[43]	Set digital out F high	Any output with digital output 6 selected is high (closed).
[60]	Reset Counter A	Resets counter A to 0.
[61]	Reset Counter B	Resets counter B to 0.
[62]	Counter A (up)	
[63]	Counter A (down)	
[64]	Counter B (up)	
[65]	Counter B (down)	
[70]	Start Timer 3	Starts timer 3, see <i>parameter 13-20 SL Controller Timer</i> for further description.
[71]	Start Timer 4	Starts timer 4, see <i>parameter 13-20 SL Controller Timer</i> for further description.
[72]	Start Timer 5	Starts timer 5, see <i>parameter 13-20 SL Controller Timer</i> for further description.
[73]	Start Timer 6	Starts timer 6, see <i>parameter 13-20 SL Controller Timer</i> for further description.

13-52 SL Controller Action		
Array [20]		
Option:	Function:	
[74]	Start Timer 7	Starts timer 7, see <i>parameter 13-20 SL Controller Timer</i> for further description.
[80]	Sleep Mode	Starts the sleep mode.
[81]	Derag	Starts deragging (see <i>parameter group 29-0* Pipe Fill</i> for further information).
[82]	Reset Derag Counter	
[90]	Set ECB Bypass Mode	
[91]	Set ECB Drive Mode	
[100]	Reset Alarms	
[101]	Reset Flow Totalized Volume Counter	
[102]	Reset Flow Actual Volume Counter	

3.12.7 13-9* User-defined Alerts and Readouts

Parameters in this group allow the configuration of application-specific messages, warnings, and alarms. Use the following parameters to configure the frequency converter to show a message and perform an action when a specific event occurs:

- *Parameter 13-90 Alert Trigger* – the event that triggers the user-defined action and message.
- *Parameter 13-91 Alert Action* – the action that the frequency converter performs when the event defined in *parameter 13-90 Alert Trigger* occurs.
- *Parameter 13-92 Alert Text* – the text that the frequency converter shows in the display when the event defined in *parameter 13-90 Alert Trigger* occurs.

For example, consider the following use case: If there is an active signal on digital input 32, the frequency converter shows the message *Valve 5 open* and ramps down to a stop.

To achieve this configuration, make the following settings:

- *Parameter 13-90 Alert Trigger* = [37] Digital input DI32.
- *Parameter 13-91 Alert Action* = [5] Stop & warning.
- *Parameter 13-92 Alert Text* = Valve 5 open.

13-90 Alert Trigger		
Array [10]		
Select the event that triggers the user-defined action and message.		
Option:	Function:	
[0] *	False	
[1]	True	
[18]	Reversing	
[22]	Comparator 0	
[23]	Comparator 1	
[24]	Comparator 2	
[25]	Comparator 3	
[26]	Logic rule 0	
[27]	Logic rule 1	
[28]	Logic rule 2	
[29]	Logic rule 3	
[30]	SL Time-out 0	
[31]	SL Time-out 1	
[32]	SL Time-out 2	
[33]	Digital input DI18	
[34]	Digital input DI19	
[35]	Digital input DI27	
[36]	Digital input DI29	
[37]	Digital input DI32	
[38]	Digital input DI33	

13-90 Alert Trigger		
Array [10]		
Select the event that triggers the user-defined action and message.		
Option:	Function:	
[50]	Comparator 4	
[51]	Comparator 5	
[60]	Logic rule 4	
[61]	Logic rule 5	
[70]	SL Time-out 3	
[71]	SL Time-out 4	
[72]	SL Time-out 5	
[73]	SL Time-out 6	
[74]	SL Time-out 7	
[90]	ECB Drive Mode	
[91]	ECB Bypass Mode	

13-91 Alert Action		
Array [10]		
Select the action that the frequency converter performs when the event defined in <i>parameter 13-90 Alert Trigger</i> occurs.		
Option:	Function:	
[0] *	Info	
[1]	Warning	
[2]	Freeze output	
[3]	Freeze output & warn	
[4]	Stop	
[5]	Stop & warning	
[6]	Jogging	
[7]	Jogging & warning	
[8]	Max speed	
[9]	Max speed & warn	
[10]	Stop and trip	
[11]	Stop and trip w manual reset	
[12]	Trip	
[13]	Trip w manual reset	
[14]	Trip Lock	

13-92 Alert Text		
Range:	Function:	
Size related*	[0 - 20]	Array [10] Enter the text that the frequency converter shows in the display when the event defined in <i>parameter 13-90 Alert Trigger</i> occurs.

13-97 Alert Alarm Word		
Range:	Function:	
0*	[0 - 4294967295]	Shows the alarm word of a user-defined alarm in hex code.

3

13-98 Alert Warning Word		
Range:		Function:
0*	[0 - 4294967295]	Shows the warning word of a user-defined alarm in hex code.

13-99 Alert Status Word		
Range:		Function:
0*	[0 - 4294967295]	Shows the status word of a user-defined alarm in hex code.

3.13 Parameters 14-** Special Functions

3.13.1 14-0* Inverter Switching

14-00 Switching Pattern		
Option:	Function:	
		Select the switching pattern: 60° AVM or SFAVM.
[0]	60 AVM	
[1]	SFAVM	

14-01 Switching Frequency		
Option:	Function:	
		Select the inverter switching frequency. Changing the switching frequency can help reduce acoustic noise from the motor. NOTICE! The output frequency value of the frequency converter must never exceed 1/10 of the switching frequency. When the motor is running, adjust the switching frequency in <i>parameter 14-01 Switching Frequency</i> until the motor is as noiseless as possible. See also <i>parameter 14-00 Switching Pattern</i> . For information about derating, see the relevant <i>design guide</i> .
[0]	1.0 kHz	
[1]	1.5 kHz	
[2]	2.0 kHz	
[3]	2.5 kHz	
[4]	3.0 kHz	
[5]	3.5 kHz	
[6]	4.0 kHz	
[7]	5.0 kHz	
[8]	6.0 kHz	
[9]	7.0 kHz	
[10]	8.0 kHz	
[11]	10.0 kHz	
[12]	12.0kHz	
[13]	14.0 kHz	
[14]	16.0kHz	

14-03 Overmodulation		
Option:	Function:	
[0]	Off	Selects no overmodulation of the output voltage to avoid torque ripple on the motor shaft.
[1] *	On	The overmodulation function generates an extra voltage of up to 8% of U_{max} output voltage without overmodulation. This extra voltage results in an extra torque of 10–12% in the middle of the oversyn-

14-03 Overmodulation		
Option:	Function:	
		chronous range (from 0% at nominal speed, rising to approximately 12% at double nominal speed).

14-04 Acoustic Noise Reduction		
Option:	Function:	
[0] *	Off	No change of the acoustic motor switching noise.
[1]	On	Select to reduce the acoustic noise from the motor.

3.13.2 14-1* Mains On/Off

Parameters for configuring mains failure monitoring and handling.

14-10 Mains Failure		
Option:	Function:	
		Select the function by which the frequency converter must act when the threshold set in <i>parameter 14-11 Mains Fault Voltage Level</i> has been reached or a <i>Mains Failure Inverse</i> command is activated via 1 of the digital inputs (<i>parameter group 5-1* Digital Inputs</i>). Only selections [0] No function, [3] Coasting, or [6] Alarm are available when <i>parameter 1-10 Motor Construction</i> is set to [1] PM, non-salient SPM.
[0]	No function	The energy left in the capacitor bank is used to run the motor, but is discharged.
[1]	Ctrl. ramp-down	The frequency converter performs a controlled ramp down. <i>Parameter 2-10 Brake Function</i> must be set to [0] Off.
[3]	Coasting	The frequency converter turns off and the capacitor bank backs up the control card, thus ensuring a faster restart when mains reconnect (at short power zags).
[4]	Kinetic back-up	Kinetic back-up ensures that the frequency converter keeps running as long as there is energy in the system due to the inertia from motor and load. This is done by converting the mechanical energy to the DC link and maintaining control of the frequency converter and motor. This can extend the controlled operation, depending on the inertia in the system. For fans, it is typically several seconds; for pumps up to 2 s; and for compressors only for a fraction of a second. Many industry applications can extend controlled operation for many seconds, which is often enough time for the mains to return.

14-10 Mains Failure											
Option:	Function:										
	<table border="1"> <tr><td>A</td><td>Normal operation</td></tr> <tr><td>B</td><td>Mains failure</td></tr> <tr><td>C</td><td>Kinetic back-up</td></tr> <tr><td>D</td><td>Mains return</td></tr> <tr><td>E</td><td>Normal operation: ramping</td></tr> </table> <p>Figure 3.45 Kinetic Back-up</p> <p>The DC level during [4] Kinetic back-up equals parameter 14-11 Mains Fault Voltage Level x 1.35. If the mains does not return, U_{DC} is maintained as long as possible by ramping the speed down towards 0 RPM. Finally, the frequency converter coasts.</p> <p>If the mains return while in kinetic back-up mode, U_{DC} increases above parameter 14-11 Mains Fault Voltage Level x 1.35. This is detected in 1 of the following ways:</p> <ul style="list-style-type: none"> If $U_{DC} > \text{parameter 14-11 Mains Fault Voltage Level} \times 1.35 \times 1.05$. If the speed is above the reference. This is relevant if the mains come back at a lower level than before, for example parameter 14-11 Mains Fault Voltage Level x 1.35 x 1.02. This does not fulfill the criterion in point 1, and the frequency converter tries to reduce U_{DC} to parameter 14-11 Mains Fault Voltage Level x 1.35 by increasing the speed. This cannot be done as the mains cannot be lowered. If running mechanically. The same mechanism as in point 2 applies, but the inertia prevents the speed from going above the reference speed. This leads to the motor running mechanically until the speed is above the reference speed and the situation in point 2 occurs. Instead of waiting for that criterion, point 3 is introduced. 	A	Normal operation	B	Mains failure	C	Kinetic back-up	D	Mains return	E	Normal operation: ramping
A	Normal operation										
B	Mains failure										
C	Kinetic back-up										
D	Mains return										
E	Normal operation: ramping										

14-10 Mains Failure									
Option:	Function:								
[5]	<p>Kinetic back-up, trip</p> <p>The difference between kinetic back-up with and without trip is that the latter always ramps down to 0 RPM and trips, regardless of whether mains returns or not.</p> <p>The function does not detect if mains return. This is the reason for the relatively high level on the DC link during ramp down.</p> <table border="1"> <tr><td>A</td><td>Normal operation</td></tr> <tr><td>B</td><td>Mains failure</td></tr> <tr><td>C</td><td>Kinetic back-up</td></tr> <tr><td>D</td><td>Trip</td></tr> </table> <p>Figure 3.46 Kinetic Back-up Trip</p>	A	Normal operation	B	Mains failure	C	Kinetic back-up	D	Trip
A	Normal operation								
B	Mains failure								
C	Kinetic back-up								
D	Trip								
[6]	Alarm								
[7]	<p>Kin. back-up, trip w recovery</p> <p>This option is valid in VVC⁺ only. Kinetic back-up with recovery combines the features of kinetic back-up and kinetic back-up with trip. This feature makes it possible to select between kinetic back-up and kinetic back-up with trip, based on a recovery speed, configurable in parameter 14-15 Kin. Back-up Trip Recovery Level. If mains do not return, the frequency converter ramps down to 0 RPM and trips. If mains return while in kinetic back-up at a speed above the value in parameter 14-15 Kin. Back-up Trip Recovery Level, normal operation is resumed. This is equal to [4] Kinetic Back-up. The DC level during [7] Kinetic back-up is parameter 14-11 Mains Fault Voltage Level x 1.35.</p>								

14-10 Mains Failure

Option: **Function:**

A	Normal operation.
B	Mains failure.
C	Kinetic back-up.
D	Mains return.
E	Normal operation: ramping.

Figure 3.47 Kinetic Back-Up, Trip with Recovery where Mains Return above
Parameter 14-15 Kin. Back-up Trip Recovery Level

If mains return while in kinetic back-up at a speed below *parameter 14-15 Kin. Back-up Trip Recovery Level*, the frequency converter ramps down to 0 RPM using the ramp and then trips. If the ramp is slower than the system ramping down on its own, the ramping is done mechanically and U_{DC} is at the normal level ($U_{DC, m} \times 1.35$).

A	Normal operation.
B	Mains failure.
C	Kinetic back-up.
D	Mains return.
E	Kinetic back-up, ramping to trip.
F	Trip.

Figure 3.48 Kinetic Back-Up, Trip with Recovery, Trip Slow Ramp where Mains Return below
Parameter 14-15 Kin. Back-up Trip Recovery Level, here a Slow Ramp is Used

If the ramp is quicker than the ramp-down speed of the application, the ramping generates current. This results in a higher U_{DC} , which is limited using the brake chopper/resistor brake.

14-10 Mains Failure

Option: **Function:**

A	Normal operation.
B	Mains failure.
C	Kinetic back-up.
D	Mains return.
E	Kinetic back-up ramping to trip.
F	Trip.

Figure 3.49 Kinetic Back-Up, Trip with Recovery where Mains Return below
Parameter 14-15 Kin. Back-up Trip Recovery Level, here a Quick Ramp is Used

NOTICE!

For best performance of controlled ramp down and kinetic back-up, set *parameter 1-03 Torque Characteristics* to [0] Compressor or [1] Variable Torque (no automatic energy optimization should be active).

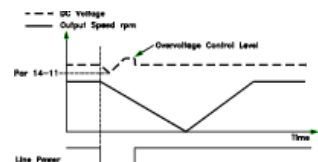

Figure 3.50 Controlled Ramp Down, Short Mains Failure.

Figure 3.50 shows ramping down to a stop followed by ramping up to the reference.

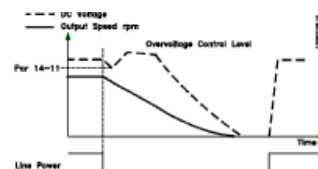

Figure 3.51 Controlled Ramp Down, Longer Mains Failure.

Figure 3.51 shows ramping down as long as the energy in the system allows it, then the motor coasts.

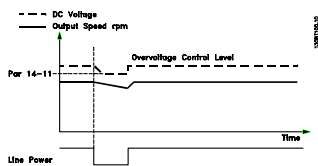

Figure 3.52 Kinetic Back-up, Short Mains Failure

Figure 3.52 shows riding through as long as the energy in the system allows it.

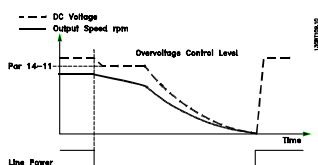

Figure 3.53 Kinetic Back-up, Longer Mains Failure

Figure 3.53 shows the motor coasting when the energy in the system is too low.

14-11 Mains Fault Voltage Level		
Range:	Function:	
Size related*	[180 - 600 V]	This parameter defines the threshold voltage at which the selected function in <i>parameter 14-10 Mains Failure</i> should be activated. The detection level is at a factor ² of the value in <i>parameter 14-11 Mains Fault Voltage Level</i> .

14-12 Response to Mains Imbalance		
Option:	Function:	
		Operation under severe mains imbalance conditions reduces the lifetime of the motor. Conditions are considered severe if the motor is operated continuously near nominal load (for example a pump or fan running near full speed). When a severe mains imbalance is detected, select 1 of the available functions.
[0]	Trip	Trips the frequency converter.
[1]	Warning	Issues a warning.
[2]	Disabled	No action.
[3] *	Derate	Derates the frequency converter.

14-16 Kin. Back-up Gain		
Range:	Function:	
100 %*	[0 - 500 %]	Enter the kinetic back-up gain value in percent.

3.13.3 14-2* Trip Reset

Parameters for configuring auto reset handling, special trip handling, and control card self-test or initialization.

14-20 Reset Mode		
Option:	Function:	
		NOTICE! The motor may start without warning. If the specified number of automatic resets is reached within 10 minutes, the frequency converter enters [0] <i>Manual reset</i> mode. After the manual reset is performed, the setting in <i>parameter 14-20 Reset Mode</i> reverts to the original selection. If the number of automatic resets is not reached within 10 minutes, or when a manual reset is performed, the internal automatic reset counter returns to 0.
[0] *		
[1]		
[2]		
[3]		
[4]		
[5]		
[6]		
[7]		
[8]		
[9]		
[10]		
[11]		
[12]		
[13]		Select the reset function after tripping. Once reset, the frequency converter can be restarted. Select [0] <i>Manual reset</i> to perform a reset via [Reset] or via the digital inputs. Select [1]-[12] <i>Automatic reset x 1...x20</i> to perform 1–20 automatic resets after tripping. Select [13] <i>Infinite Automatic Reset</i> for continuous resetting after tripping.
[14]		

14-21 Automatic Restart Time		
Range:	Function:	
10 s*	[0 - 600 s]	Enter the time interval from trip to start of the automatic reset function. This parameter is active when <i>parameter 14-20 Reset Mode</i> is set to [1]-[13] <i>Automatic reset</i> .

14-22 Operation Mode		
Option:	Function:	
		<p>Use this parameter to specify normal operation, to perform tests, or to initialize all parameters except:</p> <ul style="list-style-type: none"> Parameter 15-03 Power Up's. Parameter 15-04 Over Temp's. Parameter 15-05 Over Volt's. <p>This function is active only when the power is cycled (power off/power on) to the frequency converter.</p>
[0] *	Normal operation	Normal operation of the frequency converter with the motor in the selected application.
[1]	Control card test	<p>Tests the analog and digital inputs and outputs and the +10 V control voltage. The test requires a test connector with internal connections.</p> <p>Use the following procedure for the control card test:</p> <ol style="list-style-type: none"> Select [1] Control card test. Disconnect the mains supply and wait for the light in the display to go out. Set switches S201 (A53) and S202 (A54)=ON/I. Insert the test plug (see Figure 3.54). Connect to mains supply. Carry out various tests. The results are shown in the display and the frequency converter moves into an infinite loop. Parameter 14-22 Operation Mode is automatically set to [0] Normal operation. Carry out a power cycle to start up in normal operation after a control card test. <p>If the test is OK LCP readout: Control card OK. Disconnect the mains supply and remove the test plug. The green LED on the control card lights up.</p> <p>If the test fails LCP readout: Control card I/O failure. Replace the frequency converter or control card. The red indicator light on the control card is turned on. To test the plugs, connect/group the following terminals as shown in Figure 3.54:</p> <ul style="list-style-type: none"> (18, 27, and 32) (19, 29, and 33) (42, 53, and 54)

14-22 Operation Mode		
Option:	Function:	
		<p>Figure 3.54 Wiring Control Card Test</p>
[2]	Initialisation	<p>Resets all parameter values to default settings except:</p> <ul style="list-style-type: none"> Parameter 15-03 Power Up's. Parameter 15-04 Over Temp's. Parameter 15-05 Over Volt's. <p>The frequency converter resets during the next power-up. Parameter 14-22 Operation Mode also reverts to the default setting [0] Normal operation.</p>
[3]	Boot mode	
[5]	Clear service logs	

14-24 Trip Delay at Current Limit		
Range:	Function:	
60 s*	[0 - 60 s]	<p>Enter the current limit trip delay in s. When the output current reaches the current limit (parameter 4-18 Current Limit), a warning is triggered. When the current limit warning has been continuously present for the period specified in this parameter, the frequency converter trips. To run continuously in current limit without tripping, set the parameter to 60 s. Thermal monitoring of the frequency converter remains active.</p>

14-25 Trip Delay at Torque Limit		
Range:	Function:	
60 s* [0 - 60 s]	Enter the torque limit trip delay in s. When the output torque reaches the torque limits (<i>parameter 4-16 Torque Limit Motor Mode</i> and <i>parameter 4-17 Torque Limit Generator Mode</i>), a warning is triggered. When the torque limit warning has been continuously present for the period specified in this parameter, the frequency converter trips. Disable the trip delay by setting the parameter to 60 s=OFF. Thermal frequency converter monitoring remains active.	

14-26 Trip Delay at Inverter Fault		
Range:	Function:	
Size related* [0 - 35 s]	When the frequency converter detects an overvoltage in the set time, trip is effected after the set time.	

3.13.4 14-3* Current Limit Control

The frequency converter features an integral current limit controller, which is activated when the motor current, and thus the torque, is higher than the torque limits set in *parameter 4-16 Torque Limit Motor Mode* and *parameter 4-17 Torque Limit Generator Mode*. When the current limit is reached during motor operation or regenerative operation, the frequency converter tries to reduce torque below the preset torque limits as quickly as possible without losing control of the motor. While the current control is active, the frequency converter can only be stopped by setting a digital input to [2] *Coast inverse* or [3] *Coast and reset inv.* Any signal on terminals 18–33 are not active until the frequency converter is no longer near the current limit. By using a digital input set to [2] *Coast inverse* or [3] *Coast and reset inv.*, the motor does not use the ramp-down time, since the frequency converter is coasted.

14-30 Current Lim Ctrl, Proportional Gain		
Range:	Function:	
100 %* [5 - 500 %]	Enter the proportional gain value for the current limit controller. Selection of a high value makes the controller react faster. Too high a setting leads to controller instability.	

14-31 Current Lim Ctrl, Integration Time		
Range:	Function:	
Size related* [0.002 - 2 s]	Controls the current limit control integration time. Setting it to a lower	

14-31 Current Lim Ctrl, Integration Time		
Range:	Function:	
	value makes it react faster. A setting too low leads to controller instability.	

14-32 Current Lim Ctrl, Filter Time		
Range:	Function:	
Size related* [1 - 100 ms]	Sets a time constant for the current limit controller low-pass filter.	

3.13.5 14-4* Energy Optimizing

Parameters for adjusting the energy optimization level in both variable torque (VT) and automatic energy optimization (AEO) mode.

Automatic energy optimization is only active if *parameter 1-03 Torque Characteristics* is set to either [2] *Auto Energy Optim. CT* or [3] *Auto Energy Optim. VT*.

14-40 VT Level		
Range:	Function:	
66 %* [40 - 90 %]	<p>NOTICE! This parameter cannot be adjusted while the motor is running.</p> <p>NOTICE! This parameter is not active when <i>parameter 1-10 Motor Construction</i> is set to [1] <i>PM, non-salient SPM</i>.</p> <p>Enter the level of motor magnetization at low speed. Selection of a low value reduces energy loss in the motor, but also reduces load capability.</p>	

14-41 AEO Minimum Magnetisation		
Range:	Function:	
Size related* [30 - 200 %]	<p>NOTICE! This parameter is not active when <i>parameter 1-10 Motor Construction</i> is set to [1] <i>PM, non-salient SPM</i>.</p> <p>Enter the minimum allowable magnetization for AEO. Selection of a low value reduces energy loss in the motor, but can also reduce resistance to sudden load changes.</p>	

14-42 Minimum AEO Frequency		
Range:		Function:
Size related*	[0 - 40 Hz]	<p>NOTICE!</p> <p>This parameter is not active when <i>parameter 1-10 Motor Construction</i> is set to [1] PM, non-salient SPM.</p> <p>Enter the minimum frequency at which the automatic energy optimization (AEO) is to be active.</p>

14-43 Motor Cos-Phi		
Range:		Function:
0.66 N/A*	[0.40 - 0.95 N/A]	<p>NOTICE!</p> <p>This parameter is not active when <i>parameter 1-10 Motor Construction</i> is set to [1] PM, non-salient SPM.</p> <p>The Cos(phi) setpoint is automatically set to optimum AEO performance during AMA. Under normal circumstances, do NOT alter this parameter. However, in some situations it may be necessary to enter a new value to fine-tune.</p>

3.13.6 14-5* Environment

NOTICE!

Perform a power cycle after changing any of the parameters in *parameter group 14-5* Environment*.

These parameters help the frequency converter to operate under special environmental conditions.

14-50 RFI 1		
Option:		Function:
[0]	Off	Select [0] Off only when the frequency converter is supplied from an isolated mains source, that is, IT mains. In this mode, the internal RFI capacities (filter capacitors) between chassis and the mains RFI filter circuit is cut off to avoid damage to the DC link and to reduce the ground capacity currents (according to IEC 61800-3).
[1]	* On	Select [1] On to ensure that the frequency converter complies with EMC standards.

14-51 DC-Link Compensation		
Option:		Function:
		The rectified AC-DC voltage in the frequency converter's DC link is associated with voltage ripples. These ripples can increase in magnitude with increased load. These ripples are undesirable because they can generate

14-51 DC-Link Compensation		
Option:		Function:
		current and torque ripples. A compensation method is used to reduce these voltage ripples in the DC link. In general, DC-link compensation is recommended for most applications, but pay attention when operating in field weakening as it can generate speed oscillations at the motor shaft. In field weakening, turn off DC-link compensation.
[0]	Off	Disables DC-link compensation.
[1]	On	Enables DC-link compensation.

14-52 Fan Control		
Option:		Function:
		Select the minimum speed of the main fan.
[0]	* Auto	Select [0] Auto to run the fan only when the internal temperature of the frequency converter is in the range 35 °C (95 °F) to approximately 55 °C (131 °F). The fan runs at low speed at 35 °C (95 °F) and at full speed at approximately 55 °C (131 °F).
[1]	On 50%	
[2]	On 75%	
[3]	On 100%	
[4]	Auto (Low temp env.)	

14-53 Fan Monitor		
Option:		Function:
		Select the frequency converter action if a fan fault is detected.
[0]	Disabled	
[1]	* Warning	
[2]	Trip	

14-55 Output Filter		
Option:		Function:
		<p>NOTICE!</p> <p>This parameter cannot be adjusted while the motor is running.</p> <p>Select the type of output filter connected.</p>
[0]	* No Filter	
[1]	Sine-Wave Filter	

14-56 Capacitance Output Filter		
Enter the capacitance of the output filter. Find the value on the filter label. For the compensation function of the LC filter in the star connection, enter the per phase equivalent capacitance of the filter (3 times the capacitance between 2 phases in the delta connection).		
Range:	Function:	
2.0 uF*	[0.1 - 6500.0 uF]	Enter the capacitance of the output filter.

14-57 Inductance Output Filter		
Range:	Function:	
7.000 mH*	[0.001 - 65.000 mH]	Set the inductance of the output filter. The value can be found on the filter label.

14-58 Voltage Gain Filter		
Range:	Function:	
100 %*	[0 - 200 %]	Select the gain applied to the voltage when using an LC filter.

14-59 Actual Number of Inverter Units		
This parameter is only relevant for high-power frequency converters.		
Range:	Function:	
Size related*	[1 - 1]	Sets the actual number of operating inverter units.

3.13.7 14-6* Auto Derate

This group contains parameters for derating the frequency converter if there is high temperature.

14-60 Function at Over Temperature		
If either heat sink or control card temperature exceeds a programmed temperature limit, a warning is activated. If the temperature increases further, select whether the frequency converter should trip (trip lock) or derate the output current.		
Option:	Function:	
[0]	Trip	The frequency converter trips (trip lock) and generates an alarm. Cycle power to reset the alarm, but it does not allow restart of the motor until the heat sink temperature has dropped below the alarm limit.
[1] *	Derate	If the critical temperature is exceeded, the output current is reduced until the allowable temperature has been reached.

3.13.8 No Trip at Inverter Overload

In some pump systems, the frequency converter has not been sized properly to yield the current needed in all points of the operational flow-head characteristic. At these points, the pump needs a current higher than the rated current of the frequency converter. The frequency converter can yield 110% of the rated current continuously for 60 s. If still overloaded, the frequency converter normally trips (causing the pump to stop by coasting) and issues an alarm.

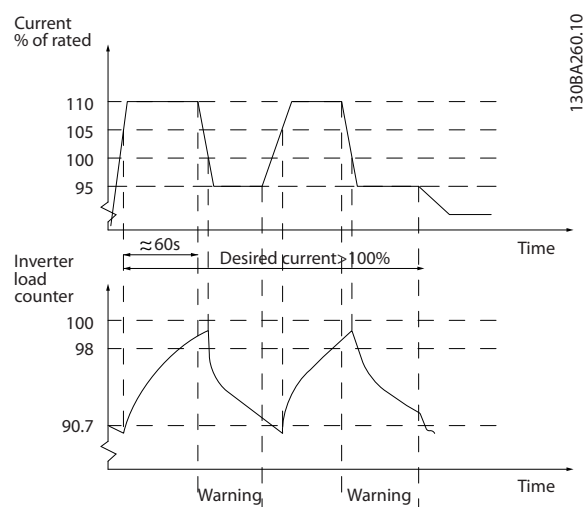

Figure 3.55 Output Current in Overload Condition

If the pump is unable to run continuously with the demanded capacity, run it at reduced speed for a while.

Select *parameter 14-61 Function at Inverter Overload* to automatically reduce pump speed until the output current is below 100% of the rated current (set in *parameter 14-62 Inv. Overload Derate Current*). *Parameter 14-61 Function at Inverter Overload* is an alternative to letting the frequency converter trip.

The frequency converter estimates the load on the power section with an inverter load counter, which causes a warning at 98% and a reset of the warning at 90%. At the value 100%, the frequency converter trips and issues an alarm.

Status for the counter can be read in *parameter 16-35 Inverter Thermal*.

If *parameter 14-61 Function at Inverter Overload* is set to [3] *Derate*, the pump speed is reduced when the counter exceeds 98%, and stays reduced until the counter has dropped below 90.7%.

If parameter 14-62 Inv. Overload Derate Current is set to for example 95%, a steady overload causes the pump speed to fluctuate between values corresponding to 110% and 95% of rated output current for the frequency converter.

14-61 Function at Inverter Overload		
Is used if there is steady overload beyond the thermal limits (110% for 60 s).		
Option:		Function:
[0]	Trip	The frequency converter trips and issues an alarm.
[1] *	Derate	Reduces pump speed to decrease the load on the power section, allowing this to cool down.

14-62 Inv. Overload Derate Current		
Range:	Function:	
95 %*	[50 - 100 %]	Enter the current level (in % of rated output current for the frequency converter) when running with reduced pump speed after load on the frequency converter has exceeded the allowable limit (110% for 60 s).

3.13.9 14-8* Options

14-80 Option Supplied by External 24VDC		
Option:	Function:	
	NOTICE! This parameter is only changing function by performing a power cycle.	

14-80 Option Supplied by External 24VDC		
Option:	Function:	
[0]	No	Select [0] No to use the frequency converter's 24 V DC supply.
[1] *	Yes	Select [1] Yes if a 24 V DC external supply is used to power the option. Inputs/outputs are galvanically isolated from the frequency converter when operated from an external supply.

3.13.10 14-9* Fault Settings

14-90 Fault Level		
Array [21]		
Option:	Function:	
[0]	Off	Use this parameter to customize fault levels. Use [0] Off with caution as it ignores all warnings and alarms for the selected source.
[1]	Warning	
[2]	Trip	
[3]	Trip Lock	
[4]	Trip w. delayed reset	

Failure	Parameter	Alarm	Off	Warning	Trip	Trip lock	Trip with delayed reset
10 V low	1490.0	1	X	D	-	-	-
24 V low	1490.1	47	X	-	-	D	-
1.8 V supply low	1490.2	48	X	-	-	D	-
Voltage limit	1490.3	64	X	D	-	-	-
Ground fault	1490.4 ¹⁾	14	-	-	D	X	-
Ground fault 2	1490.5 ¹⁾	45	-	-	D	X	-
Torque limit	1490.6	12	X	D	-	-	-
Overcurrent	1490.7	13	-	-	-	D	X
Short circuit	1490.8	16	-	-	X	D	-
Heat sink temp.	1490.9	29	-	-	X	D	-
Heat sink sensor	1490.10	39	-	-	X	D	-
Control card temp.	1490.11	65	-	-	X	D	-
Power card temp.	1490.12	69	-	-	X	D	-
Heat sink temp.	1490.13 ³⁾	244	-	-	X	D	-
Heat sink sensor	1490.14 ³⁾	245	-	-	X	D	-
Power card temp.	1490.15 ³⁾	247	-	-	X	D	-
Derag limit fault	1490.16 ^{1), 2)}	100	-	-	D	X	-

Table 3.22 Possible Actions when Selected Alarm Appears

D = Default setting. X = Possible selection.

1) Only these faults are configurable on the FC 202. Due to a software limitation with array parameters, all others are shown in the MCT 10 Set-up Software. For the other parameter indices, writing any other value than its current value (that is, the default value) returns a value-out-of-range error. Thus, it is not allowed to change the fault level for the non-configurable ones.

2) This parameter has been 1490.6 in all firmware versions up to 1.86.

3) Alarm 244, Heat sink temp., alarm 245, Heat sink sensor, and alarm 247, Power card temp. are used for multiple power cards.

3.14 Parameters 15-** Drive Information

Parameter group containing frequency converter information such as operating data, hardware configuration, and software versions.

3.14.1 15-0* Operating Data

15-00 Operating hours		
Range:	Function:	
0 h* [0 - 2147483647 h]	View how many hours the frequency converter has run. The value is saved when the frequency converter is turned off.	

15-01 Running Hours		
Range:	Function:	
0 h* [0 - 2147483647 h]	View how many hours the motor has run. Reset the counter in <i>parameter 15-07 Reset Running Hours Counter</i> . The value is saved when the frequency converter is turned off.	

15-02 kWh Counter		
Range:	Function:	
0 kWh* [0 - 2147483647 kWh]	Register the power consumption of the motor as an average value over 1 hour. Reset the counter in <i>parameter 15-06 Reset kWh Counter</i> .	

15-03 Power Up's		
Range:	Function:	
0* [0 - 2147483647]	View the number of times the frequency converter has been powered up.	

15-04 Over Temp's		
Range:	Function:	
0* [0 - 65535]	View the number of frequency converter temperature faults.	

15-05 Over Volt's		
Range:	Function:	
0* [0 - 65535]	View the number of frequency converter overvoltages.	

15-06 Reset kWh Counter		
Option:	Function:	
[0] * Do not reset	No reset of the kWh counter is required.	
[1] Reset counter	Press [OK] to reset the kWh counter to 0 (see <i>parameter 15-02 kWh Counter</i>).	

15-07 Reset Running Hours Counter		
Option:	Function:	
[0] * Do not reset	No reset of the running hours counter is required.	
[1] Reset counter	Select [1] <i>Reset counter</i> and press [OK] to reset the running hours counter (<i>parameter 15-01 Running Hours</i>) and <i>parameter 15-08 Number of Starts</i> to 0 (see also <i>parameter 15-01 Running Hours</i>).	

15-08 Number of Starts		
Range:	Function:	
0* [0 - 2147483647]	<p>NOTICE!</p> <p>This parameter is reset when resetting <i>parameter 15-07 Reset Running Hours Counter</i>.</p> <p>This is a readout parameter only. The counter shows the number of starts and stops caused by a normal start/stop command and/or when entering/leaving sleep mode.</p>	

3.14.2 15-1* Data Log Settings

The data log enables continuous logging of up to 4 data sources (*parameter 15-10 Logging Source*) at individual rates (*parameter 15-11 Logging Interval*). A trigger event (*parameter 15-12 Trigger Event*) and window (*parameter 15-14 Samples Before Trigger*) are used to start and stop the logging conditionally.

15-10 Logging Source		
Option:	Function:	
[0] * None		
[1472]		
[1473]		
[1474]		
[1600]	Control Word	
[1601]	Reference [Unit]	
[1602]	Reference %	
[1603]	Status Word	
[1610]	Power [kW]	
[1611]	Power [hp]	
[1612]	Motor voltage	
[1613]	Frequency	
[1614]	Motor Current	
[1616]	Torque [Nm]	
[1617]	Speed [RPM]	
[1618]	Motor Thermal	

15-10 Logging Source		
Array [4]		
Option:	Function:	
[1622]	Torque [%]	
[1625]		
[1630]	DC Link Voltage	
[1632]	Brake Energy /s	
[1633]	Brake Energy /2 min	
[1634]	Heatsink Temp.	
[1635]	Inverter Thermal	
[1650]	External Reference	
[1651]	Pulse Reference	
[1652]	Feedback [Unit]	
[1660]	Digital Input	
[1662]	Analog Input 53	
[1664]	Analog Input 54	
[1665]	Analog Output 42 [mA]	
[1666]	Digital Output [bin]	
[1675]	Analog In X30/11	
[1676]	Analog In X30/12	
[1677]	Analog Out X30/8 [mA]	
[1690]	Alarm Word	
[1692]	Warning Word	
[1694]	Ext. Status Word	
[3470]	MCO Alarm Word 1	
[3471]	MCO Alarm Word 2	

15-11 Logging Interval		
Array [4]		
Range:	Function:	
Size related*	[0 - 0]	Enter the interval in ms between each sampling of the variables to be logged.

15-12 Trigger Event		
Option:	Function:	
		Selects the trigger event. When the trigger event occurs, a window is applied to freeze the log. The log then retains a specified percentage of samples before the occurrence of the trigger event (parameter 15-14 Samples Before Trigger).
[0] *	False	
[1]	True	
[2]	Running	
[3]	In range	
[4]	On reference	
[5]	Torque limit	
[6]	Current Limit	
[7]	Out of current range	

15-12 Trigger Event		
Option:	Function:	
[8]	Below I low	
[9]	Above I high	
[10]	Out of speed range	
[11]	Below speed low	
[12]	Above speed high	
[13]	Out of feedb. range	
[14]	Below feedb. low	
[15]	Above feedb. high	
[16]	Thermal warning	
[17]	Mains out of range	
[18]	Reversing	
[19]	Warning	
[20]	Alarm (trip)	
[21]	Alarm (trip lock)	
[22]	Comparator 0	
[23]	Comparator 1	
[24]	Comparator 2	
[25]	Comparator 3	
[26]	Logic rule 0	
[27]	Logic rule 1	
[28]	Logic rule 2	
[29]	Logic rule 3	
[33]	Digital input DI18	
[34]	Digital input DI19	
[35]	Digital input DI27	
[36]	Digital input DI29	
[37]	Digital input DI32	
[38]	Digital input DI33	
[50]	Comparator 4	
[51]	Comparator 5	
[60]	Logic rule 4	
[61]	Logic rule 5	

15-13 Logging Mode		
Option:	Function:	
[0] *	Log always	Select [0] Log always for continuous logging.
[1]	Log once on trigger	Select [1] Log once on trigger to start and stop logging conditionally using parameter 15-12 Trigger Event and parameter 15-14 Samples Before Trigger.

15-14 Samples Before Trigger		
Range:	Function:	
50*	[0 - 100]	Enter the percentage of all samples to be retained in the log before a trigger event occurs. See also parameter 15-12 Trigger Event and parameter 15-13 Logging Mode.

3.14.3 Service Log

The service log functionality saves detailed log information of a 5-second interval in cases when certain alarms occur. Service technicians can analyze this information to troubleshoot and optimize the frequency converter.

The frequency converter can save up to 24 service log records in the flash memory.

Find the list of alarms that trigger a service log record in *chapter 3.14.6 Alarms that Trigger a Service Log Record*. Application-dependent trips/alarms, for example, Safe Torque Off, do not trigger a service log record.

Sampling rate

There are 2 periods with different sampling rates:

- Slow samples: 20 samples at a rate of 250 ms resulting in 5 s of history before the trip.
- Fast samples: 50 samples at a rate of 5 ms resulting in 250 ms of detailed history before the trip.

NOTICE!

To enable the real-time clock (RTC) stamp, use the real-time clock module. If real-time clock is not available, the operating time in *parameter 15-32 Fault Log: Time* is recorded.

The service log contains the elements shown in *Table 3.23*.

#	Alarm log data	Parameter number
1	Time of trip (1 of the values): <ul style="list-style-type: none"> • Priority real-time clock (if available). • Priority operating time (if RTC is not available). 	<i>Parameter 0-89 Date and Time Readout or parameter 15-32 Fault Log: Time</i>
2	Alarm code	<i>Parameter 15-30 Fault Log: Error Code</i>
3	Frequency	<i>Parameter 16-13 Frequency</i>
4	Speed (RPM)	<i>Parameter 16-17 Speed [RPM]</i>
5	Reference (%)	<i>Parameter 16-02 Reference %</i>
7	DC-link voltage	<i>Parameter 16-30 DC Link Voltage</i>
9	Motor phase U current	<i>Parameter 16-45 Motor Phase U Current</i>
10	Motor phase V current	<i>Parameter 16-46 Motor Phase V Current</i>
11	Motor phase W current	<i>Parameter 16-47 Motor Phase W Current</i>
12	Motor phase voltage	<i>Parameter 16-12 Motor voltage</i>
15	Control word	<i>Parameter 16-00 Control Word</i>
16	Status word	<i>Parameter 16-03 Status Word</i>

Table 3.23 Service Log Data

3

3.14.4 Clearing the Service Log

The flash memory stores up to 24 records. To save more logs, clear the service log memory.

To clear the service log:

1. In *parameter 14-22 Operation Mode*, select option [5] *Clear Service Log*.
2. Power cycle the frequency converter. Clearing the service log extends the power-up time by approximately 1 s.

Save the service log records using the MCT 10 Set-up Software before clearing the service log.

Clear the service log after a commissioning to remove any alarms that occurred during the testing.

Service log indication

Parameter 16-42 Service Log Counter shows the number of service logs stored in the memory.

The frequency converter indicates a full service log memory in 1 of the following ways:

- The LCP shows the message:
Clear logs Service log full: 28 [M26]
- Bit 25 is set high in *parameter 16-96 Maintenance Word* (0x2000000).

Performing the frequency converter initialization does not clear the service log memory.

3.14.5 Reading the Service Log Information

Use MCT 10 Set-up Software to read the service log information.

To read the service information:

1. Open MCT 10 Set-up Software.
2. Select a frequency converter.
3. Select the Service Log plug-in.
4. Click *Read from drive*.

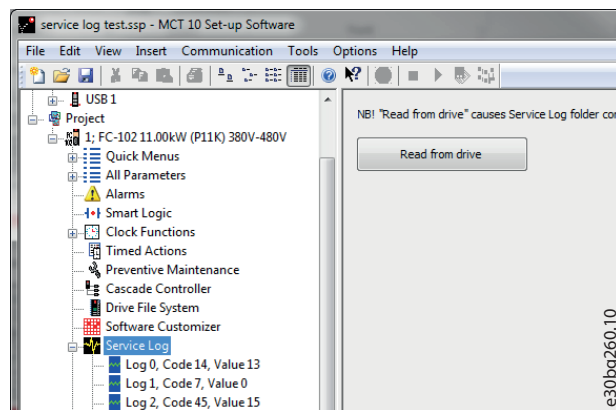

Figure 3.56 MCT 10, Read from Drive

Figure 3.57 shows the service log view in MCT 10 Set-up Software. Use the cursor to view the detailed readings at a specific time.

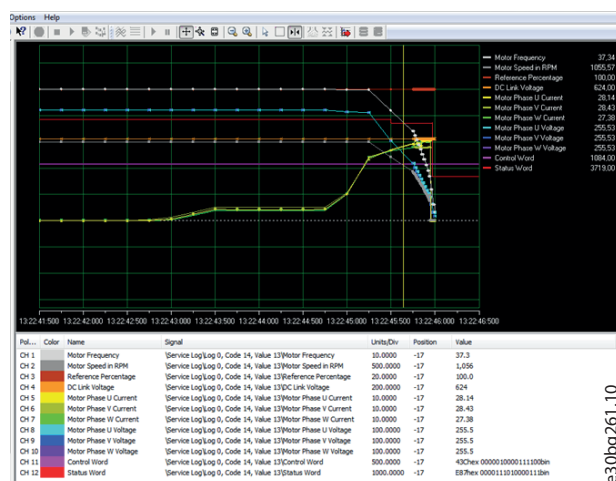

Figure 3.57 Service Log View, 5 s

Use the zoom function to focus on the last 250 ms before the fault. See Figure 3.58.

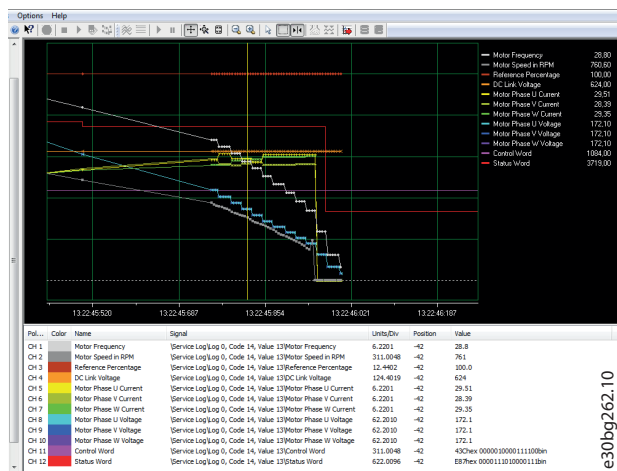

Figure 3.58 Service Log Detailed View, 250 ms

3.14.6 Alarms that Trigger a Service Log Record

#	Alarm title
4	Mains phase loss
5	DC voltage high
6	DC voltage low
7	DC overvolt
8	DC undervolt
9	Inverter overld.
10	Motor ETR over
12	Torque limit
13	Over Current
14	Earth (ground) Fault
16	Short Circuit
18	Start Failed
25	Brake resistor
26	Brake overload
27	Brake IGBT
28	Brake check
30	U phase loss
31	V phase loss
32	W phase loss
36	Mains failure
37	Phase imbalance
44	Earth (ground) Fault AL44
45	Earth (ground) Fault 2
59	Current limit

Table 3.24 Alarms that Trigger a Service Log Record

NOTICE!

If an alarm has 2 states (warning/alarm), it only triggers a service log record when going into the alarm state.

3.14.7 15-2* Historic Log

View up to 50 logged data items via the array parameters in this parameter group. Data is logged every time an event occurs (not to be confused with SLC events). Events in this context are defined as a change in 1 of the following areas:

- Digital inputs.
- Digital outputs.
- Warning word.
- Alarm word.
- Status word.
- Control word.
- Extended status word.

Events are logged with value and time stamp in ms. The time interval between 2 events depends on how often events occur (maximum once every scan time). Data logging is continuous, but if an alarm occurs, the log is saved and the values can be viewed on the display. This feature is useful, for example when carrying out service following a trip. View the historic log contained in this parameter via the serial communication port or via the display.

15-20 Historic Log: Event

Array [50]

Range: Function:

0* [0 - 255] View the event type of the logged events.

15-21 Historic Log: Value

Array [50]

Range: Function:

0* [0 - 2147483647] View the value of the logged event. Interpret the event values according to Table 3.25:

Digital input	Decimal value. See parameter 16-60 Digital Input for description after converting to binary value.
Digital output (not monitored in this SW release)	Decimal value. See parameter 16-66 Digital Output [bin] for a description after converting to binary value.
Warning word	Decimal value. See parameter 16-92 Warning Word for a description.
Alarm word	Decimal value. See parameter 16-90 Alarm Word for a description.

15-21 Historic Log: Value			
Array [50]			
Range:		Function:	
	Status word	Decimal value. See <i>parameter 16-03 Status Word</i> for a description after converting to binary value.	
	Control word	Decimal value. See <i>parameter 16-00 Control Word</i> for a description.	
	Extended status word	Decimal value. See <i>parameter 16-94 Ext. Status Word</i> for a description.	
Table 3.25 Logged Events			

15-22 Historic Log: Time			
Array [50]			
Range:		Function:	
0 ms*	[0 - 2147483647 ms]	View the time at which the logged event occurred. Time is measured in ms since frequency converter start. The maximum value corresponds to approximately 24 days, which means that the count restarts at 0 after this time period.	

15-23 Historic log: Date and Time			
Array [50]			
Range:		Function:	
Size related*	[0 - 0]	Array parameter; Date & Time 0–49: This parameter shows when the logged event occurred.	

3.14.8 15-3* Alarm Log

Parameters in this group are array parameters where up to 10 fault logs can be viewed. 0 is the most recent logged data, and 9 is the oldest. Fault codes, values, and time stamp can be viewed for all logged data.

15-30 Alarm Log: Error Code			
Array [10]			
Range:		Function:	
0*	[0 - 65535]	View the fault code and look up its meaning in <i>chapter 5 Troubleshooting</i> .	

15-31 Alarm Log: Value			
Array [10]			
Range:		Function:	
0*	[-32767 - 32767]	View an extra description of the error. This parameter is mostly used with <i>alarm 38, internal fault</i> .	

15-32 Alarm Log: Time			
Array [10]			
Range:		Function:	
0 s*	[0 - 2147483647 s]	View the time when the logged event occurred. Time is measured in s from frequency converter start-up.	

15-33 Alarm Log: Date and Time			
Array [10]			
Range:		Function:	
Size related*	[0 - 0]	Array parameter; Date & Time 0–9: This parameter shows when the logged event occurred.	

15-34 Alarm Log: Setpoint			
Array [10]			
Range:		Function:	
0 ProcessCtrlUnit*	[-999999.999 - 999999.999 ProcessCtrlUnit]	Array parameter; status value 0–9. This parameter shows the status of the alarm: 0: Alarm inactive. 1: Alarm active.	

15-35 Alarm Log: Feedback			
Array [10]			
Range:		Function:	
0 ProcessCtrlUnit*	[-999999.999 - 999999.999 ProcessCtrlUnit]		

15-36 Alarm Log: Current Demand			
Array [10]			
Range:		Function:	
0 %*	[0 - 100 %]		

15-37 Alarm Log: Process Ctrl Unit			
Array [10]			
Option:		Function:	
[0] *			
[1]	%		
[5]	PPM		
[10]	1/min		
[11]	RPM		

15-37 Alarm Log: Process Ctrl Unit		
Array [10]		
Option:	Function:	
[12]	Pulse/s	
[20]	l/s	
[21]	l/min	
[22]	l/h	
[23]	m ³ /s	
[24]	m ³ /min	
[25]	m ³ /h	
[30]	kg/s	
[31]	kg/min	
[32]	kg/h	
[33]	t/min	
[34]	t/h	
[40]	m/s	
[41]	m/min	
[45]	m	
[60]	°C	
[70]	mbar	
[71]	bar	
[72]	Pa	
[73]	kPa	
[74]	m WG	
[75]	mm Hg	
[80]	kW	
[120]	GPM	
[121]	gal/s	
[122]	gal/min	
[123]	gal/h	
[124]	CFM	
[125]	ft ³ /s	
[126]	ft ³ /min	
[127]	ft ³ /h	
[130]	lb/s	
[131]	lb/min	
[132]	lb/h	
[140]	ft/s	
[141]	ft/min	
[145]	ft	
[160]	°F	
[170]	psi	
[171]	lb/in ²	
[172]	in WG	
[173]	ft WG	
[174]	in Hg	
[180]	HP	

3.14.9 15-4* Drive Identification

Parameters containing read-only information about the hardware and software configuration of the frequency converter.

15-40 FC Type		
Range:	Function:	
0 N/A*	[0 - 0 N/A]	View the FC type. The readout is identical to the power field of the type code definition, characters 1–6.

15-41 Power Section		
Range:	Function:	
0 N/A*	[0 - 0 N/A]	View the FC type. The readout is identical to the power field of the type code definition, characters 7–10.

15-42 Voltage		
Range:	Function:	
0 N/A*	[0 - 0 N/A]	View the FC type. The readout is identical to the power field of the type code definition, characters 11–12.

15-43 Software Version		
Range:	Function:	
0*	[0 - 5]	View the combined SW version (or package version) consisting of power SW and control SW.

15-44 Ordered Typecode String		
Range:	Function:	
0*	[0 - 40]	View the type code string used for reordering the frequency converter in its original configuration.

15-45 Actual Typecode String		
Range:	Function:	
0*	[0 - 40]	View the actual type code string.

15-46 Frequency Converter Ordering No		
Range:	Function:	
0*	[0 - 8]	View the 8-digit ordering number used for reordering the frequency converter in its original configuration. To restore the ordering number after the power card exchange, see <i>parameter 14-29 Service Code</i> .

15-47 Power Card Ordering No		
Range:	Function:	
0*	[0 - 8]	View the power card ordering number.

15-48 LCP Id No		
Range:	Function:	
0*	[0 - 20]	View the LCP ID number.

15-49 SW ID Control Card		
Range:	Function:	
0*	[0 - 20]	View the control card software version number.

15-50 SW ID Power Card		
Range:	Function:	
0*	[0 - 20]	View the power card software version number.

15-51 Frequency Converter Serial Number		
Range:	Function:	
0*	[0 - 10]	View the frequency converter serial number.

15-53 Power Card Serial Number		
Range:	Function:	
0*	[0 - 19]	View the power card serial number.

15-54 Config File Name		
Array [5]		
Range:	Function:	
Size related*	[0 - 16]	Shows the special configuration filenames.

15-58 SmartStart Filename		
Range:	Function:	
Size related*	[0 - 20]	Shows the SmartStart filename.

15-59 Filename		
Range:	Function:	
Size related*	[0 - 16]	Shows the currently used CSIV (costumer-specific initial values) filename.

3.14.10 15-6* Option Ident.

This read-only parameter group contains information about the hardware and software configuration of the options installed in slots A, B, C0, and C1.

15-60 Option Mounted		
Array [8]		
Range:	Function:	
0*	[0 - 30]	Shows the type of the installed option.

15-61 Option SW Version		
Array [8]		
Range:	Function:	
0*	[0 - 20]	View the installed option software version.

15-62 Option Ordering No		
Array [8]		
Range:	Function:	
0*	[0 - 8]	Shows the ordering number for the installed options.

15-63 Option Serial No		
Array [8]		
Range:	Function:	
0*	[0 - 18]	View the installed option serial number.

15-70 Option in Slot A		
Range:	Function:	
0*	[0 - 30]	View the type code string for the option installed in slot A, and a translation of the type code string. For example, type code string AX means no option.

15-71 Slot A Option SW Version		
Range:	Function:	
0*	[0 - 20]	View the software version for the option installed in slot A.

15-72 Option in Slot B		
Range:	Function:	
0*	[0 - 30]	View the type code string for the option installed in slot B, and a translation of the type code string. For example, for type code string BX, the translation is No option.

15-73 Slot B Option SW Version		
Range:	Function:	
0*	[0 - 20]	View the software version for the option installed in slot B.

15-74 Option in Slot C0/E0		
Range:	Function:	
0*	[0 - 30]	View the type code string for the option installed in slot C, and a translation of the type code string. For example, type code string CXXXX means no option.

15-75 Slot C0/E0 Option SW Version		
Range:	Function:	
0*	[0 - 20]	View the software version for the option installed in slot C.

15-76 Option in Slot C1/E1		
Range:	Function:	
0*	[0 - 30]	Shows the type code string for the options (CXXXX if there is no option).

15-77 Slot C1/E1 Option SW Version		
Range:	Function:	
0*	[0 - 20]	Software version for the installed option in option slot C.

15-80 Fan Running Hours		
Range:	Function:	
0 h*	[0 - 2147483647 h]	This parameter shows how many hours the external fan has run. The value is saved when the frequency converter is turned off.

3.14.11 15-9* Parameter Info

15-92 Defined Parameters		
Range:	Function:	
0*	[0 - 9999]	View a list of all defined parameters in the frequency converter. The list ends with 0.

15-93 Modified Parameters		
Range:	Function:	
0*	[0 - 9999]	View a list of the parameters that have been changed from their default setting. The list ends with 0. Changes may not be visible until up to 30 s after implementation.

15-98 Drive Identification		
Range:	Function:	
0*	[0 - 40]	

15-99 Parameter Metadata		
Array [30]		
Range:	Function:	
0*	[0 - 9999]	This parameter contains data used by the MCT 10 Set-up Software tool.

3.15 Parameters 16-** Data Readouts

3.15.1 16-0* General Status

16-00 Control Word		
Range:	Function:	
0* [0 - 65535]	View the control word sent from the frequency converter via the serial communication port in hex code.	

16-01 Reference [Unit]		
Range:	Function:	
0 ReferenceFeed-backUnit*	[-999999 - 999999 ReferenceFeed-backUnit]	View the present reference value applied on impulse or analog basis in the unit resulting from the configuration selected in <i>parameter 1-00 Configuration Mode</i> (Hz, Nm, or RPM).

16-02 Reference [%]		
Range:	Function:	
0 %* [-200 - 200 %]	View the total reference. The total reference is the sum of digital, analog, preset, bus, and freeze references, plus catch up and slow down.	

16-03 Status Word		
Range:	Function:	
0* [0 - 65535]	View the status word sent from the frequency converter via the serial communication port in hex code.	

16-05 Main Actual Value [%]		
Range:	Function:	
0.00 %* [-100.00 - 100.00 %]	View the 2 byte word sent with the status word to the fieldbus master reporting the main actual value. Refer to the <i>VLT® PROFIBUS DP MCA 101 Programming Guide</i> for further details.	

16-09 Custom Readout		
Range:	Function:	
0 CustomReadoutUnit*	[-999999.99 - 999999.99 CustomReadoutUnit]	View the user-defined readouts as defined in <i>parameter 0-30 Custom Readout Unit</i> , <i>parameter 0-31 Custom Readout Min Value</i> , and

16-09 Custom Readout		
Range:	Function:	
		<i>parameter 0-32 Custom Readout Max Value</i> .

3.15.2 16-1* Motor Status

16-10 Power [kW]		
Range:	Function:	
0 kW* [0 - 10000 kW]	Shows motor power in kW. The value shown is calculated based on the actual motor voltage and motor current. The value is filtered, and therefore approximately 1.3 s may pass from when an input value changes to when the data readout values change. The resolution of readout value on fieldbus is in 10 W steps.	

16-11 Power [hp]		
Range:	Function:	
0 hp* [0 - 10000 hp]	View the motor power in hp. The value shown is calculated based on the actual motor voltage and motor current. The value is filtered, and therefore approximately 1.3 ms may pass from when an input value changes to when the data readout values change.	

16-12 Motor Voltage		
Range:	Function:	
0 V* [0 - 6000 V]	View the motor voltage, a calculated value used for controlling the motor.	

16-13 Frequency		
Range:	Function:	
0 Hz* [0 - 6500 Hz]	View the motor frequency without resonance damping.	

16-14 Motor current		
Range:	Function:	
0 A* [0 - 10000 A]	View the motor current measured as an average value, I_{RMS} . The value is filtered, and thus approximately 1.3 s may pass from when an input value changes to when the data readout values change.	

16-15 Frequency [%]		
Range:	Function:	
0 %* [-100 - 100 %]	View a 2-byte word reporting the actual motor frequency (without resonance damping) as a percentage (scale 0000–4000 hex) of <i>parameter 4-19 Max Output Frequency</i> . Set <i>parameter 9-16 PCD Read Configuration index 1</i> to send it with the status word instead of the MAV.	

16-16 Torque [Nm]		
Range:	Function:	
0 Nm* [-30000 - 30000 Nm]	View the torque value with sign, applied to the motor shaft. Linearity is not exact between 110% motor current and torque in relation to the rated torque. Some motors supply more than 160% torque. Therefore, the minimum and the maximum values depend on the maximum motor current and the motor used. The value is filtered, and thus approximately 1.3 s may pass from when an input changes value to when the data readout values change.	

16-17 Speed [RPM]		
Range:	Function:	
0 RPM* [-30000 - 30000 RPM]	View the actual motor RPM.	

16-18 Motor Thermal		
Range:	Function:	
0 %* [0 - 100 %]	View the calculated thermal load on the motor. The cutout limit is 100%. The basis for calculation is the ETR function selected in <i>parameter 1-90 Motor Thermal Protection</i> .	

16-19 KTY sensor temperature		
Range:	Function:	
0 °C* [0 - 0 °C]	Returning the actual temperature on KTY sensor built into the motor. See <i>parameter group 1-9* Motor Temperature</i> .	

16-20 Motor Angle		
Range:	Function:	
0 N/A* [0 - 65535 N/A]	View the current encoder/resolver angle offset relative to the index position. The value range of 0–65535 corresponds to 0–2 π (radian).	

16-22 Torque [%]		
Range:	Function:	
0 % * [-200 - 200 %]	This is a readout parameter only.	

16-22 Torque [%]		
Range:	Function:	
	Shows the actual torque yielded in percentage of the rated torque, based on the setting of the motor size and rated speed in <i>parameter 1-20 Motor Power [kW]</i> or <i>parameter 1-21 Motor Power [HP]</i> , and <i>parameter 1-25 Motor Nominal Speed</i> . This is the value monitored by the broken-belt function set in <i>parameter group 22-6* Broken Belt Detection</i> .	

16-23 Motor Shaft Power [kW]		
Range:	Function:	
0 kW* [0 - 10000 kW]	Shows the power applied to the motor shaft. The shown value is an estimate based on the motor shaft torque and motor speed.	

16-24 Calibrated Stator Resistance		
Range:	Function:	
0.0000 Ohm* [0.0000 - 100.0000 Ohm]	Shows the calibrated stator resistance.	

16-26 Power Filtered [kW]		
Range:	Function:	
0 kW* [0 - 10000 kW]		

16-27 Power Filtered [hp]		
Range:	Function:	
0 hp* [0 - 10000 hp]		

3.15.3 16-3* Drive Status

16-30 DC Link Voltage		
Range:	Function:	
0 V* [0 - 10000 V]	View a measured value. The value is filtered with a 30 ms time constant.	

16-32 Brake Energy /s		
Range:	Function:	
0 kW* [0 - 10000 kW]	View the brake power transmitted to an external brake resistor, stated as an instant value.	

16-33 Brake Energy Average		
Range:	Function:	
0 kW* [0 - 10000 kW]	View the brake power transmitted to an external brake resistor. The mean power is calculated on an average level based on the selected time period within <i>parameter 2-13 Brake Power Monitoring</i> .	

16-34 Heatsink Temp.		
Range:	Function:	
0 °C* [0 - 255 °C]	View the frequency converter heat sink temperature. The cutout limit is 90 ±5 °C (194 ±9 °F), and the motor cuts back in at 60 ±5 °C (140 ±9 °F).	

16-35 Inverter Thermal		
Range:	Function:	
0 %* [0 - 100 %]	View the thermal load on the inverter. The cutout limit is 100%.	

16-36 Inv. Nom. Current		
Range:	Function:	
Size related* [0.01 - 10000 A]	View the inverter nominal current, which should match the nameplate data on the connected motor. The data is used for calculation of torque, motor overload protection, and so on.	

16-37 Inv. Max. Current		
Range:	Function:	
Size related* [0.01 - 10000 A]	View the inverter maximum current, which should match the nameplate data on the connected motor. The data is used for calculation of torque, motor overload protection, and so on.	

16-38 SL Controller State		
Range:	Function:	
0* [0 - 100]	View the state of the event under execution by the SL controller.	

16-39 Control Card Temp.		
Range:	Function:	
0 °C* [0 - 100 °C]	View the temperature on the control card, stated in °C.	

16-40 Logging Buffer Full		
Option:	Function:	
	View whether the logging buffer is full (see <i>chapter 3.14.2 15-1* Data Log Settings</i>). The logging	

16-40 Logging Buffer Full		
Option:	Function:	
	buffer is never full when <i>parameter 15-13 Logging Mode</i> is set to [0] Log always.	
[0] *	No	
[1]	Yes	

16-42 Service Log Counter		
Range:	Function:	
0* [0 - 24]	Shows the number of service logs stored in the ServiceLog file. If the ServiceLog file is full, clear the logged data by selecting option [5] <i>Clear service logs</i> in <i>parameter 14-22 Operation Mode</i> . The logged data is deleted on the next power-up.	

16-49 Current Fault Source		
Range:	Function:	
0* [0 - 8]	The value indicates source of current fault, including: <ul style="list-style-type: none"> • Short circuit. • Overcurrent. • Imbalance of supply voltage (from left): 1-4 – inverter, 5-8 – rectifier, 0 – no fault recorded. 	

After a short circuit alarm (I_{max2}), or overcurrent alarm (I_{max1}), or imbalance of supply voltage, this contains the power card number associated with the alarm. It only holds 1 number indicating the highest priority power card number (master first). The value persists on power cycle, but if a new alarm occurs it is overwritten by the new power card number (even if it is a lower priority number). The value is only cleared when the alarm log is cleared (that is a 3-finger reset would reset the readout to 0).

3.15.4 16-5* Ref. & Feedb.

16-50 External Reference		
Range:	Function:	
0* [-200 - 200]	View the total reference, the sum of digital, analog, preset, fieldbus, and freeze references, plus catch up and slow down.	

16-52 Feedback[Unit]		
Range:	Function:	
0 ProcessCtrlUnit*	[-999999.999 - 999999.999 ProcessCtrlUnit]	View value of resulting feedback value after processing of feedback 1-3, see: <ul style="list-style-type: none"> Parameter 16-54 Feedback 1 [Unit]. Parameter 16-55 Feedback 2 [Unit]. Parameter 16-56 Feedback 3 [Unit]. in the feedback manager. See parameter group 20-0* Feedback. The value is limited by settings in parameter 3-02 Minimum Reference and parameter 3-03 Maximum Reference. Units as set in parameter 20-12 Reference/ Feedback Unit.

16-53 Digi Pot Reference		
Range:	Function:	
0*	[-200 - 200]	View the contribution of the digital potentiometer to the actual reference.

16-54 Feedback 1 [Unit]		
Range:	Function:	
0 ProcessCtrlUnit*	[-999999.999 - 999999.999 ProcessCtrlUnit]	View value of feedback 1, see parameter group 20-0* Feedback.

16-55 Feedback 2 [Unit]		
Range:	Function:	
0 ProcessCtrlUnit*	[-999999.999 - 999999.999 ProcessCtrlUnit]	View value of feedback 2, see parameter group 20-0* Feedback. The unit is set in parameter 20-12 Reference/ Feedback Unit.

16-56 Feedback 3 [Unit]		
Range:	Function:	
0 ProcessCtrlUnit*	[-999999.999 - 999999.999 ProcessCtrlUnit]	View value of feedback 3, see parameter group 20-0* Feedback.

16-58 PID Output [%]		
Range:	Function:	
0 %*	[0 - 100 %]	This parameter returns the frequency converter closed-loop PID controller output value in percent.

16-59 Adjusted Setpoint		
Range:	Function:	
0 ProcessCtrlUnit*	[-999999.999 - 999999.999 ProcessCtrlUnit]	Shows the value of the adjusted setpoint.

3.15.5 16-6* Inputs and Outputs

16-60 Digital Input		
Range:	Function:	
0 N/A*	[0 - 1023 N/A]	View the signal states from the active digital inputs. For example, input 18 corresponds to bit 5. 0=No signal, 1=connected signal.
	Bit 0	Digital input terminal 33.
	Bit 1	Digital input terminal 32.
	Bit 2	Digital input terminal 29.
	Bit 3	Digital input terminal 27.
	Bit 4	Digital input terminal 19.
	Bit 5	Digital input terminal 18.
	Bit 6	Digital input terminal 37.
	Bit 7	Digital input GP I/O terminal X30/4.
	Bit 8	Digital input GP I/O terminal X30/3.
	Bit 9	Digital input GP I/O terminal X30/2.
	Bits 10-63	Reserved for future terminals.
Table 3.26 Digital Input Bits		

16-61 Terminal 53 Switch Setting		
Option:	Function:	
		View the setting of input terminal 53.
[0] *	Current	
[1]	Voltage	

16-62 Analog Input 53		
Range:	Function:	
0*	[-20 - 20]	View the actual value at input 53.

16-63 Terminal 54 Switch Setting		
View the setting of input terminal 54.		
Option:	Function:	
[0] *	Current	
[1]	Voltage	

16-64 Analog Input 54		
Range:	Function:	
0*	[-20 - 20]	View the actual value at input 54.

16-65 Analog Output 42 [mA]		
Range:	Function:	
0*	[0 - 30]	View the actual value at output 42 in mA. The value shown reflects the selection in <i>parameter 6-50 Terminal 42 Output</i> .

16-66 Digital Output [bin]		
Range:	Function:	
0*	[0 - 15]	View the binary value of all digital outputs.

16-67 Freq. Input #29 [Hz]		
Range:	Function:	
0 N/A*	[0 - 130000 N/A]	View the actual frequency rate on terminal 29.

16-68 Freq. Input #33 [Hz]		
Range:	Function:	
0 N/A*	[0 - 130000 N/A]	View the actual frequency rate on terminal 33.

16-69 Pulse Output #27 [Hz]		
Range:	Function:	
0 N/A*	[0 - 40000 N/A]	View the actual value on terminal 27 in digital output mode.

16-70 Pulse Output #29 [Hz]		
Range:	Function:	
0 N/A*	[0 - 40000 N/A]	View the actual value of pulses on terminal 29 in digital output mode.

16-71 Relay Output [bin]		
Range:	Function:	
0*	[0 - 65535]	View the settings of all relays.

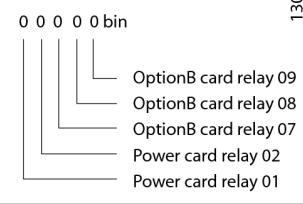
16-71 Relay Output [bin]		
Range:	Function:	
	Readout choice (Par. 16-71): Relay output (bin): 0 0 0 0 0 bin 	
	Figure 3.59 Relay Settings	

16-72 Counter A		
Range:	Function:	
0*	[-2147483648 - 2147483647]	View the present value of counter A. Counters are useful as comparator operands, see <i>parameter 13-10 Comparator Operand</i> . Reset or change the value either via digital inputs (<i>parameter group 5-1* Digital Inputs</i>) or by using an SLC action (<i>parameter 13-52 SL Controller Action</i>).

16-73 Counter B		
Range:	Function:	
0*	[-2147483648 - 2147483647]	View the present value of counter B. Counters are useful as comparator operands, <i>parameter 13-10 Comparator Operand</i> . Reset or change the value either via digital inputs (<i>parameter group 5-1* Digital Inputs</i>) or by using an SLC action (<i>parameter 13-52 SL Controller Action</i>).

16-75 Analog In X30/11		
Range:	Function:	
0*	[-20 - 20]	View the actual value at input X30/11 of VLT® General Purpose I/O MCB 101.

16-76 Analog In X30/12		
Range:	Function:	
0*	[-20 - 20]	View the actual value at input X30/12 of VLT® General Purpose I/O MCB 101.

16-77 Analog Out X30/8 [mA]		
Range:	Function:	
0*	[0 - 30]	View the actual value at input X30/8 in mA.

16-78 Analog Out X45/1 [mA]		
Range:		Function:
0.000 N/A*	[0.000 - 30.000 N/A]	Shows the actual output value at terminal X45/1. The value shown reflects the selection in <i>parameter 6-70 Terminal X45/1 Output</i> .

16-79 Analog Out X45/3 [mA]		
Range:		Function:
0.000 N/A*	[0.000 - 30.000 N/A]	Shows the actual output value at terminal X45/3. The value shown reflects the selection in <i>parameter 6-80 Terminal X45/3 Output</i> .

16-86 FC Port REF 1		
Range:		Function:
0*	[-200 - 200]	View the 2-byte status word (STW) sent to the fieldbus master. Interpretation of the status word depends on the fieldbus option installed and the control word profile selected in <i>parameter 8-10 Control Profile</i> .

16-89 Configurable Alarm/Warning Word		
Range:		Function:
0*	[0 - 65535]	Shows the alarm/warning word that is configured in <i>parameter 8-17 Configurable Alarm and Warningword</i> .

3.15.6 16-8* Fieldbus & FC Port

Parameters for reporting the bus references and control words.

16-80 Fieldbus CTW 1		
Range:		Function:
0*	[0 - 65535]	View the 2-byte control word (CTW) received from the fieldbus master. Interpretation of the control word depends on the fieldbus option installed and the control word profile selected in <i>parameter 8-10 Control Profile</i> . For more information, refer to the relevant fieldbus manual.

16-82 Fieldbus REF 1		
Range:		Function:
0*	[-200 - 200]	View the 2-byte word sent with the control word from the fieldbus master to set the reference value. For more information, refer to the relevant fieldbus manual.

16-84 Comm. Option STW		
Range:		Function:
0*	[0 - 65535]	Show the status word of the extended fieldbus communication option. For more information, refer to the relevant fieldbus manual.

16-85 FC Port CTW 1		
Range:		Function:
0*	[0 - 65535]	View the 2-byte control word (CTW) received from the fieldbus master. Interpretation of the control word depends on the fieldbus option installed and the control word profile selected in <i>parameter 8-10 Control Profile</i> .

3.15.7 16-9* Diagnosis Readouts

NOTICE!

When using MCT 10 Set-up Software, the readout parameters can only be read online, that is as the actual status. This means that the status is not stored in the MCT 10 Set-up Software file.

16-90 Alarm Word		
Range:		Function:
0*	[0 - 4294967295]	Show the alarm word sent via the serial communication port in hex code.

16-91 Alarm Word 2		
Range:		Function:
0*	[0 - 4294967295]	View the alarm word 2 sent via the serial communication port in hex code.

16-92 Warning Word		
Range:		Function:
0*	[0 - 4294967295]	Show the warning word sent via the serial communication port in hex code.

16-93 Warning Word 2		
Range:		Function:
0*	[0 - 4294967295]	View the warning word 2 sent via the serial communication port in hex code.

16-94 Ext. Status Word		
Range:		Function:
0*	[0 - 4294967295]	Returns the extended status word sent via the serial communication port in hex code.

16-95 Ext. Status Word 2		
Range:	Function:	
0* [0 - 4294967295]	Returns the extended warning word 2 sent via the serial communication port in hex code.	

16-96 Maintenance Word		
Range:	Function:	
0* [0 - 4294967295]	Readout of the preventive maintenance word. The bits reflect the status for the programmed preventive maintenance events in <i>parameter group 23-1* Maintenance</i> . 13 bits show combinations of all the possible items: <ul style="list-style-type: none"> • Bit 0: Motor bearings. • Bit 1: Pump bearings. • Bit 2: Fan bearings. • Bit 3: Valve. • Bit 4: Pressure transmitter. • Bit 5: Flow transmitter. • Bit 6: Temperature transmitter. • Bit 7: Pump seals. • Bit 8: Fan belt. • Bit 9: Filter. • Bit 10: Frequency converter cooling fan. • Bit 11: Frequency converter system health check. • Bit 12: Warranty. • Bit 13: Maintenance Text 0. • Bit 14: Maintenance Text 1. • Bit 15: Maintenance Text 2. • Bit 16: Maintenance Text 3. • Bit 17: Maintenance Text 4. • Bit 25: Service log full. 	

16-96 Maintenance Word					
Range:	Function:				
	Position 4⇒	Valve	Fan bearings	Pump bearings	Motor bearings
	Position 3⇒	Pump seals	Temperature transmitter	Flow transmitter	Pressure transmitter
	Position 2⇒	Drive system health check	Drive cooling fan	Filter	Fan belt
	Position 1⇒	-	-	-	Warranty
	0 _{hex}	-	-	-	-
	1 _{hex}	-	-	-	+
	2 _{hex}	-	-	+	-
	3 _{hex}	-	-	+	+
	4 _{hex}	-	+	-	-
	5 _{hex}	-	+	-	+
	6 _{hex}	-	+	+	-
	7 _{hex}	-	+	+	+
	8 _{hex}	+	-	-	-
	9 _{hex}	+	-	-	+
	A _{hex}	+	-	+	-
	B _{hex}	+	-	+	+
	C _{hex}	+	+	-	-
	D _{hex}	+	+	-	+
	E _{hex}	+	+	+	-
	F _{hex}	+	+	+	+

Table 3.27 Maintenance Word

Example:
The preventive maintenance word shows 040A_{hex}.

Position	1	2	3	4
Hex value	0	4	0	A

Table 3.28 Example

The 1st digit 0 indicates that no items from the 4th row require maintenance.
The 2nd digit 4 refers to the 3rd row indicating that the frequency converter cooling fan requires maintenance.
The 3rd digit 0 indicates that no items from the 2nd row require maintenance.
The 4th digit A refers to the top row indicating that the valve and the pump bearings require maintenance.

3.16 Parameters 18-** Data Readouts 2

3.16.1 18-0* Maintenance Log

This group contains the last 10 preventive maintenance events. Maintenance log 0 is the latest and maintenance log 9 the oldest.

By selecting 1 of the logs and pressing [OK], the maintenance item, action, and time of the occurrence are shown in *parameter 18-00 Maintenance Log: Item* – *parameter 18-03 Maintenance Log: Date and Time*.

The alarm log key allows access to both alarm log and maintenance log.

18-00 Maintenance Log: Item		
Array [10] Shows the fault code. For information about the fault code, see the <i>design guide</i> .		
Range:	Function:	
0*	[0 - 255]	Find the meaning of the maintenance item in <i>parameter 23-10 Maintenance Item</i> .

18-01 Maintenance Log: Action		
Array [10] Shows the fault code. For information about the fault code, see the <i>design guide</i> .		
Range:	Function:	
0*	[0 - 255]	Find the meaning of the maintenance action in <i>parameter 23-11 Maintenance Action</i> .

18-02 Maintenance Log: Time		
Array [10]		
Range:	Function:	
0 s*	[0 - 2147483647 s]	Shows when the logged event occurred. Time is measured in s since last power-up.

18-03 Maintenance Log: Date and Time		
Array [10]		
Range:	Function:	
Size related*	[0 - 0]	Shows when the logged event occurred. NOTICE! This requires that the date and time is programmed in <i>parameter 0-70 Date and Time</i> . Date format depends on the setting in <i>parameter 0-71 Date Format</i> , while the time format depends on the setting in <i>parameter 0-72 Time Format</i> .

18-03 Maintenance Log: Date and Time		
Array [10]		
Range:	Function:	
		NOTICE! The frequency converter has no back-up of the clock function. The set date/time resets to default (2000-01-01 00:00) after a power-down unless a real-time clock module with back-up is installed. In <i>parameter 0-79 Clock Fault</i> , it is possible to program a warning in case the clock has not been set properly, for example after a power-down. Incorrect setting of the clock affects the time stamps for the maintenance events.

NOTICE!

When mounting a VLT® Analog I/O MCB 109 option card, a battery back-up of date and time is included.

3.16.2 18-1* Emergency Mode Log

The log covers the latest 10 faults which have been suppressed by the emergency mode function. See parameter group *24-0* Emergency Mode*. The log can be viewed either via the following parameters or by pressing [Alarm Log] on the LCP and selecting *Emergency mode log*. It is not possible to reset the emergency mode log.

18-10 Emergency Mode Log:Event		
Range:	Function:	
0*	[0 - 255]	This parameter contains an array with 10 elements. The number read represents a fault code, which corresponds to a specific alarm. This can be found in the <i>chapter Troubleshooting</i> in the <i>design guide</i> .

18-11 Emergency Mode Log: Time		
Range:	Function:	
0 s*	[0 - 2147483647 s]	This parameter contains an array with 10 elements. The parameter shows when the logged event occurred. Time is measured in seconds since the first start of the motor.

18-12 Emergency Mode Log: Date and Time		
Range:	Function:	
Size related* [0 - 0]	This parameter contains an array with 10 elements. The parameter shows at which date and time the logged event occurred. The function relies on the fact that the actual date and time has been set in <i>parameter 0-70 Date and Time</i> . Note: There is no built-in battery back-up of the clock. Use an external back-up, for example the one in the VLT® Analog I/O MCB 109 Analog I/O option card. See <i>parameter group 0-7* Clock Settings</i> .	

3.16.3 18-3* Analog Readouts

18-30 Analog Input X42/1		
Range:	Function:	
0* [-20 - 20]	Readout of the value of the signal applied to terminal X42/1 on the VLT® analog I/O card MCB 109. The units of the value shown in the LCP correspond to the mode selected in <i>parameter 26-00 Terminal X42/1 Mode</i> .	

18-31 Analog Input X42/3		
Range:	Function:	
0* [-20 - 20]	Readout of the value of the signal applied to terminal X42/3 on the VLT® analog I/O card MCB 109. The units of the value shown in the LCP correspond to the mode selected in <i>parameter 26-01 Terminal X42/3 Mode</i> .	

18-32 Analog Input X42/5		
Range:	Function:	
0* [-20 - 20]	Readout of the value of the signal applied to terminal X42/5 on the VLT® analog I/O card MCB 109. The units of the value shown in the LCP correspond to the mode selected in <i>parameter 26-02 Terminal X42/5 Mode</i> .	

18-33 Analog Out X42/7 [V]		
Range:	Function:	
0* [0 - 30]	Readout of the value of the signal applied to terminal X42/7 on the VLT® analog I/O card MCB 109. The value shown reflects the selection in <i>parameter 26-40 Terminal X42/7 Output</i> .	

18-34 Analog Out X42/9 [V]		
Range:	Function:	
0* [0 - 30]	Readout of the value of the signal applied to terminal X42/9 on the VLT® analog I/O card MCB 109. The value shown reflects the selection in <i>parameter 26-50 Terminal X42/9 Output</i> .	

18-35 Analog Out X42/11 [V]		
Range:	Function:	
0* [0 - 30]	Readout of the value of the signal applied to terminal X42/11 on the VLT® analog I/O card MCB 109. The value shown reflects the selection in <i>parameter 26-60 Terminal X42/11 Output</i> .	

18-36 Analog Input X48/2 [mA]		
Range:	Function:	
0* [-20 - 20]	View the actual current measured at input X48/2 (VLT® Sensor Input Card MCB 114).	

18-37 Temp. Input X48/4		
Range:	Function:	
0* [-500 - 500]	View the actual temperature measured at input X48/4 (VLT® Sensor Input Card MCB 114). The temperature unit is based on the selection in <i>parameter 35-00 Term. X48/4 Temperature Unit</i> .	

18-38 Temp. Input X48/7		
Range:	Function:	
0* [-500 - 500]	View the actual temperature measured at input X48/7 (VLT® Sensor Input Card MCB 114). The temperature unit is based on the selection in <i>parameter 35-02 Term. X48/7 Temperature Unit</i> .	

18-39 Temp. Input X48/10		
Range:	Function:	
0* [-500 - 500]	View the actual temperature measured at input X48/10 (VLT® Sensor Input Card MCB 114). The temperature unit is based on the selection in <i>parameter 35-04 Term. X48/10 Temperature Unit</i> .	

18-50 Sensorless Readout [unit]		
Range:	Function:	
0 SensorlessUnit*	[-999999.999 - 999999.999 SensorlessUnit]	

3.16.4 18-6* Inputs & Outputs 2

18-60 Digital Input 2		
	Range:	Function:
0*	[0 - 65535]	View the signal states from the active digital inputs on the VLT® Advanced Cascade Controller MCO 102: Counting from right to left the positions in the binary are: DI7...DI1 ⇒ pos. 2 ...pos. 8.

3

3.17 Parameters 20-** FC Closed Loop

Closed-loop PID

This parameter group is used for configuring the closed-loop PID controller that controls the output frequency of the frequency converter.

Closed-loop DRC

DRC (Disturbance Rejection Control) improves adherence to the desired process control setpoint (for example, desired water pressure) by responding more rapidly to both incidental load disturbances and changes in setpoint. DRC reacts rapidly to ensure the system quickly returns to the desired pressurization. This improved regulation ensures process consistency and reduces oscillations that may adversely affect mechanical infrastructure. DRC relies on a proprietary control algorithm that compensates for any behavior observed as deviating from the expected behavior based on the basic physical model generated by DRC Identify. DRC Control thus intrinsically depends on the system characteristics measured by *parameter 20-79 Autotuning*, when it is set to *SPC*. The DRC controller is then engaged based on the measured system information retrieved during the auto-tuning process. DRC responsiveness is initially set to a value that depends on

whether the relevant system is defined as "normal" (default) or "fast", which can be modified in *parameter 20-71 Controller Performance*. A fast system might be a well-defined irrigation system with short ramp times that requires rapid response to changes in desired water pressure or opened valves.

NOTICE!

DRC is not yet recommended for usage in systems that utilize Cascade Controller functionality (for example, municipal water distribution systems).

3.17.1 20-0* Feedback

This parameter group is used to configure the feedback signal for the closed-loop PID controller. Whether the frequency converter is in closed-loop mode or open-loop mode, the feedback signals can be shown on the LCP display. It can also be used to control a frequency converter analog output, and be transmitted over various serial communication protocols.

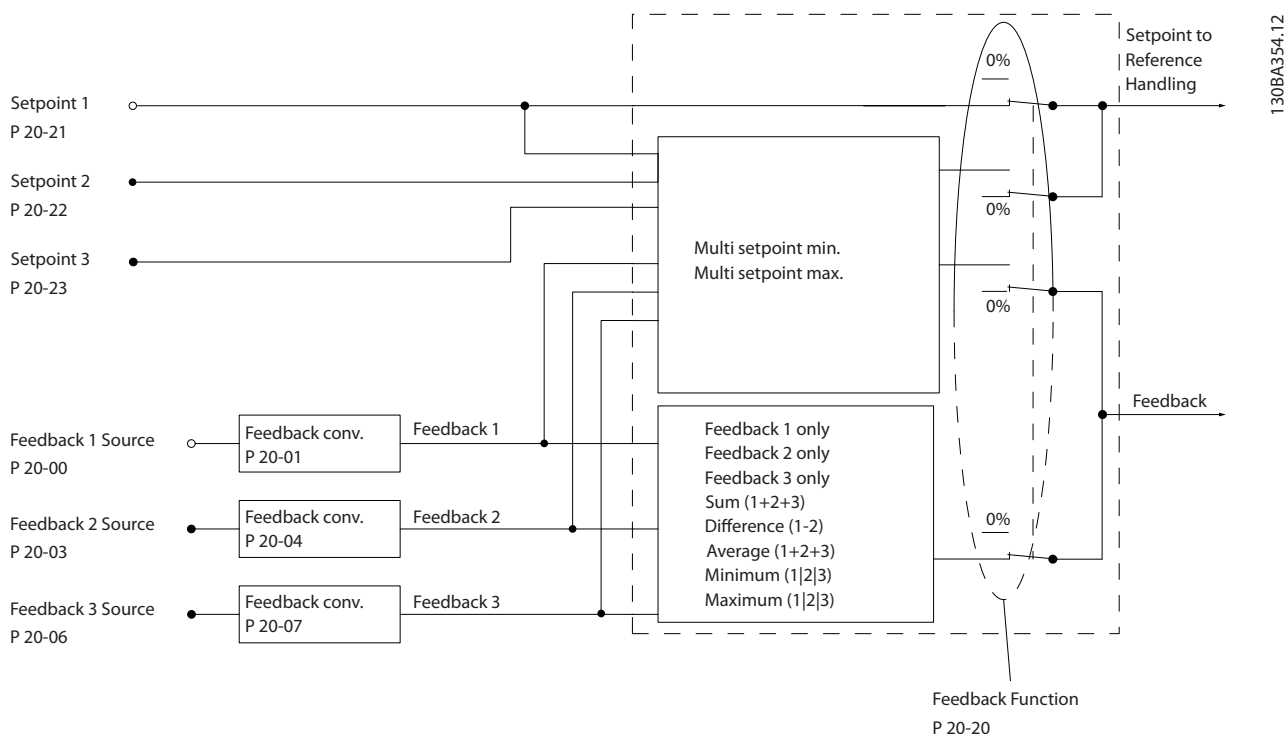

Figure 3.60 Input Signals in Closed-loop PID Controller

20-00 Feedback 1 Source		
Option:	Function:	
		<p>NOTICE!</p> <p>If feedback is not used, set its source to [0] No Function. Parameter 20-20 Feedback Function determines how the PID controller uses the 3 possible feedbacks.</p> <p>Up to 3 different feedback signals can be used to provide the feedback signal for the frequency converter's PID controller.</p> <p>This parameter defines which input is used as the source of the first feedback signal.</p> <p>Analog input X30/11 and analog input X30/12 refer to inputs on VLT® General Purpose I/O MCB 101.</p>
[0]	No function	
[1]	Analog Input 53	
[2] *	Analog Input 54	
[3]	Pulse input 29	
[4]	Pulse input 33	
[7]	Analog Input X30/11	
[8]	Analog Input X30/12	
[9]	Analog Input X42/1	
[10]	Analog Input X42/3	
[11]	Analog Input X42/5	
[15]	Analog Input X48/2	
[99]	Normal Feedback	
[100]	Bus Feedback 1	
[101]	Bus Feedback 2	
[102]	Bus feedback 3	
[104]	Sensorless Flow	Requires set-up by MCT 10 Set-up Software with sensorless plug-in.
[105]	Sensorless Pressure	Requires set-up by MCT 10 Set-up Software with sensorless plug-in.
[200]	Ext. Closed Loop 1	
[201]	Ext. Closed Loop 2	
[202]	Ext. Closed Loop 3	

20-01 Feedback 1 Conversion		
<p>This parameter allows a conversion function to be applied to feedback 1.</p> <p>[0] Linear has no effect on the feedback.</p> <p>[1] Square root is commonly used when a pressure sensor is used to provide flow feedback ($(\text{flow} \propto \sqrt{\text{pressure}})$).</p>		
Option:	Function:	
[0] *	Linear	
[1]	Square root	

20-02 Feedback 1 Source Unit		
Option:	Function:	
		<p>NOTICE!</p> <p>This parameter is only available when using pressure to temperature feedback conversion.</p> <p>If option [0] Linear is selected in parameter 20-01 Feedback 1 Conversion, the setting of any option in parameter 20-02 Feedback 1 Source Unit does not matter as a conversion is 1-to-1.</p> <p>This parameter determines the unit that is used for this feedback source, before applying the feedback conversion of parameter 20-01 Feedback 1 Conversion. This unit is not used by the PID controller.</p>
[0]		
[1]	%	
[5]	PPM	
[10]	1/min	
[11]	RPM	
[12]	Pulse/s	
[20]	l/s	
[21]	l/min	
[22]	l/h	
[23]	m ³ /s	
[24]	m ³ /min	
[25]	m ³ /h	
[30]	kg/s	
[31]	kg/min	
[32]	kg/h	
[33]	t/min	
[34]	t/h	
[40]	m/s	
[41]	m/min	
[45]	m	
[60]	°C	
[70]	mbar	
[71]	bar	
[72]	Pa	
[73]	kPa	

20-02 Feedback 1 Source Unit		
Option:	Function:	
[74]	m WG	
[75]	mm Hg	
[80]	kW	
[120]	GPM	
[121]	gal/s	
[122]	gal/min	
[123]	gal/h	
[124]	CFM	
[125]	ft ³ /s	
[126]	ft ³ /min	
[127]	ft ³ /h	
[130]	lb/s	
[131]	lb/min	
[132]	lb/h	
[140]	ft/s	
[141]	ft/min	
[145]	ft	
[160]	°F	
[170]	psi	
[171]	lb/in ²	
[172]	in WG	
[173]	ft WG	
[174]	in Hg	
[180]	HP	

20-03 Feedback 2 Source		
Option:	Function:	
		See parameter 20-00 Feedback 1 Source for details.
[0] *	No function	
[1]	Analog Input 53	
[2]	Analog Input 54	
[3]	Pulse input 29	
[4]	Pulse input 33	
[7]	Analog Input X30/11	
[8]	Analog Input X30/12	
[9]	Analog Input X42/1	
[10]	Analog Input X42/3	
[11]	Analog Input X42/5	
[15]	Analog Input X48/2	
[99]	Normal Feedback	
[100]	Bus Feedback 1	
[101]	Bus Feedback 2	
[102]	Bus feedback 3	
[104]	Sensorless Flow	
[105]	Sensorless Pressure	
[200]	Ext. Closed Loop 1	
[201]	Ext. Closed Loop 2	
[202]	Ext. Closed Loop 3	

20-04 Feedback 2 Conversion		
Option:	Function:	
		See parameter 20-01 Feedback 1 Conversion for details.
[0] *	Linear	
[1]	Square root	

20-05 Feedback 2 Source Unit		
See parameter 20-02 Feedback 1 Source Unit for details.		
Option:	Function:	
[0] *	Linear	

20-06 Feedback 3 Source		
Option:	Function:	
		See parameter 20-00 Feedback 1 Source for details.
[0] *	No function	
[1]	Analog Input 53	
[2]	Analog Input 54	
[3]	Pulse input 29	
[4]	Pulse input 33	
[7]	Analog Input X30/11	
[8]	Analog Input X30/12	
[9]	Analog Input X42/1	
[10]	Analog Input X42/3	
[11]	Analog Input X42/5	
[15]	Analog Input X48/2	
[99]	Normal Feedback	
[100]	Bus Feedback 1	
[101]	Bus Feedback 2	
[102]	Bus feedback 3	
[104]	Sensorless Flow	
[105]	Sensorless Pressure	
[200]	Ext. Closed Loop 1	
[201]	Ext. Closed Loop 2	
[202]	Ext. Closed Loop 3	

20-07 Feedback 3 Conversion		
Option:	Function:	
		See parameter 20-01 Feedback 1 Conversion for details.
[0] *	Linear	
[1]	Square root	

20-08 Feedback 3 Source Unit		
See parameter 20-02 Feedback 1 Source Unit for details.		
Option:	Function:	
[0]		
[1]	%	
[5]	PPM	
[10]	1/min	

20-08 Feedback 3 Source Unit		
See <i>parameter 20-02 Feedback 1 Source Unit</i> for details.		
Option:	Function:	
[11]	RPM	
[12]	Pulse/s	
[20]	l/s	
[21]	l/min	
[22]	l/h	
[23]	m ³ /s	
[24]	m ³ /min	
[25]	m ³ /h	
[30]	kg/s	
[31]	kg/min	
[32]	kg/h	
[33]	t/min	
[34]	t/h	
[40]	m/s	
[41]	m/min	
[45]	m	
[60]	°C	
[70]	mbar	
[71]	bar	
[72]	Pa	
[73]	kPa	
[74]	m WG	
[75]	mm Hg	
[80]	kW	
[120]	GPM	
[121]	gal/s	
[122]	gal/min	
[123]	gal/h	
[124]	CFM	
[125]	ft ³ /s	
[126]	ft ³ /min	
[127]	ft ³ /h	
[130]	lb/s	
[131]	lb/min	
[132]	lb/h	
[140]	ft/s	
[141]	ft/min	
[145]	ft	
[160]	°F	
[170]	psi	
[171]	lb/in ²	
[172]	in WG	
[173]	ft WG	
[174]	in Hg	
[180]	HP	

20-12 Reference/Feedback Unit		
This parameter determines the unit that is used for the setpoint reference and feedback that the PID controller uses for controlling the output frequency of the frequency converter.		
Option:	Function:	
[0]		
[1]	%	
[5]	PPM	
[10]	l/min	
[11]	RPM	
[12]	Pulse/s	
[20]	l/s	
[21]	l/min	
[22]	l/h	
[23]	m ³ /s	
[24]	m ³ /min	
[25]	m ³ /h	
[30]	kg/s	
[31]	kg/min	
[32]	kg/h	
[33]	t/min	
[34]	t/h	
[40]	m/s	
[41]	m/min	
[45]	m	
[60]	°C	
[70]	mbar	
[71]	bar	
[72]	Pa	
[73]	kPa	
[74]	m WG	
[75]	mm Hg	
[80]	kW	
[120]	GPM	
[121]	gal/s	
[122]	gal/min	
[123]	gal/h	
[124]	CFM	
[125]	ft ³ /s	
[126]	ft ³ /min	
[127]	ft ³ /h	
[130]	lb/s	
[131]	lb/min	
[132]	lb/h	
[140]	ft/s	
[141]	ft/min	
[145]	ft	
[160]	°F	
[170]	psi	
[171]	lb/in ²	
[172]	in WG	

3
20-12 Reference/Feedback Unit

This parameter determines the unit that is used for the setpoint reference and feedback that the PID controller uses for controlling the output frequency of the frequency converter.

Option:
Function:

[173]	ft WG	
[174]	in Hg	
[180]	HP	

3.17.2 20-2* Feedback/Setpoint

This parameter group is used to determine how the PID controller uses the 3 possible feedback signals to control the output frequency of the frequency converter. This group is also used to store the 3 internal setpoint references.

Parameter 20-20 Feedback Function

This parameter determines how the 3 possible feedbacks are used to control the output frequency of the frequency converter.

NOTICE!

Any unused feedback must be set to [0] No function in its feedback source parameter 20-00 Feedback 1 Source, parameter 20-03 Feedback 2 Source, or parameter 20-06 Feedback 3 Source.

The feedback resulting from the function selected in parameter 20-20 Feedback Function is used by the PID controller to control the output frequency of the frequency converter. This feedback can also be shown on the frequency converter display, be used to control an analog

output, and be transmitted over various serial communication protocols.

The frequency converter can be configured to handle multi-zone applications. 2 different multi-zone applications are supported:

- Multi-zone, single setpoint.
- Multi-zone, multi-setpoint.

The difference between the 2 is illustrated by the following examples:

Example 1 – multi-zone, single setpoint

In an office building, a VAV (variable air volume) water system must ensure a minimum pressure at selected VAV boxes. Due to the varying pressure losses in each duct, the pressure at each VAV box cannot be assumed to be the same. The minimum pressure required is the same for all VAV boxes. Select option [3] Minimum in parameter 20-20 Feedback Function to set up this control method. Enter the pressure in parameter 20-21 Setpoint 1. The PID controller increases the speed of the fan if any feedback is below the setpoint and decreases the speed of the fan if all feedbacks are above the setpoint.

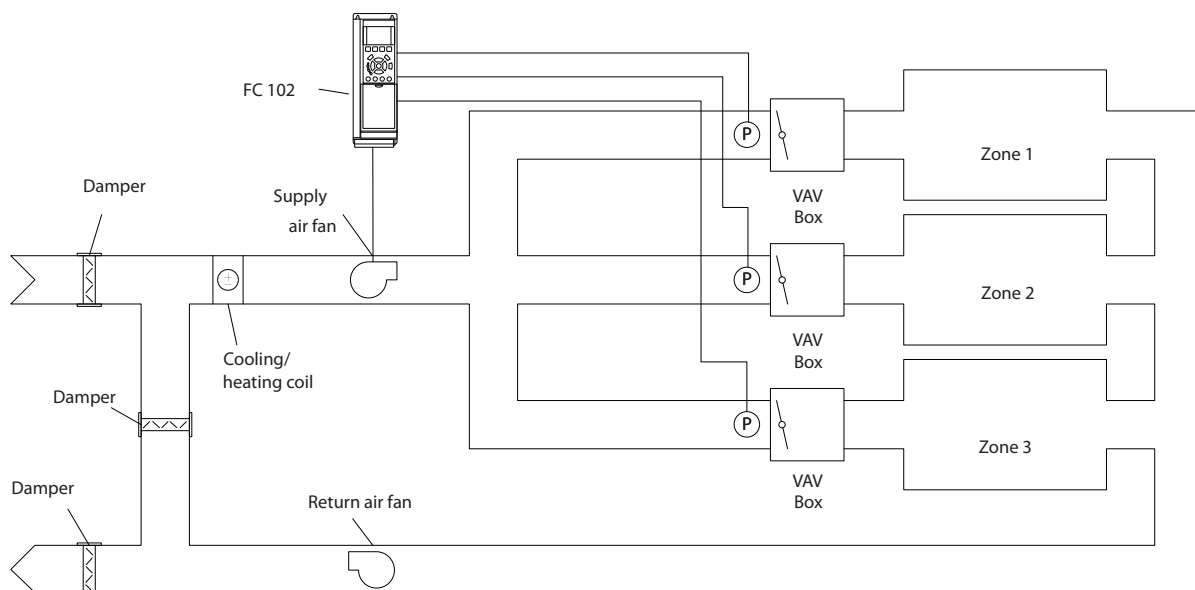

130BA353.10

Figure 3.61 Multi-zone Application Scheme

Example 2 – multi-zone, multi-setpoint

The previous example illustrates the use of multi-zone, multi-setpoint control. If the zones require different pressures for each VAV box, each setpoint may be specified in parameter 20-21 Setpoint 1, parameter 20-22 Setpoint 2, and parameter 20-23 Setpoint 3. By selecting [5] Multi setpoint minimum in parameter 20-20 Feedback Function, the PID controller increases the fan speed if any feedback value is below its setpoint. If all feedbacks are above their

individual setpoints, the PID controller decreases the fan speed.

20-20 Feedback Function		
Option:	Function:	
[0]	Sum	Sets up the PID controller to use the sum of feedback 1, feedback 2, and feedback 3 as the feedback.

20-20 Feedback Function		
Option:	Function:	
		The sum of setpoint 1 and any other references that are enabled (see <i>parameter group 3-1* References</i>) are used as the setpoint reference of the PID controller.
[1]	Difference	Sets up the PID controller to use the difference between feedback 1 and feedback 2 as the feedback. Feedback 3 is not used with this selection. Only setpoint 1 is used. The sum of setpoint 1 and any other references that are enabled (see <i>parameter group 3-1* References</i>) are used as the setpoint reference of the PID controller.
[2]	Average	Sets up the PID controller to use the average of feedback 1, feedback 2, and feedback 3 as the feedback.
[3]	Minimum	Sets up the PID controller to compare feedback 1, feedback 2, and feedback 3, and use the lowest value as the feedback. Only setpoint 1 is used. The sum of setpoint 1 and any other references that are enabled (see <i>parameter group 3-1* References</i>) are used as the setpoint reference of the PID controller.
[4]	Maximum *	Sets up the PID controller to compare feedback 1, feedback 2, and feedback 3, and use the highest value as the feedback. Only setpoint 1 is used. The sum of setpoint 1 and any other references that are enabled (see <i>parameter group 3-1* References</i>) are used as the setpoint reference of the PID controller.
[5]	Multi Setpoint Min	Sets up the PID controller to calculate the difference between feedback 1 and setpoint 1, feedback 2 and setpoint 2, and feedback 3 and setpoint 3. It uses the feedback/setpoint pair in which the feedback is the farthest below its corresponding setpoint reference. If all feedback signals are above their corresponding setpoints, the PID controller uses the feedback/setpoint pair in which the difference between the feedback and setpoint is the least.

20-20 Feedback Function		
Option:	Function:	
		<p>NOTICE!</p> <p>If only 2 feedback signals are used, the feedback that is not to be used must be set to [0] No Function in <i>parameter 20-00 Feedback 1 Source</i>, <i>parameter 20-03 Feedback 2 Source</i>, or <i>parameter 20-06 Feedback 3 Source</i>. Each setpoint reference is the sum of its respective parameter value and any other references that are enabled (see <i>parameter group 3-1* References</i>).</p>
[6]	Multi Setpoint Max	<p>Sets up the PID controller to calculate the difference between feedback 1 and setpoint 1, feedback 2 and setpoint 2, and feedback 3 and setpoint 3. It uses the feedback/setpoint pair in which the feedback is farthest above its corresponding setpoint reference. If all feedback signals are below their corresponding setpoints, the PID controller uses the feedback/setpoint pair in which the difference between the feedback and the setpoint reference is the least.</p> <p>NOTICE!</p> <p>If only 2 feedback signals are used, the feedback that is not to be used must be set to [0] No Function in <i>parameter 20-00 Feedback 1 Source</i>, <i>parameter 20-03 Feedback 2 Source</i>, or <i>parameter 20-06 Feedback 3 Source</i>. Each setpoint reference is the sum of its respective parameter value (<i>parameter 20-21 Setpoint 1</i>, <i>parameter 20-22 Setpoint 2</i>, and <i>parameter 20-23 Setpoint 3</i>) and any other references that are enabled (see <i>parameter group 3-1* References</i>).</p>

20-21 Setpoint 1		
Range:		Function:
0 ProcessCtrlUnit*	[-999999.999 - 999999.999 ProcessCtrlUnit]	Setpoint 1 is used in closed-loop mode to enter a setpoint reference that is used by the frequency converter's PID controller. See the description of <i>parameter 20-20 Feedback Function</i> . NOTICE! The setpoint reference entered here is added to any other references that are enabled (see <i>parameter group 3-1* References</i>).

20-22 Setpoint 2		
Range:		Function:
0 ProcessCtrlUnit*	[-999999.999 - 999999.999 ProcessCtrlUnit]	Setpoint 2 is used in closed-loop mode to enter a setpoint reference for the PID controller. See the description of <i>parameter 20-20 Feedback Function</i> . NOTICE! The setpoint reference entered here is added to any other references that are enabled (see <i>parameter group 3-1* References</i>).

20-23 Setpoint 3		
Range:		Function:
0 ProcessCtrlUnit*	[-999999.999 - 999999.999 ProcessCtrlUnit]	Setpoint 3 is used in closed-loop mode to enter a setpoint reference for the PID controller. See the description of <i>parameter 20-20 Feedback Function</i> . NOTICE! If the minimum and maximum references are altered, a new PID auto-tuning may be needed.

20-23 Setpoint 3		
Range:		Function:
		NOTICE! The setpoint reference entered here is added to any other references that are enabled (see <i>parameter group 3-1* References</i>).

20-60 Sensorless Unit		
Option:		Function:
[20]	l/s	
[23]	m ³ /s	
[24]	m ³ /min	
[25]	m ³ /h	
[71]	bar	
[73]	kPa	
[74]	m WG	
[75]	mm Hg	
[120]	GPM	
[121]	gal/s	
[122]	gal/min	
[123]	gal/h	
[124]	CFM	
[125]	ft ³ /s	
[126]	ft ³ /min	
[170]	psi	
[171]	lb/in ²	
[172]	in WG	
[173]	ft WG	
[174]	in Hg	

20-69 Sensorless Information		
Array [8]		
Range:		Function:
0*	[0 - 25]	

3.17.3 20-7* Auto-tuning

PID Auto-tuning

The frequency converter closed-loop controller (*parameter group 20-** FC Closed Loop*) can be auto-tuned, simplifying and saving time during commissioning, while ensuring accurate control adjustment. To use auto-tuning, configure the frequency converter for closed loop in *parameter 1-00 Configuration Mode*.

Use a graphical local control panel (GLCP) to react to messages during the auto-tuning sequence.

Selecting either *PID* or *SPC* in *parameter 20-79 Autotuning* puts the frequency converter into auto-tuning mode. The LCP then shows on-screen instructions.

To start the fan/pump, press [Auto On] and apply a start signal. The default control settings ensure that the setpoint it eventually reached. For PID auto-tuning, it is possible to adjust the speed manually by pressing [▲] or [▼] to a level where the feedback is around the system setpoint.

CAUTION
 If the feedback goes outside the specified limits (2073 and 2074) defined during auto-tune set-up, the auto-tuning is discarded. The limits also serve as application protection during auto-tuning execution.

NOTICE!
 It is not possible to run the motor at maximum or minimum speed when manually adjusting the motor speed due to the need of increasing the motor speed during auto-tuning.

Auto-tuning introduces step changes while operating at a steady state and then monitors the feedback. For PID control, the auto-tuning feedback response defines the required values for *parameter 20-93 PID Proportional Gain* and *parameter 20-94 PID Integral Time* are calculated. *Parameter 20-95 PID Differentiation Time* is set to value 0 (zero). *Parameter 20-81 PID Normal/ Inverse Control* is determined during the tuning process.

These calculated values are presented in the LCP and can be either accepted or rejected. Once accepted, the values are written to the relevant parameters and auto-tuning mode is disabled in *parameter 20-79 Autotuning*. Depending on the system, the time required to carry out auto-tuning could be several minutes.

Before carrying out the auto-tuning, set the following parameters according to the load inertia:

- *Parameter 3-41 Ramp 1 Ramp Up Time.*
- *Parameter 3-42 Ramp 1 Ramp Down Time.*

Or

- *Parameter 3-51 Ramp 2 Ramp Up Time.*
- *Parameter 3-52 Ramp 2 Ramp Down Time.*

If PID auto-tuning is carried out with slow ramp times, the auto-tuned parameters typically result in slow control. Before activating PID auto-tuning, remove excessive feedback sensor noise using the input filter (*parameter groups 6-** Analog In/Out, 5-5* Pulse Input* and *26-** Analog I/O Option MCB 109, parameter 6-16 Terminal 53 Filter Time Constant, parameter 6-26 Terminal 54 Filter Time Constant, parameter 5-54 Pulse Filter Time Constant #29, parameter 5-59 Pulse Filter Time Constant #33*). To obtain the most accurate controller parameters, carry out PID auto-tuning when the application runs in typical operation, that is with a typical load.

SPC Auto-tuning

SPC initiates a tuning of DRC. If feedback from the system determines the system to be 2nd order, auto-tuning proceeds automatically with tuning of PID parameters. If SPC discards the DRC, it is shown by the process bar going to step 4.

DRC assumes that the frequency converter's target applications can be generically modeled as 1st order plus dead-time systems. DRC auto-tuning is providing the feedback for calculation.

- τ = time constant of process system K_p process system gain.
- θ = time delay between input and output DRC can only be set up by using SPC.

20-70 Closed Loop Type		
Option:	Function:	
		Select the application response speed if it is known. The default setting is sufficient for most applications. A more precise value decreases the time needed for carrying out PID adaptation. The setting has no impact on values of parameters and only affects the auto-tuning speed.
[0] *	Auto	Takes 30–120 s to complete.
[1]	Fast Pressure	Takes 10–60 s to complete.
[2]	Slow Pressure	Takes 30–120 s to complete.
[3]	Fast Temperature	Takes 10–20 minutes to complete.
[4]	Slow Temperature	Takes 30–60 minutes to complete.

20-71 Controller Performance		
Option:	Function:	
[0] *	Normal	Normal setting of this parameter is suitable for pressure control in fan systems.
[1]	Fast	Fast setting is used in pumping systems, where a faster control response is wanted.

20-72 Output Change		
Range:		Function:
0.10*	[0.01 - 0.50]	This parameter sets the magnitude of step change during auto-tuning. The value is a percentage of full speed. That is, if maximum output frequency in <i>parameter 4-13 Motor Speed High Limit [RPM]</i> / <i>parameter 4-14 Motor Speed High Limit [Hz]</i> is set to 50 Hz, 0.10 is 10% of 50 Hz, which is 5 Hz. Set this parameter to a value resulting in feedback changes of 10–20% for best tuning accuracy.

20-73 Minimum Feedback Level		
Range:		Function:
-999999 ProcessCtrlUnit*	[-999999.999 - par. 20-74 ProcessCtrlUnit]	Enter the minimum allowable feedback level in user units as defined in <i>parameter 20-12 Reference/ Feedback Unit</i> . If the level drops below <i>parameter 20-73 Minimum Feedback Level</i> , auto-tuning is aborted and an error message appears in the LCP.

20-74 Maximum Feedback Level		
Range:		Function:
999999 ProcessCtrlUnit*	[par. 20-73 - 999999.999 ProcessCtrlUnit]	Enter the maximum allowable feedback level in user units as defined in <i>parameter 20-12 Reference/ Feedback Unit</i> . If the level rises above <i>parameter 20-74 Maximum Feedback Level</i> , auto-tuning is aborted and an error message appears in the LCP.

20-79 Autotuning		
Option:		Function:
		This parameter starts the auto-tuning sequence. Once the auto-tuning has successfully completed and the settings have been accepted or rejected by pressing [OK] or [Cancel] at the end of tuning, this parameter is reset to [0] Disabled.
[0] *	Disabled	
[1]	PID	Enables PID auto-tuning.
[2]	Smart Process	Enables smart process control auto-tuning. That automatically selects the best suitable controller principle (PID or DRC).

20-79 Autotuning		
Option:		Function:
[3]	DRC	This option is activated by SPC auto-tuning. Not typically used as a manual option.

3.17.4 20-8* PID Basic Settings

This parameter group is used to configure the basic operation of the PID controller, including:

- Response to feedback above or below the setpoint.
- The speed at which it first starts functioning.
- When it indicates that the system has reached the setpoint.

20-81 PID Normal/ Inverse Control		
Option:		Function:
[0] *	Normal	The frequency converter's output frequency decreases when the feedback is greater than the setpoint reference. This behavior is common for pressure-controlled supply fan and pump applications.
[1]	Inverse	The frequency converter's output frequency increases when the feedback is greater than the setpoint reference.

20-82 PID Start Speed [RPM]		
Range:		Function:
Size related*	[0 - par. 4-13 RPM]	<p>NOTICE!</p> <p>This parameter is only visible if <i>parameter 0-02 Motor Speed Unit</i> is set to [0] RPM.</p> <p>When the frequency converter is first started, it initially ramps up to this output speed in open-loop mode, following the active ramp-up time. When the output speed programmed is reached, the frequency converter automatically switches to closed-loop mode and the PID controller begins to function. This is useful in applications that require quick acceleration to a minimum speed at start-up.</p>

20-83 PID Start Speed [Hz]	
Range:	Function:
Size related* [0 - 4-14 Hz]	<p>NOTICE!</p> <p>This parameter is only visible if parameter 0-02 Motor Speed Unit is set to [1] Hz.</p> <p>When the frequency converter is first started, it initially ramps up to this output frequency in open-loop mode, following the active ramp-up time. When the output frequency programmed is reached, the frequency converter automatically switches to closed-loop mode and the PID controller begins to function. This is useful in applications that require quick acceleration to a minimum speed at start-up.</p>

20-84 On Reference Bandwidth	
Range:	Function:
5 %* [0 - 200 %]	<p>When the difference between the feedback and the setpoint reference is less than the value of this parameter, the frequency converter's display shows <i>Run on Reference</i>. This status can be communicated externally by programming the function of a digital output for [8] <i>Run on Reference/No Warning</i>. Also, for serial communications, the <i>On Reference</i> status bit of the frequency converter status word is high (value = 1).</p> <p>The <i>On Reference Bandwidth</i> is calculated as a percentage of the setpoint reference.</p>

3.17.5 20-9* PID Controller

Use these parameters to adjust the PID controller manually. By adjusting the PID controller parameters, the control performance may be improved. See the *VLT® AQUA Drive FC 202 Design Guide* for guidelines on adjusting the PID controller parameters.

20-91 PID Anti Windup		
Option:	Function:	
	<p>NOTICE!</p> <p>Option [1] On is activated automatically, if 1 of the following options is selected in parameters in parameter group 21-**. Ext. Closed Loop: [0] Normal, [X] Enabled Ext CLX PID.</p>	
[0]	Off	The integrator continues to change value also after output has reached 1 of the extremes. This can afterwards cause a delay of change of the output of the controller.
[1] *	On	The integrator is locked if the output of the built-in PID controller has reached 1 of the extremes (minimum or maximum value) and therefore is not able to add further changes to the value of the process parameter controlled. This allows the controller to respond more quickly when it can control the system again.

20-93 PID Proportional Gain		
Range:	Function:	
2*	[0 - 10]	The proportional gain indicates the number of times the error between the setpoint and the feedback signal is to be applied.

If (Error x Gain) jumps with a value equal to what is set in parameter 3-03 *Maximum Reference*, the PID controller tries to change the output speed equal to what is set in parameter 4-13 *Motor Speed High Limit [RPM]*/parameter 4-14 *Motor Speed High Limit [Hz]*. However, in practice it is limited by this setting. The proportional band (error causing output to change from 0–100%) can be calculated with the formula:

$$\left(\frac{1}{\text{Proportional Gain}} \right) \times (\text{Max Reference})$$

NOTICE!

Set the value for parameter 3-03 *Maximum Reference* before setting the values for the PID controller in parameter group 20-9* *PID Controller*.

20-94 PID Integral Time		
Range:	Function:	
8 s* [0.01 - 10000 s]	<p>The integrator accumulates a contribution to the output from the PID controller as long as there is a deviation between the reference/setpoint and feedback signals. The contribution is proportional to the size of the deviation. This ensures that the deviation (error) approaches zero. Quick response on any deviation is obtained when the integral time is set to a low value. Setting it too low, however, may cause the control to become unstable.</p> <p>The value set is the time needed for the integrator to add the same contribution as the proportional for a certain deviation.</p> <p>If the value is set to 10000, the controller acts as a pure proportional controller with a P-band based on the value set in <i>parameter 20-93 PID Proportional Gain</i>. When no deviation is present, the output from the proportional controller is 0.</p>	

20-95 PID Differentiation Time		
Range:	Function:	
0 s* [0 - 10 s]	<p>The differentiator monitors the rate of change of the feedback. If the feedback is changing quickly, it adjusts the output of the PID controller to reduce the rate of change of the feedback. Quick PID controller response is obtained when this value is large. However, if too large of a value is used, the frequency converter's output frequency may become unstable.</p> <p>Differentiation time is useful in situations where extremely fast frequency converter response and precise speed control are required. It can be difficult to adjust this for proper system control. Differentiation time is not commonly used in water/wastewater applications. Therefore, it is best to leave this parameter at 0 or OFF.</p>	

20-96 PID Diff. Gain Limit		
Range:	Function:	
5* [1 - 50]	<p>The differential function of a PID controller responds to the rate of change of the feedback. As a result, an abrupt change in the feedback can cause the differential function to make a large change in the PID controller output. This parameter limits the maximum effect that the PID controller differential function can produce. A smaller value reduces the maximum effect of the PID controller differential function.</p> <p>This parameter is only active when <i>parameter 20-95 PID Differentiation Time</i> is not set to OFF (0 s).</p>	

3.18 Parameters 21-** Extended Closed Loop

The FC 202 offers 3 extended closed-loop PID controllers in addition to the PID controller. These controllers can be configured independently to control either external actuators (valves, dampers, and so on) or be used together with the internal PID controller to improve the dynamic responses to setpoint changes or load disturbances.

The extended closed-loop PID controllers may be interconnected or connected to the PID closed-loop controller to form a dual loop configuration.

To control a modulating device (for example, a valve motor), this device must be a positioning servo motor with built-in electronics accepting either a 0–10 V (signal from VLT® Analog I/O Option MCB 109) or a 0/4–20 mA control signal.

The output function can be programmed in the following parameters:

- Control card, terminal 42: *Parameter 6-50 Terminal 42 Output* (options [113]...[115] or [149]...[151], Ext. Closed Loop 1/2/3).
- VLT® General purpose I/O card MCB 101, terminal X30/8: *Parameter 6-60 Terminal X30/8 Output*, (setting [113]...[115] or [149]...[151], Ext. Closed Loop 1/2/3).
- VLT® Analog I/O Option MCB 109, terminal X42/7...11: *Parameter 26-40 Terminal X42/7 Output*, *parameter 26-50 Terminal X42/9 Output*, *parameter 26-60 Terminal X42/11 Output* (options [113]...[115], Ext. Closed Loop 1/2/3).

VLT® General purpose I/O card MCB 109 and VLT® analog I/O option MCB 109 are optional.

3.18.1 21-0* Extended CL Autotuning

The extended closed-loop PID controllers can each be auto-tuned, simplifying and saving time during commissioning, while ensuring accurate PID control adjustment.

To use PID auto-tuning, configure the relevant extended PID controller for the application.

Use a graphical LCP to react on messages during the auto-tuning sequence.

Enabling auto-tuning, *parameter 21-09 PID Auto Tuning* puts the relevant PID controller into PID auto-tuning mode. The LCP then provides on-screen instructions.

PID auto-tuning introduces step changes and then monitors the feedback. Based on the feedback response, the following required values are calculated:

- PID proportional gain.
 - *Parameter 21-21 Ext. 1 Proportional Gain* for EXT CL 1.
 - *Parameter 21-41 Ext. 2 Proportional Gain* for EXT CL 2.
 - *Parameter 21-61 Ext. 3 Proportional Gain* for EXT CL 3.
- Integral time.
 - *Parameter 21-22 Ext. 1 Integral Time* for EXT CL 1.
 - *Parameter 21-42 Ext. 2 Integral Time* for EXT CL 2.
 - *Parameter 21-62 Ext. 3 Integral Time* for EXT CL 3.

The PID differentiation time is set to 0 in the following parameters:

- *Parameter 21-23 Ext. 1 Differentiation Time* for EXT CL 1.
- *Parameter 21-43 Ext. 2 Differentiation Time* for EXT CL 2.
- *Parameter 21-63 Ext. 3 Differentiation Time* for EXT CL 3 are set to value 0 (zero).
- *Parameter 21-20 Ext. 1 Normal/Inverse Control* for EXT CL 1.
- *Parameter 21-40 Ext. 2 Normal/Inverse Control* for EXT CL 2.
- *Parameter 21-60 Ext. 3 Normal/Inverse Control* for EXT CL 3.

These calculated values are presented on the LCP and can either be accepted or rejected. Once accepted, the values are written to the relevant parameters, and PID auto-tuning mode is disabled in *parameter 21-09 PID Auto Tuning*. Depending on the system being controlled, the time required to carry out PID auto-tuning could be several minutes.

Before activating the PID auto-tuning, remove excessive feedback sensor noise using the input filter (parameter groups 5-5* *Pulse Input*, 6-** *Analog In/Out* and 26-** *Analog I/O Option MCB 109*, terminal 53/54 filter time constant, and pulse filter time constant #29/33).

21-00 Closed Loop Type		
Option:	Function:	
		This parameter defines the application response. The default mode should be sufficient for most applications. If the relative application speed is known, it can be selected here. This decreases the time needed for carrying out PID auto-tuning. The setting has no impact on the value of the tuned parameters and is used only for the PID auto-tuning sequence.
[0] *	Auto	
[1]	Fast Pressure	
[2]	Slow Pressure	
[3]	Fast Temperature	
[4]	Slow Temperature	

21-01 PID Performance		
Option:	Function:	
[0] *	Normal	Normal setting of this parameter is suitable for pressure control in fan systems.
[1]	Fast	Fast setting would generally be used in pumping systems, where a faster control response is desirable.

21-02 PID Output Change		
Range:	Function:	
0.10*	[0.01 - 0.50]	This parameter sets the magnitude of step change during auto tuning. The value is a percentage of full operating range. That is, if the maximum analog output voltage is set to 10 V, 0.10 is 10% of 10 V, which is 1 V. Set this parameter to a value resulting in feedback changes of 10–20% for best tuning accuracy.

21-03 Minimum Feedback Level		
Range:	Function:	
-999999*	[-999999.999 - par. 21-04]	Enter the minimum allowable feedback level in user units as defined in: <ul style="list-style-type: none"> Parameter 21-10 Ext. 1 Ref./ Feedback Unit for EXT CL 1. Parameter 21-30 Ext. 2 Ref./ Feedback Unit for EXT CL 2. Parameter 20-05 Feedback 2 Source Unit for EXT CL 3. <p>If the level drops below parameter 21-03 Minimum Feedback Level, PID auto-tuning is aborted, and</p>

21-03 Minimum Feedback Level		
Range:	Function:	
		an error message appears in the display.

21-04 Maximum Feedback Level		
Range:	Function:	
999999*	[par. 21-03 - 999999.999]	Enter the maximum allowable feedback level in user units as defined in: <ul style="list-style-type: none"> Parameter 21-10 Ext. 1 Ref./ Feedback Unit for EXT CL 1. Parameter 21-30 Ext. 2 Ref./ Feedback Unit for EXT CL 2. Parameter 20-05 Feedback 2 Source Unit for EXT CL 3. <p>If the level rises above parameter 21-04 Maximum Feedback Level, PID auto tuning is aborted, and an error message appears in the display.</p>

21-09 PID Auto Tuning		
Option:	Function:	
		This parameter enables selection of the extended PID controller to be auto-tuned and starts the PID auto-tuning for that controller. Once the auto-tuning has successfully completed and the settings have been accepted or rejected by pressing [OK] or [Cancel] at the end of tuning, this parameter is reset to [0] Disabled.
[0] *	Disabled	
[1]	Enabled Ext CL1 PID	
[2]	Enabled Ext CL 2 PID	
[3]	Enabled Ext CL 3 PID	

3.18.2 21-1* Closed Loop 1 Ref/Feedback

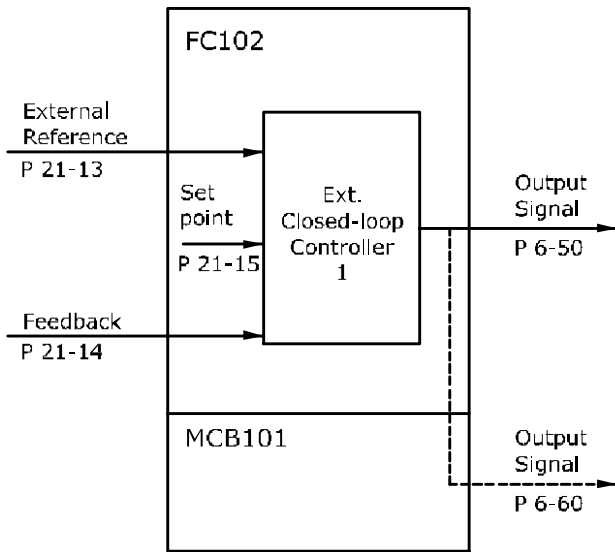

130BA355.11

Figure 3.62 Closed Loop 1 Ref/Feedback

21-10 Ext. 1 Ref./Feedback Unit	
Option:	Function:
	Select the unit for the reference and feedback.
[0] *	
[1]	%
[5]	PPM
[10]	1/min
[11]	RPM
[12]	Pulse/s
[20]	l/s
[21]	l/min
[22]	l/h
[23]	m ³ /s
[24]	m ³ /min
[25]	m ³ /h
[30]	kg/s
[31]	kg/min
[32]	kg/h
[33]	t/min
[34]	t/h
[40]	m/s
[41]	m/min
[45]	m
[60]	°C
[70]	mbar
[71]	bar
[72]	Pa
[73]	kPa

21-10 Ext. 1 Ref./Feedback Unit	
Option:	Function:
[74]	m WG
[75]	mm Hg
[80]	kW
[120]	GPM
[121]	gal/s
[122]	gal/min
[123]	gal/h
[124]	CFM
[125]	ft ³ /s
[126]	ft ³ /min
[127]	ft ³ /h
[130]	lb/s
[131]	lb/min
[132]	lb/h
[140]	ft/s
[141]	ft/min
[145]	ft
[160]	°F
[170]	psi
[171]	lb/in ²
[172]	in WG
[173]	ft WG
[174]	in Hg
[180]	HP

21-11 Ext. 1 Minimum Reference	
Range:	Function:
0 ExtPID1Unit* [-999999.999 - par. 21-12 ExtPID1Unit]	Select the minimum reference for the closed-loop 1 controller.

21-12 Ext. 1 Maximum Reference	
Range:	Function:
100 ExtPID1Unit* [par. 21-11 - 999999.999 ExtPID1Unit]	<p>NOTICE!</p> <p>Set the value for <i>parameter 21-12 Ext. 1 Maximum Reference</i> before setting the values for the PID controller in <i>parameter group 20-9* PID Controller</i>.</p> <p>Select the maximum reference for the closed-loop 1 controller.</p> <p>The dynamics of the PID controller depend on the value set in this parameter. See also <i>parameter 21-21 Ext. 1 Proportional Gain</i>.</p>

21-13 Ext. 1 Reference Source		
Option:	Function:	
		This parameter defines which input on the frequency converter should be treated as the source of the reference signal for the closed-loop 1 controller. Analog input X30/11 and analog input X30/12 refer to inputs on the VLT® General Purpose I/O Card MCB 101.
[0] *	No function	
[1]	Analog Input 53	
[2]	Analog Input 54	
[7]	Pulse input 29	
[8]	Pulse input 33	
[20]	Digital pot.meter	
[21]	Analog input X30/11	
[22]	Analog input X30/12	
[23]	Analog Input X42/1	
[24]	Analog Input X42/3	
[25]	Analog Input X42/5	
[29]	Analog Input X48/2	
[30]	Ext. Closed Loop 1	
[31]	Ext. Closed Loop 2	
[32]	Ext. Closed Loop 3	
[33]	PCD Bus Reference	
[35]	Digital input select	

21-14 Ext. 1 Feedback Source		
Option:	Function:	
		This parameter defines which input on the frequency converter should be treated as the source of the feedback signal for the closed-loop 1 controller. Analog input X30/11 and analog input X30/12 refer to inputs on the VLT® General Purpose I/O Card MCB 101.
[0] *	No function	
[1]	Analog Input 53	
[2]	Analog Input 54	
[3]	Pulse input 29	
[4]	Pulse input 33	
[7]	Analog Input X30/11	
[8]	Analog Input X30/12	
[9]	Analog Input X42/1	
[10]	Analog Input X42/3	
[11]	Analog Input X42/5	
[15]	Analog Input X48/2	
[99]	Normal Feedback	
[100]	Bus Feedback 1	
[101]	Bus Feedback 2	

21-14 Ext. 1 Feedback Source		
Option:	Function:	
[102]	Bus feedback 3	
[104]	Sensorless Flow	
[105]	Sensorless Pressure	
[200]	Ext. Closed Loop 1	
[201]	Ext. Closed Loop 2	
[202]	Ext. Closed Loop 3	

21-15 Ext. 1 Setpoint		
Range:	Function:	
0 ExtPID1Unit*	[-999999.999 - 999999.999 ExtPID1Unit]	The setpoint reference is used in extended 1 closed loop. Ext.1 Setpoint is added to the value from the Ext.1 Reference Source selected in <i>parameter 21-13 Ext. 1 Reference Source</i> .

21-17 Ext. 1 Reference [Unit]		
Range:	Function:	
0 ExtPID1Unit*	[-999999.999 - 999999.999 ExtPID1Unit]	Readout of the reference value for the closed-loop 1 controller.

21-18 Ext. 1 Feedback [Unit]		
Range:	Function:	
0 ExtPID1Unit*	[-999999.999 - 999999.999 ExtPID1Unit]	Readout of the feedback value for the closed-loop 1 controller.

21-19 Ext. 1 Output [%]		
Range:	Function:	
0 %*	[0 - 100 %]	Readout of the output value for the closed-loop 1 controller.

3.18.3 21-2* Closed Loop 1 PID

21-20 Ext. 1 Normal/Inverse Control		
Option:	Function:	
[0] *	Normal	Reduces the output when feedback is higher than the reference.
[1]	Inverse	Increase the output when feedback is higher than the reference.

21-21 Ext. 1 Proportional Gain		
Range:	Function:	
0.50*	[0 - 10]	The proportional gain contains the factor indicating the number of times the error between the setpoint and the feedback signal is to be applied.

If the product error times gain jumps with a value equal to what is set in *parameter 3-03 Maximum Reference*, the PID controller tries to change the output speed equal to what is set in *parameter 4-13 Motor Speed High Limit [RPM]*/*parameter 4-14 Motor Speed High Limit [Hz]*. However, in practice, it is limited by this setting.

The proportional band (error causing output to change from 0–100%) can be calculated with the formula:

$$\left(\frac{1}{\text{Proportional Gain}} \right) \times (\text{Max Reference})$$

NOTICE!

Set the value for *parameter 3-03 Maximum Reference* before setting the values for the PID controller in *parameter group 20-9* PID Controller*.

21-22 Ext. 1 Integral Time		
Range:	Function:	
20 s* [0.01 - 10000 s]	Over time, the integrator accumulates a contribution to the output from the PID controller as long as there is a deviation between the reference/setpoint and feedback signals. The contribution is proportional to the size of the deviation. This ensures that the deviation (error) approaches 0. Quick response on any deviation is obtained when the integral time is set to a low value. Setting it too low, however, may cause the control to become unstable. The value set is the time needed for the integrator to add the same contribution as the proportional for a certain deviation. If the value is set to 10000, the controller acts as a pure proportional controller with a P-band based on the value set in <i>parameter 20-93 PID Proportional Gain</i> . When no deviation is present, the output from the proportional controller is 0.	

21-23 Ext. 1 Differentiation Time		
Range:	Function:	
0 s* [0 - 10 s]	The differentiator does not react to a constant error. It only provides a gain when the feedback changes. The quicker the feedback changes, the stronger the gain from the differentiator.	

21-24 Ext. 1 Dif. Gain Limit		
Range:	Function:	
5* [1 - 50]	Set a limit for the differentiator gain (DG). The DG increases if there are fast changes. Limit the DG to obtain a pure differentiator gain when changes	

21-24 Ext. 1 Dif. Gain Limit		
Range:	Function:	
	are slow and a constant differentiator gain when quick changes occur.	

21-26 Ext. 1 On Reference Bandwidth		
Range:	Function:	
5 %* [0 - 200 %]	Enter the on-reference bandwidth. When the PID control error (the difference between the reference and the feedback) is less than the value of this parameter, the on-reference status bit is high.	

3.18.4 21-3* Closed Loop 2 Ref/Fb

21-30 Ext. 2 Ref./Feedback Unit		
Option:	Function:	
	See <i>parameter 21-10 Ext. 1 Ref./Feedback Unit</i> for details.	
[0] *		
[1]	%	
[5]	PPM	
[10]	1/min	
[11]	RPM	
[12]	Pulse/s	
[20]	l/s	
[21]	l/min	
[22]	l/h	
[23]	m ³ /s	
[24]	m ³ /min	
[25]	m ³ /h	
[30]	kg/s	
[31]	kg/min	
[32]	kg/h	
[33]	t/min	
[34]	t/h	
[40]	m/s	
[41]	m/min	
[45]	m	
[60]	°C	
[70]	mbar	
[71]	bar	
[72]	Pa	
[73]	kPa	
[74]	m WG	
[75]	mm Hg	
[80]	kW	
[120]	GPM	
[121]	gal/s	
[122]	gal/min	

21-30 Ext. 2 Ref./Feedback Unit		
Option:	Function:	
[123]	gal/h	
[124]	CFM	
[125]	ft ³ /s	
[126]	ft ³ /min	
[127]	ft ³ /h	
[130]	lb/s	
[131]	lb/min	
[132]	lb/h	
[140]	ft/s	
[141]	ft/min	
[145]	ft	
[160]	°F	
[170]	psi	
[171]	lb/in ²	
[172]	in WG	
[173]	ft WG	
[174]	in Hg	
[180]	HP	

21-31 Ext. 2 Minimum Reference		
Range:	Function:	
0 ExtPID2Unit*	[-999999.999 - par. 21-32 ExtPID2Unit]	See parameter 21-11 Ext. 1 Minimum Reference for details.

21-32 Ext. 2 Maximum Reference		
Range:	Function:	
100 ExtPID2Unit*	[par. 21-31 - 999999.999 ExtPID2Unit]	See parameter 21-12 Ext. 1 Maximum Reference for details.

21-33 Ext. 2 Reference Source		
Option:	Function:	
		See parameter 21-13 Ext. 1 Reference Source for details.
[0] *	No function	
[1]	Analog Input 53	
[2]	Analog Input 54	
[7]	Pulse input 29	
[8]	Pulse input 33	
[20]	Digital pot.meter	
[21]	Analog input X30/11	
[22]	Analog input X30/12	
[23]	Analog Input X42/1	
[24]	Analog Input X42/3	
[25]	Analog Input X42/5	
[29]	Analog Input X48/2	
[30]	Ext. Closed Loop 1	
[31]	Ext. Closed Loop 2	

21-33 Ext. 2 Reference Source		
Option:	Function:	
[32]	Ext. Closed Loop 3	
[33]	PCD Bus Reference	
[35]	Digital input select	

21-34 Ext. 2 Feedback Source		
Option:	Function:	
		See parameter 21-14 Ext. 1 Feedback Source for details.
[0] *	No function	
[1]	Analog Input 53	
[2]	Analog Input 54	
[3]	Pulse input 29	
[4]	Pulse input 33	
[7]	Analog Input X30/11	
[8]	Analog Input X30/12	
[9]	Analog Input X42/1	
[10]	Analog Input X42/3	
[11]	Analog Input X42/5	
[15]	Analog Input X48/2	
[99]	Normal Feedback	
[100]	Bus Feedback 1	
[101]	Bus Feedback 2	
[102]	Bus feedback 3	
[104]	Sensorless Flow	
[105]	Sensorless Pressure	
[200]	Ext. Closed Loop 1	
[201]	Ext. Closed Loop 2	
[202]	Ext. Closed Loop 3	

21-35 Ext. 2 Setpoint		
Range:	Function:	
0 ExtPID2Unit*	[-999999.999 - 999999.999 ExtPID2Unit]	See parameter 21-15 Ext. 1 Setpoint for details.

21-37 Ext. 2 Reference [Unit]		
Range:	Function:	
0 ExtPID2Unit*	[-999999.999 - 999999.999 ExtPID2Unit]	See parameter 21-17 Ext. 1 Reference [Unit], Ext. 1 Reference [Unit], for details.

21-38 Ext. 2 Feedback [Unit]		
Range:	Function:	
0 ExtPID2Unit*	[-999999.999 - 999999.999 ExtPID2Unit]	See parameter 21-18 Ext. 1 Feedback [Unit] for details.

21-39 Ext. 2 Output [%]		
Range:		Function:
0 %*	[0 - 100 %]	See parameter 21-19 Ext. 1 Output [%] for details.

3.18.5 21-4* Closed Loop 2 PID

21-40 Ext. 2 Normal/Inverse Control		
Option:		Function:
		See parameter 21-20 Ext. 1 Normal/Inverse Control for details.
[0] *	Normal	
[1]	Inverse	

21-41 Ext. 2 Proportional Gain		
Range:		Function:
0.50*	[0 - 10]	See parameter 21-21 Ext. 1 Proportional Gain for details.

21-42 Ext. 2 Integral Time		
Range:		Function:
20 s*	[0.01 - 10000 s]	See parameter 21-22 Ext. 1 Integral Time for details.

21-43 Ext. 2 Differentiation Time		
Range:		Function:
0 s*	[0 - 10 s]	See parameter 21-23 Ext. 1 Differentiation Time for details.

21-44 Ext. 2 Dif. Gain Limit		
Range:		Function:
5*	[1 - 50]	See parameter 21-24 Ext. 1 Dif. Gain Limit for details.

21-46 Ext. 2 On Reference Bandwidth		
Range:		Function:
5 %*	[0 - 200 %]	Enter the on-reference bandwidth. When the PID control error (the difference between the reference and the feedback) is less than the value of this parameter, the on-reference status bit is high.

3.18.6 21-5* Closed Loop 3 Ref/Fb

20-05 Feedback 2 Source Unit		
See parameter 20-02 Feedback 1 Source Unit for details.		

Option:		Function:
[0] *	Linear	

21-51 Ext. 3 Minimum Reference		
Range:		Function:
0 ExtPID3Unit*	[-999999.999 - par. 21-52 ExtPID3Unit]	See parameter 21-11 Ext. 1 Minimum Reference for details.

21-52 Ext. 3 Maximum Reference		
Range:		Function:
100 ExtPID3Unit*	[par. 21-51 - 999999.999 ExtPID3Unit]	See parameter 21-12 Ext. 1 Maximum Reference for details.

21-53 Ext. 3 Reference Source		
Option:		Function:
		See parameter 21-13 Ext. 1 Reference Source for details.
[0] *	No function	
[1]	Analog Input 53	
[2]	Analog Input 54	
[7]	Pulse input 29	
[8]	Pulse input 33	
[20]	Digital pot.meter	
[21]	Analog input X30/11	
[22]	Analog input X30/12	
[23]	Analog Input X42/1	
[24]	Analog Input X42/3	
[25]	Analog Input X42/5	
[29]	Analog Input X48/2	
[30]	Ext. Closed Loop 1	
[31]	Ext. Closed Loop 2	
[32]	Ext. Closed Loop 3	
[33]	PCD Bus Reference	
[35]	Digital input select	

21-54 Ext. 3 Feedback Source		
Option:	Function:	
		See parameter 21-14 Ext. 1 Feedback Source for details.
[0] *	No function	
[1]	Analog Input 53	
[2]	Analog Input 54	
[3]	Pulse input 29	
[4]	Pulse input 33	
[7]	Analog Input X30/11	
[8]	Analog Input X30/12	
[9]	Analog Input X42/1	
[10]	Analog Input X42/3	
[11]	Analog Input X42/5	
[15]	Analog Input X48/2	
[99]	Normal Feedback	
[100]	Bus Feedback 1	
[101]	Bus Feedback 2	
[102]	Bus feedback 3	
[104]	Sensorless Flow	
[105]	Sensorless Pressure	
[200]	Ext. Closed Loop 1	
[201]	Ext. Closed Loop 2	
[202]	Ext. Closed Loop 3	

21-55 Ext. 3 Setpoint		
Range:	Function:	
0 ExtPID3Unit*	[-999999.999 - 999999.999 ExtPID3Unit]	See parameter 21-15 Ext. 1 Setpoint for details.

21-57 Ext. 3 Reference [Unit]		
Range:	Function:	
0 ExtPID3Unit*	[-999999.999 - 999999.999 ExtPID3Unit]	See parameter 21-17 Ext. 1 Reference [Unit] for details.

21-58 Ext. 3 Feedback [Unit]		
Range:	Function:	
0 ExtPID3Unit*	[-999999.999 - 999999.999 ExtPID3Unit]	See parameter 21-18 Ext. 1 Feedback [Unit] for details.

21-59 Ext. 3 Output [%]		
Range:	Function:	
0 %*	[0 - 100 %]	See parameter 21-19 Ext. 1 Output [%] for details.

3.18.7 21-6* Closed Loop 3 PID

21-60 Ext. 3 Normal/Inverse Control		
Option:	Function:	
		See parameter 21-20 Ext. 1 Normal/Inverse Control for details.
[0] *	Normal	
[1]	Inverse	

21-61 Ext. 3 Proportional Gain		
Range:	Function:	
0.50*	[0 - 10]	See parameter 21-21 Ext. 1 Proportional Gain for details.

21-62 Ext. 3 Integral Time		
Range:	Function:	
20 s*	[0.01 - 10000 s]	See parameter 21-22 Ext. 1 Integral Time for details.

21-63 Ext. 3 Differentiation Time		
Range:	Function:	
0 s*	[0 - 10 s]	See parameter 21-23 Ext. 1 Differentiation Time for details.

21-64 Ext. 3 Dif. Gain Limit		
Range:	Function:	
5*	[1 - 50]	See parameter 21-24 Ext. 1 Dif. Gain Limit for details.

21-66 Ext. 3 On Reference Bandwidth		
Range:	Function:	
5 %*	[0 - 200 %]	Enter the on-reference bandwidth. When the PID control error (the difference between the reference and the feedback) is less than the value of this parameter, the on-reference status bit is high.

3.19 Parameters 22-** Application Functions

3.19.1 22-0* Miscellaneous

This group contains parameters used for monitoring water/wastewater applications.

22-00 External Interlock Delay		
Range:	Function:	
0 s* [0 - 600 s]	Only relevant if 1 of the digital inputs in parameter group 5-1* Digital Inputs has been programmed for [7] External Interlock. The	

22-00 External Interlock Delay		
Range:	Function:	
	external interlock timer introduces a delay after the signal has been removed from the digital input programmed for external interlock, before reaction takes place.	

3.19.2 22-2* No-Flow Detection

130BA252.14

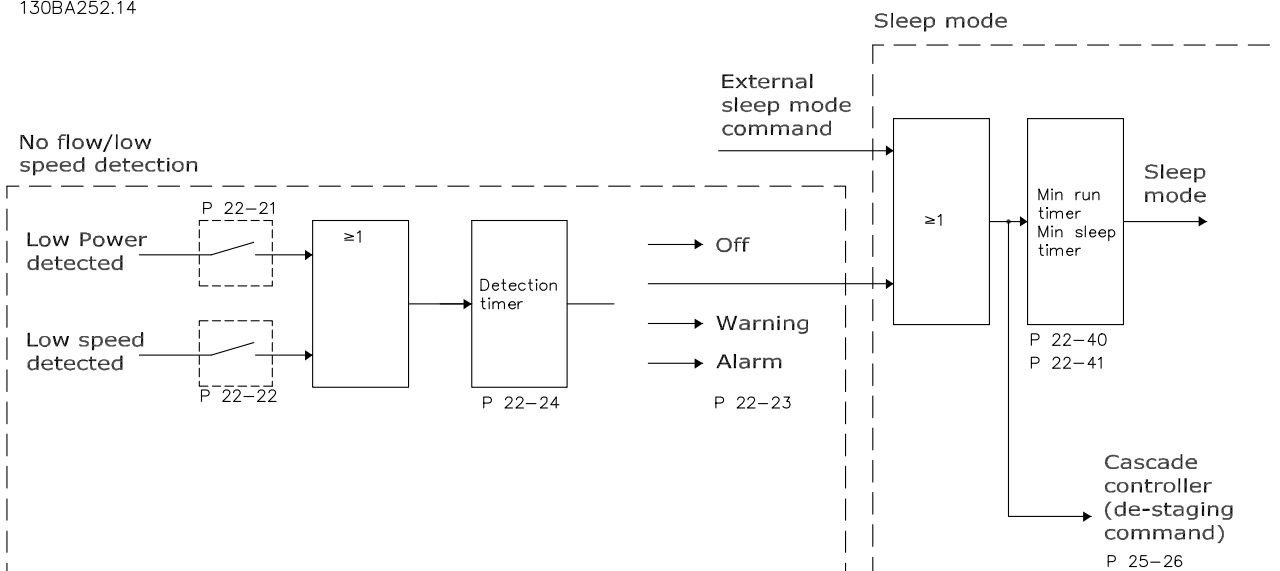

Figure 3.63 Signal Flow Chart

The VLT® AQUA Drive FC 202Parameters 25includes functions that detect if the load conditions in the system allow the motor to be stopped:

- Low-power detection.
- Low-speed detection.

1 of these 2 signals must be active for a set time (parameter 22-24 No-Flow Delay) before selected action takes place. Possible actions to select (parameter 22-23 No-Flow Function) are:

- No action.
- Warning.
- Alarm.
- Sleep mode.

No-flow detection

This function is used to detect a no-flow situation in pump systems where all valves can be closed. It can be used both when controlled by the integrated PI controller in the frequency converter or an external PI controller. Program the actual configuration in parameter 1-00 Configuration Mode.

Configuration mode for:

- Integrated PI controller: Closed loop.
- External PI controller: Open loop.

NOTICE!

Carry out no-flow tuning before setting the PI controller parameters.

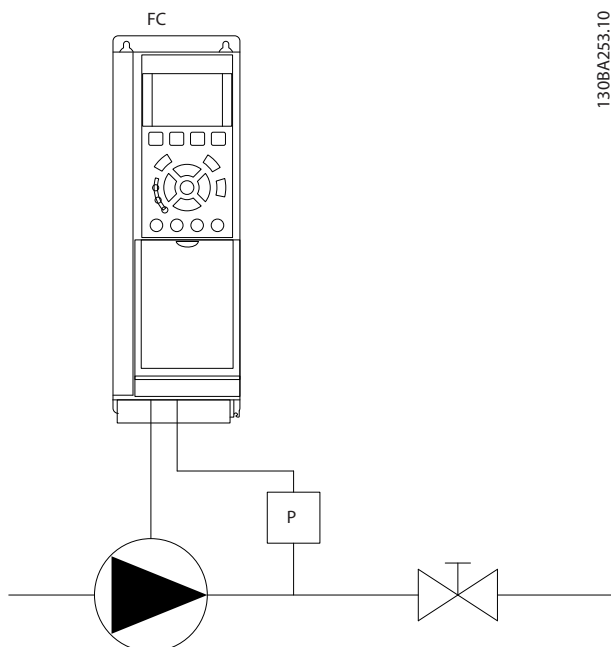

130BA253.10

Figure 3.64 No-flow Detection Scheme

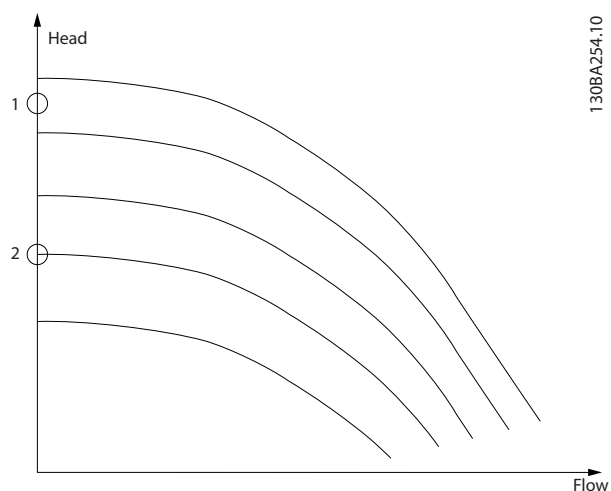

130BA254.10

Figure 3.65 No-flow Detection Graph

No-flow detection is based on the measurement of speed and power. For a certain speed, the frequency converter calculates the power at no flow. This coherence is based on the adjustment of 2 sets of speed and associated power at no flow. By monitoring the power, it is possible to detect no-flow conditions in

systems with fluctuating suction pressure, or if the pump has a flat characteristic towards low speed. Base the 2 sets of data on measurement of power at approximately 50% and 85% of maximum speed with the valve closed. The data is programmed in *parameter group 22-3* No-flow Power Tuning*. It is also possible to run a *parameter 22-20 Low Power Auto Set-up*, automatically stepping through the commissioning process, and also automatically storing the data measured. Set the frequency converter for open loop in *parameter 1-00 Configuration Mode*, when carrying out the auto set-up (see *parameter group 22-3* No-flow Power Tuning*).

NOTICE!

When using the integrated PI controller, carry out no-flow tuning before setting the PI controller parameters.

Low-speed detection

Low-speed detection gives a signal if the motor operates with minimum speed as set in *parameter 4-11 Motor Speed Low Limit [RPM]* or *parameter 4-12 Motor Speed Low Limit [Hz]*. Actions are common with no-flow detection (individual selection not possible).

The use of low-speed detection is not limited to systems with a no-flow situation. It can be used in any system where operation at minimum speed allows for a stop of the motor until the load calls for a speed higher than minimum speed. An example is systems with fans and compressors.

NOTICE!

In pump systems, ensure that the minimum speed in *parameter 4-11 Motor Speed Low Limit [RPM]* or *parameter 4-12 Motor Speed Low Limit [Hz]* has been set high enough for detection as the pump can run with a rather high speed even with valves closed.

Dry-pump detection

No-flow detection can also be used to detect if the pump has run dry (low power consumption and high speed). It can be used with both the integrated PI controller and an external PI controller.

The conditions for dry-pump signal are:

- Power consumption below no-flow level.
- Pump running at maximum speed or maximum reference open loop, whichever is lowest.

The signal must be active for a set time (*parameter 22-27 Dry Pump Delay*) before the selected action takes place.

Possible actions to select (*parameter 22-26 Dry Pump Function*) are:

- Warning.
- Alarm.

Enable the low-power detection in *parameter 22-21 Low Power Detection*. Perform the tuning using *parameter group 22-3*, No-Flow Power Tuning*.

In a dry-pump detection set-up, select [0] Off in *parameter 22-23 No-Flow Function*. Otherwise, make sure that the options in that parameter do not prevent the dry-pump detection.

22-20 Low Power Auto Set-up	
Option:	Function:
[0] *	Off
[1]	Enabled

Start of auto set-up of power data for no-flow power tuning.

NOTICE!
Do the auto set-up when the system has reached normal operating temperature.

NOTICE!
It is important that *parameter 4-13 Motor Speed High Limit [RPM]* or *parameter 4-14 Motor Speed High Limit [Hz]* is set to the maximum operational speed of the motor.
It is important to do the auto set-up before configuring the integrated PI controller as settings are reset when changing from closed loop to open loop in *parameter 1-00 Configuration Mode*.

NOTICE!
Carry out the tuning with the same settings in *parameter 1-03 Torque Characteristics* as for operation after the tuning.

An auto set-up sequence is activated, automatically setting the speed to approximately 50% and 85% of nominal motor speed (*parameter 4-13 Motor Speed High Limit [RPM]*, *parameter 4-14 Motor Speed High Limit [Hz]*). At those 2 speeds, the power consumption is automatically measured and stored.

Before enabling auto set-up:

1. Close valves to create a no-flow condition.
2. Set the frequency converter to open loop (*parameter 1-00 Configuration Mode*). It is important also to set *parameter 1-03 Torque Characteristics*.

22-21 Low Power Detection	
Option:	Function:
[0] *	Disabled

22-21 Low Power Detection	
Option:	Function:
[1]	Enabled

To set the parameters in *parameter group 22-3* No-Flow Power Tuning* for proper operation, carry out the low-power detection commissioning.

22-22 Low Speed Detection	
Option:	Function:
[0] *	Disabled
[1]	Enabled
[2]	Enabled with boost
[3]	Enabled for multiple drives
[4]	Enabled multidrive boost

Detects when the motor operates with a speed as set in *parameter 4-11 Motor Speed Low Limit [RPM]* or *parameter 4-12 Motor Speed Low Limit [Hz]*.

This option is available when [3] Closed Loop is selected in *parameter 1-00 Configuration Mode*.
Enable this option to improve the low-speed detection for applications with at least 1 of the following characteristics:

- Varying inlet pressure.
- A pressure drop at the outlet caused by closing a non-return valve.

In such applications, the frequency converter potentially does not reduce the speed to the minimum as required for the normal low speed detection.
When this option is selected, the frequency converter creates a pressure pulse (boost of the pressure) when the feedback is within the range defined in *parameter 7-39 On Reference Bandwidth* for a time period defined in *parameter 22-40 Minimum Run Time* or longer. *Parameter 22-45 Setpoint Boost* adjusts the height of the pulses. *Parameter 22-46 Maximum Boost Time* defines the maximum length of the pulse.

NOTICE!
Ensure that the system can withstand the boost pressure.

For applications with multiple frequency converters. Enable low speed detection with the following features:

- Minimum run time.
- Minimum sleep time.
- Boost.

For applications with multiple frequency converters. This option is available when [3] Closed Loop is selected in *parameter 1-00 Configuration Mode*.

22-22 Low Speed Detection	
Option:	Function:
	<p>Enable this option to improve the low-speed detection for applications with at least 1 of the following characteristics:</p> <ul style="list-style-type: none"> • Varying inlet pressure. • A pressure drop at the outlet caused by closing a non-return valve. <p>In such applications, the frequency converter potentially does not reduce the speed to the minimum as required for the normal low speed detection.</p> <p>When this option is selected, the frequency converter creates a pressure pulse (boost of the pressure) when the feedback is within the range defined in <i>parameter 7-39 On Reference Bandwidth</i> for a time period defined in <i>parameter 22-40 Minimum Run Time</i> or longer. <i>Parameter 22-45 Setpoint Boost</i> adjusts the height of the pulses.</p> <p><i>Parameter 22-46 Maximum Boost Time</i> defines the maximum length of the pulse.</p> <p>Refer to <i>Cascade Controller Options MCO 101/102 Operating Instructions</i> for more information about the cascade controller.</p> <p>NOTICE! Ensure that the system can withstand the boost pressure.</p>

22-23 No-Flow Function	
Common actions for low-power detection and low-speed detection (individual selections not possible).	
Option:	Function:
[0] * Off	<p>NOTICE! Do not set <i>parameter 14-20 Reset Mode</i>, to [13] <i>Infinite auto reset</i>, when <i>parameter 22-23 No-Flow Function</i> is set to [3] <i>Alarm</i>. Doing so causes the frequency converter to continuously cycle between running and stopping when a no-flow condition is detected.</p>

22-23 No-Flow Function	
Common actions for low-power detection and low-speed detection (individual selections not possible).	
Option:	Function:
	<p>NOTICE! Disable the automatic bypass function of the bypass if the frequency converter is equipped with a constant-speed bypass with an automatic bypass function starting the bypass if the frequency converter experiences a persistent alarm condition, and [3] <i>Alarm</i> is selected as the no-flow function.</p>
[1]	<p>Sleep Mode The frequency converter enters sleep mode and stops when a no-flow condition is detected. See <i>parameter group 22-4* Sleep Mode</i> for programming options for sleep mode.</p>
[2]	<p>Warning The frequency converter continues to run, but activates a no-flow warning (<i>warning 92, NoFlow</i>). A digital output or a serial communication bus can communicate a warning to other equipment.</p>
[3]	<p>Trip The frequency converter stops running and activates a no-flow alarm (<i>alarm 92, NoFlow</i>). A frequency converter digital output or a serial communication bus can communicate an alarm to other equipment.</p>
[4]	<p>Stop and Trip</p>

22-24 No-Flow Delay	
Range:	Function:
10 s* [1 - 600 s]	Set the time that low power/low speed must stay detected to activate signal for actions. If detection disappears before the timer runs out, the timer is reset.

22-26 Dry Pump Function	
Select the action for dry-pump operation.	
Option:	Function:
[0] * Off	

22-26 Dry Pump Function		
Select the action for dry-pump operation.		
Option:	Function:	
[1]	Warning	<p>NOTICE!</p> <p>To use dry-pump detection:</p> <ol style="list-style-type: none"> 1. Enable low-power detection in <i>parameter 22-21 Low Power Detection</i>. 2. Commission low-power detection using either <i>parameter group 22-3* No-flow Power Tuning No Flow Power Tuning</i>, or <i>parameter 22-20 Low Power Auto Set-up</i>. <p>NOTICE!</p> <p>Do not set <i>parameter 14-20 Reset Mode</i> to [13] <i>Infinite auto reset</i>, when <i>parameter 22-26 Dry Pump Function</i> is set to [2] <i>Alarm</i>. Doing so causes the frequency converter to continuously cycle between running and stopping when a dry-pump condition is detected.</p> <p>NOTICE!</p> <p>For frequency converters with constant-speed bypass.</p> <p>If an automatic bypass function starts the bypass at persistent alarm conditions, disable the automatic bypass function, if [2] <i>Alarm</i> or [3] <i>Man. Reset Alarm</i> is selected as the dry-pump function.</p> <p>The frequency converter continues to run, but activates a dry-pump warning (<i>warning 93, Dry pump</i>). A frequency converter digital output or a serial communication bus can communicate a warning to other equipment.</p>
[2]	Trip	The frequency converter stops running and activates a dry-pump alarm (<i>alarm 93, Dry pump</i>). A frequency converter digital output or a serial communication bus can communicate an alarm to other equipment.
[3]	Manual Reset Trip	The frequency converter stops running and activates a dry-pump alarm (<i>alarm 93, Dry pump</i>). A frequency converter digital output or a serial communication bus can communicate an alarm to other equipment.
[4]	Stop and Trip	

22-27 Dry Pump Delay		
Range:	Function:	
10 s*	[0 - 600 s]	Defines for how long the dry-pump condition must be active before activating a warning or an alarm. The frequency converter waits for the no-flow delay time (<i>parameter 22-24 No-Flow Delay</i>) to expire before the timer for the dry-pump delay starts.

22-28 No-Flow Low Speed [RPM]		
Range:	Function:	
Size related*	[0 - par. 4-13 RPM]	Used to set the speed for no-flow low-speed detection. If a low-speed detection at a speed different from the motor minimum speed is needed, this parameter may be used.

22-29 No-Flow Low Speed [Hz]		
Range:	Function:	
Size related*	[0 - par. 4-14 Hz]	Used to set the speed for no-flow low-speed detection. If a low-speed detection at a speed different from the motor minimum speed is needed, this parameter may be used.

3.19.3 22-3* No-flow Power Tuning

If auto set-up is disabled in *parameter 22-20 Low Power Auto Set-up*, the tuning sequence is:

NOTICE!

Set *parameter 1-03 Torque Characteristics* before tuning takes place.

1. Close the main valve to stop flow.
2. Run with motor until the system has reached normal operating temperature.
3. Press [Hand On] and adjust speed for approximately 85% of rated speed. Note the exact speed.
4. Read power consumption either by looking for actual power in the data line in the LCP or by viewing 1 of the following parameters:
 - 4a *Parameter 16-10 Power [kW]*.

Or

- 4b *Parameter 16-11 Power [hp]* in the Main Menu.

Note the power readout.

5. Change speed to approximately 50% of rated speed. Note the exact speed.
6. Read power consumption either by looking for actual power in the data line in the LCP or by viewing 1 of the following parameters:
 - 6a *Parameter 16-10 Power [kW]*.

Or

 - 6b *Parameter 16-11 Power [hp]* in the Main Menu.

Note the power readout.

7. Program the speeds used in:
 - 7a *Parameter 22-32 Low Speed [RPM]*.
 - 7b *Parameter 22-33 Low Speed [Hz]*.
 - 7c *Parameter 22-36 High Speed [RPM]*.
 - 7d *Parameter 22-37 High Speed [Hz]*.
8. Program the associated power values in:
 - 8a *Parameter 22-34 Low Speed Power [kW]*.
 - 8b *Parameter 22-35 Low Speed Power [HP]*.
 - 8c *Parameter 22-38 High Speed Power [kW]*.
 - 8d *Parameter 22-39 High Speed Power [HP]*.
9. Switch back with [Auto On] or [Off].

22-30 No-Flow Power		
Range:	Function:	
0 kW*	[0 - 0 kW]	Readout of calculated no-flow power at actual speed. If power drops to the display value, the frequency converter considers the condition as a no-flow situation.

22-31 Power Correction Factor		
Range:	Function:	
100 % *	[1 - 400 %]	Make corrections to the calculated power in <i>parameter 22-30 No-Flow Power</i> . If no-flow is detected when it should not be detected, decrease the setting. However, if no-flow is not detected when it should be detected, increase the setting to above 100%.

22-32 Low Speed [RPM]		
Range:	Function:	
Size related*	[0 - par. 22-36 RPM]	To be used if <i>parameter 0-02 Motor Speed Unit</i> is set to [0] RPM (parameter not visible if [1] Hz is selected).

22-32 Low Speed [RPM]		
Range:	Function:	
		Set used speed for the 50% level. This function is used for storing values necessary for tuning no-flow detection.

22-33 Low Speed [Hz]		
Range:	Function:	
Size related*	[0 - par. 22-37 Hz]	To be used if <i>parameter 0-02 Motor Speed Unit</i> is set for [1] Hz (parameter not visible if [0] RPM is selected). Set used speed for the 50% level. The function is used for storing values necessary for tuning no-flow detection.

22-34 Low Speed Power [kW]		
Range:	Function:	
Size related*	[0 - 5.50 kW]	To be used if <i>parameter 0-03 Regional Settings</i> is set for [0] International (parameter not visible if [1] North America is selected). Set power consumption at 50% speed level. This function is used for storing values necessary for tuning no-flow detection.

22-35 Low Speed Power [HP]		
Range:	Function:	
Size related*	[0 - 7.50 hp]	To be used if <i>parameter 0-03 Regional Settings</i> is set for [1] North America (parameter not visible if [0] International is selected). Set power consumption at 50% speed level. This function is used for storing values necessary for tuning no-flow detection.

22-36 High Speed [RPM]		
Range:	Function:	
Size related*	[0 - par. 4-13 RPM]	To be used if <i>parameter 0-02 Motor Speed Unit</i> is set for [0] RPM (parameter not visible if [1] Hz is selected). Set used speed for the 85% level. The function is used for storing values necessary for tuning no-flow detection.

22-37 High Speed [Hz]		
Range:	Function:	
Size related*	[0 - par. 4-14 Hz]	To be used if <i>parameter 0-02 Motor Speed Unit</i> is set for [1] Hz (parameter not visible if [0] RPM is selected). Set used speed for the 85% level. The function is used for storing values necessary for tuning no-flow detection.

22-38 High Speed Power [kW]		
Range:	Function:	
Size related* [0 - 5.50 kW]	To be used, if <i>parameter 0-03 Regional Settings</i> is set for [0] <i>International</i> (parameter not visible if [1] <i>North America</i> is selected). Set power consumption at 85% speed level. This function is used for storing values necessary for tuning no-flow detection.	

22-39 High Speed Power [HP]		
Range:	Function:	
Size related* [0 - 7.50 hp]	To be used if <i>parameter 0-03 Regional Settings</i> is set for [1] <i>North America</i> (parameter not visible if [0] <i>International</i> is selected). Set power consumption at 85% speed level. This function is used for storing values necessary for tuning no-flow detection.	

3.19.4 22-4* Sleep Mode

If the load on the system allows for stop of the motor and the load is monitored, the motor can be stopped by activating the sleep mode function. This is not a normal stop command, but ramps the motor down to 0 RPM and stops energizing the motor. When in sleep mode, certain conditions are monitored to find out when load has been applied to the system again.

Sleep mode can be activated either from the no-flow detection/minimum speed detection or via an external signal applied to 1 of the digital inputs (programmed via the parameters for configuration of the digital inputs, *parameter group 5-1* Digital Inputs*).

To facilitate use of, for example, an electro-mechanical flow switch to detect a no-flow condition and activate sleep mode, the action takes place at raising edge of the external signal applied. Otherwise, the frequency converter would never come out of sleep mode again as the signal would be steadily connected.

If *parameter 25-26 Destage At No-Flow* is set for [1] *Enabled*, activating sleep mode applies a command to the cascade controller (if enabled) to start destaging of lag pumps (fixed speed) before stopping the lead pump (variable speed).

When entering sleep mode, the lower status line in the display shows sleep mode.

See also signal flow chart, *Figure 3.63*.

There are 3 different ways of using the sleep mode function:

- Boost system with pressure feedback.
- System with pressure feedback.
- Boost system without pressure feedback.

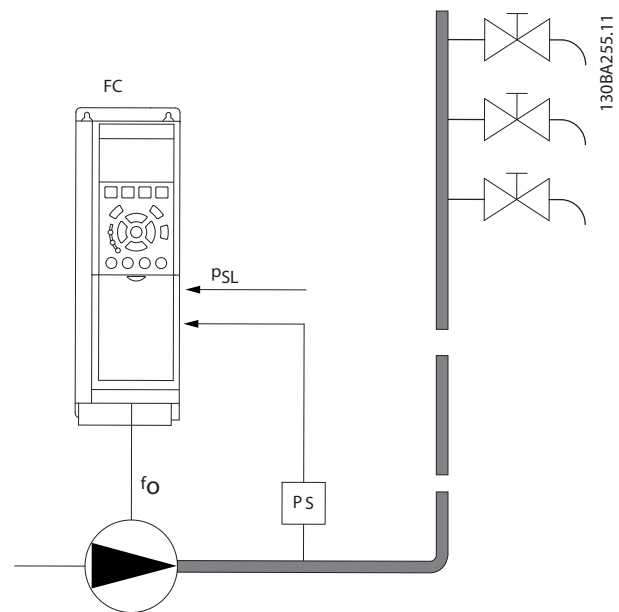

FC	Frequency converter
f _o	Frequency out
P _S	P system
P _{SL}	P setpoint

Figure 3.66 Sleep Mode Function

In systems where the integrated PI controller is used for controlling pressure or temperature, for example boost systems with a pressure feedback signal applied to the frequency converter from a pressure transducer:

1. Set *parameter 1-00 Configuration Mode* for [3] *Closed loop*.
2. Configure the PI controller for reference and feedback signals.

Figure 3.67 shows a boost system.

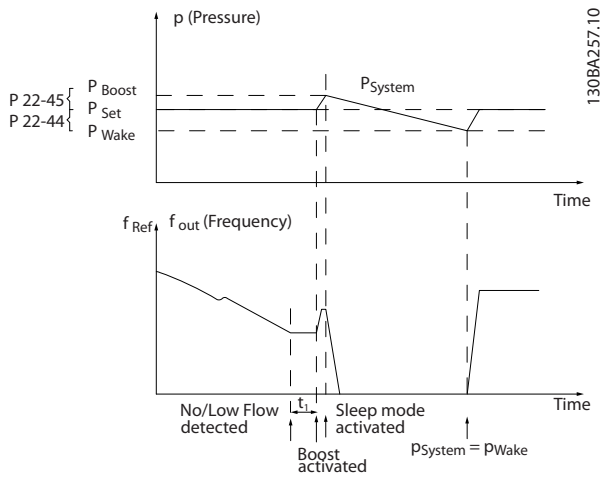

Figure 3.67 Boost System with Pressure Feedback

If no flow is detected, the frequency converter increases the setpoint for pressure to ensure a slight overpressure in the system (boost to be set in *parameter 22-45 Setpoint Boost*). The feedback from the pressure transducer is monitored. When this pressure has dropped with a set percentage below the normal setpoint for pressure (P_{set}), the motor ramps up again. The pressure is then controlled for reaching the set value (P_{set}).

In systems where the pressure or temperature is controlled by an external PI controller, the wake-up conditions cannot be based on feedback from the pressure/temperature transducer as the setpoint is not known. In the example with a boost system, pressure P_{set} is not known. Set *parameter 1-00 Configuration Mode* for [1] Open loop. Example: Boost system.

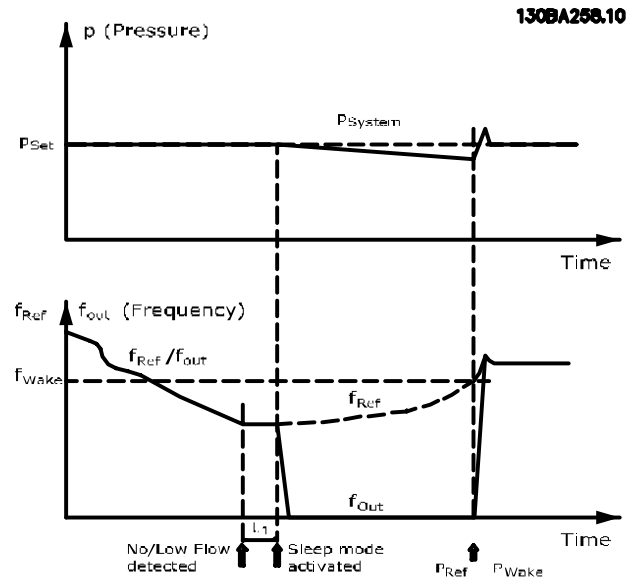

Figure 3.69 Boost System without Pressure Feedback

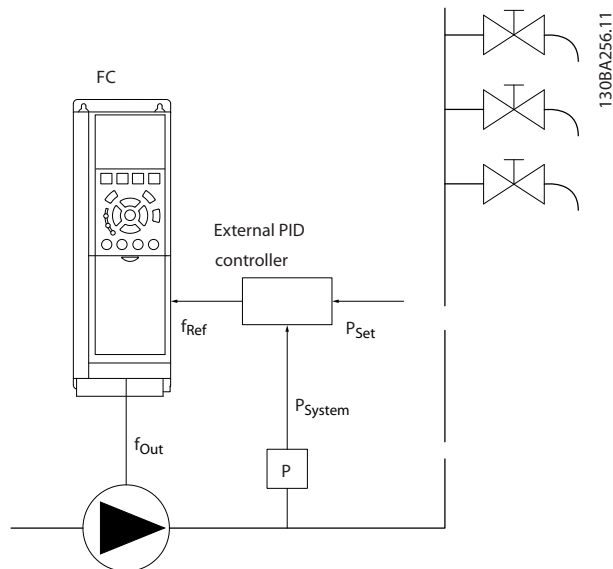

Figure 3.68 System with Pressure Feedback

When low power or low speed is detected, the motor is stopped, but the reference signal (f_{ref}) from the external controller is still monitored, and because of the low pressure created, the controller increases the reference signal to gain pressure. When the reference signal has reached a set value f_{wake} , the motor restarts.

The speed is set manually by an external reference signal (remote reference). Set the settings (*parameter group 22-3* No-Flow Power Tuning*) for tuning of the no-flow function to default.

	Internal PI controller (parameter 1-00 Configuration Mode)		External PI controller or manual control (parameter 1-00 Configuration Mode)	
	Sleep mode	Wake up	Sleep mode	Wake up
No-flow detection (pumps only)	Yes	–	Yes (except manual setting of speed)	–
Low-speed detection	Yes	–	Yes	–
External signal	Yes	–	Yes	–
Pressure/temperature (transmitter connected)	–	Yes	–	No
Output frequency	–	No	–	Yes

Table 3.29 Overview of Configuration Possibilities

NOTICE!

Sleep mode is not active when local reference is active (set speed manually with the navigation keys on the LCP). See *parameter 3-13 Reference Site*.

Does not work in hand-on mode. Carry out auto set-up in open loop before setting input/output in closed loop.

22-40 Minimum Run Time		
Range:	Function:	
60 s* [0 - 600 s]	Set the minimum running time for the motor after a start command (digital input or fieldbus) before entering sleep mode.	

22-41 Minimum Sleep Time		
Range:	Function:	
30 s* [0 - 600 s]	Set the minimum time for staying in sleep mode. This setting overrides any wake-up conditions.	

22-42 Wake-up Speed [RPM]		
Range:	Function:	
Size related* [0 - par. 4-13 RPM]	To be used if <i>parameter 0-02 Motor Speed Unit</i> has been set for [0] RPM (parameter not visible if [1] Hz is selected). Only to be used if <i>parameter 1-00 Configuration Mode</i> is set for [0] Open loop and an external controller applies speed reference. Set the reference speed at which the sleep mode should be canceled.	

22-43 Wake-up Speed [Hz]		
Range:	Function:	
Size related* [0 - par. 4-14 Hz]	To be used if <i>parameter 0-02 Motor Speed Unit</i> has been set for [1] Hz (parameter not visible if [0] RPM is selected). Only to be used if <i>parameter 1-00 Configuration Mode</i> is set for [0] Open Loop and speed reference is applied by an external controller controlling the pressure.	

22-43 Wake-up Speed [Hz]		
Range:	Function:	
	Set the reference speed at which the sleep mode should be canceled.	

22-44 Wake-up Ref./FB Difference		
Range:	Function:	
10 %* [0 - 100 %]	Only to be used if <i>parameter 1-00 Configuration Mode</i> is set to [3] Closed Loop and the integrated PI controller is used for controlling the pressure. Set the pressure drop allowed in percentage of setpoint for the pressure (P_{set}) before canceling the sleep mode.	
	NOTICE! If used in applications where the integrated PI controller is set for inverse control in <i>parameter 20-71 Controller Performance</i> , the value set in <i>parameter 22-44 Wake-up Ref./FB Difference</i> is automatically added.	

22-45 Setpoint Boost		
Range:	Function:	
0 %* [-100 - 100 %]	Only to be used if <i>parameter 1-00 Configuration Mode</i> is set to [3] Closed Loop and the integrated PI controller is used. In systems with, for example, constant pressure control, it is advantageous to increase the system pressure before the motor is stopped. This extends the time in which the motor is stopped and helps to avoid frequent start/stop. Set the overpressure/overtemperature in percentage of setpoint for the pressure (P_{set})/temperature before entering sleep mode. If set to 5%, the boost pressure is $P_{set} \times 1.05$. The negative values can be used, for example, in cooling tower control where a negative change is needed.	

22-46 Maximum Boost Time		
Range:	Function:	
60 s*	[0 - 600 s]	Only to be used if <i>parameter 1-00 Configuration Mode</i> is set to [3] <i>Closed Loop</i> and the integrated PI controller is used for controlling the pressure. Set the maximum time for which boost mode is allowed. If the set time is exceeded, sleep mode is entered, not waiting for the set boost pressure to be reached.

3.19.5 22-5* End of Curve

The end-of-curve conditions occur when a pump is yielding a too large volume to ensure the set pressure. This can occur if there is a leakage in the distribution pipe system.

The frequency converter initiates the function selected in *parameter 22-50 End of Curve Function* in the following conditions:

- The frequency converter is running at maximum speed (*parameter 4-13 Motor Speed High Limit [RPM]* or *parameter 4-14 Motor Speed High Limit [Hz]*).
- The feedback signal is less than the pressure setpoint by a value that is equal to or exceeds 2.5% of the value in *parameter 3-03 Maximum Reference*.
- The conditions are active for a time set in *parameter 22-51 End of Curve Delay*.

It is possible to obtain a signal on 1 of the digital outputs by selecting [192] *End of Curve* in *parameter group 5-3* Digital Outputs* and/or *parameter group 5-4* Relays*. The signal is present when an end-of-curve condition occurs and the selection in *parameter 22-50 End of Curve Function* is different from [0] *Off*. The end-of-curve function can only be used when operating with the built-in PID controller ([3] *Closed Loop* in *parameter 1-00 Configuration Mode*).

22-50 End of Curve Function		
Option:	Function:	
		NOTICE! Automatic restart resets the alarm and restarts the system.

22-50 End of Curve Function		
Option:	Function:	
		NOTICE! Do not set <i>parameter 14-20 Reset Mode</i> , to [13] <i>Infinite auto reset</i> , when <i>parameter 22-50 End of Curve Function</i> is set to [2] <i>Alarm</i> . Doing so causes the frequency converter to continuously cycle between running and stopping when an end-of-curve condition is detected. NOTICE! If the frequency converter is equipped with a constant speed bypass with an automatic bypass function that starts the bypass if the frequency converter experiences a persistent alarm condition, be sure to disable the automatic bypass function, if [2] <i>Alarm</i> or [3] <i>Man. Reset Alarm</i> is selected as the end-of-curve function.
[0]	Off	End-of-curve monitoring is not active.
*		
[1]	Warning	The frequency converter continues to run, but activates an end-of-curve warning (<i>warning 94, End of curve</i>). A frequency converter digital output or a serial communication bus can communicate a warning to other equipment.
[2]	Trip	The frequency converter stops running and activates an end-of-curve alarm (<i>alarm 94, End of curve</i>). A frequency converter digital output or a serial communication bus can communicate an alarm to other equipment.
[3]	Manual Reset Trip	The frequency converter stops running and activates an end-of-curve alarm (<i>alarm 94, End of curve</i>). A frequency converter digital output or a fieldbus can communicate an alarm to other equipment.
[4]	Stop and Trip	

22-51 End of Curve Delay		
Range:	Function:	
10 s*	[0 - 600 s]	When an end-of-curve condition is detected, a timer is activated. When the time set in this parameter expires, and the end-of-curve condition is steady during the entire period, the function set in <i>parameter 22-50 End of Curve Function</i> is activated. If the condition disappears before the timer expires, the timer is reset.

3.19.6 22-6* Broken Belt Detection

The broken-belt detection can be used in both closed-loop systems and open-loop systems for pumps and fans. If the estimated motor torque is below the broken belt torque value (*parameter 22-61 Broken Belt Torque*) and the frequency converter output frequency is above or equal to 15 Hz, the broken-belt function (*parameter 22-60 Broken Belt Function*) is performed.

22-60 Broken Belt Function		
Selects the action to be performed if the broken-belt condition is detected.		
Option:	Function:	
	<p>NOTICE! Do not set <i>parameter 14-20 Reset Mode</i> to [13] <i>Infinite auto reset</i>, when <i>parameter 22-60 Broken Belt Function</i> is set to [2] <i>Trip</i>. Doing so causes the frequency converter to continuously cycle between running and stopping when a broken-belt condition is detected.</p> <p>NOTICE! For frequency converters with constant-speed bypass. If an automatic bypass function starts the bypass at persistent alarm conditions, disable the bypass's automatic bypass function if [2] <i>Alarm</i> or [3] <i>Man. Reset Alarm</i> is selected as the broken-belt function.</p>	
[0] *	Off	
[1]	Warning	The frequency converter continues to run, but activates a broken-belt warning (<i>warning 95, Broken belt</i>). A frequency converter digital output or a serial communication bus can communicate a warning to other equipment.
[2]	Trip	The frequency converter stops running and activates a broken-belt alarm (<i>alarm 95, Broken belt</i>). A frequency converter digital output or a serial communication bus can communicate an alarm to other equipment.
[3]	Stop and Trip	
22-61 Broken Belt Torque		
Range:	Function:	
10 %*	[0 - 100 %]	Sets the broken-belt torque as a percentage of the rated motor torque.

22-62 Broken Belt Delay		
Range:		Function:
10 s	[0 - 600 s]	Sets the time for which the broken belt conditions must be active before carrying out the action selected in <i>parameter 22-60 Broken Belt Function</i> .

3.19.7 22-7* Short Cycle Protection

In some applications, a need for limiting the numbers of starts often exists. One way to do this is to ensure a minimum run time (time between a start and a stop) and a minimum interval between starts.

This means that any normal stop command can be overridden by *parameter 22-77 Minimum Run Time* and any normal start command (start/jog/freeze) can be overridden by *parameter 22-76 Interval between Starts*.

None of the 2 functions are active if hand-on mode or off mode have been activated via the LCP. If pressing [Hand On] or [Off], the 2 timers are reset to 0 and do not start counting until [Auto On] is pressed, and an active start command is applied.

22-75 Short Cycle Protection		
Option:		Function:
[0] *	Disabled	Timer set in <i>parameter 22-76 Interval between Starts</i> is disabled.
[1]	Enabled	Timer set in <i>parameter 22-76 Interval between Starts</i> is enabled.

22-76 Interval between Starts		
Range:		Function:
Size related*	[par. 22-77 - 3600 s]	Sets the minimum time between 2 starts. Any normal start command (start/jog/freeze) is disregarded until the timer has expired.

22-77 Minimum Run Time		
Range:		Function:
0 s*	[0 - par. 22-76 s]	<p>NOTICE! Does not work in cascade mode.</p> <p>Sets the minimum run time after a normal start command (start/jog/freeze). Any normal stop command is disregarded until the set time has expired. The timer starts counting following a normal start command (start/jog/freeze).</p> <p>A coast (inverse) or an external interlock command overrides the timer.</p>

22-78 Minimum Run Time Override		
Option:	Function:	
[0] *	Disabled	
[1]	Enabled	

22-79 Minimum Run Time Override Value		
Range:	Function:	
0 ProcessCtrlUnit*	[-999999.999 - 999999.999 ProcessCtrlUnit]	

3.19.8 22-8* Flow Compensation

In certain applications, it is not possible for a pressure transducer to be placed at a remote point in the system, and it can only be located close to the fan/pump outlet. Flow compensation operates by adjusting the setpoint according to the output frequency, which is almost proportional to flow. Thus, it compensates for higher losses at higher flow rates.

H_{DESIGN} (required pressure) is the setpoint for closed-loop (PI) operation of the frequency converter and is set as for closed-loop operation without flow compensation.

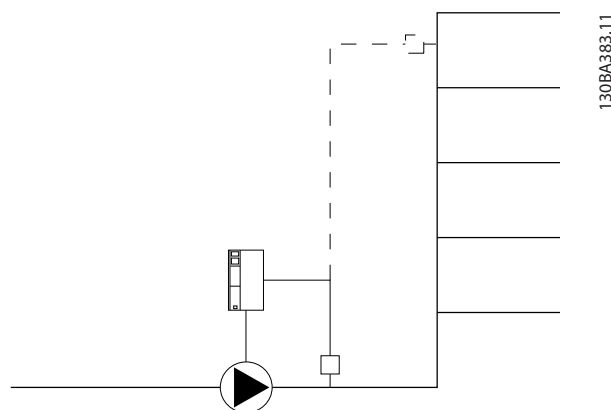

Figure 3.70 Flow Compensation Set-up

There are 2 methods which can be employed, depending on whether the speed at system design working point is known.

Parameter used	Speed at design point known	Speed at design point unknown
Parameter 22-80 Flow Compensation	+	+
Parameter 22-81 Square-linear Curve Approximation	+	+
Parameter 22-82 Work Point Calculation	+	+
Parameter 22-83 Speed at No-Flow [RPM]/parameter 22-84 Speed at No-Flow [Hz]	+	+
Parameter 22-85 Speed at Design Point [RPM]/parameter 22-86 Speed at Design Point [Hz]	+	-
Parameter 22-87 Pressure at No-Flow Speed	+	+
Parameter 22-88 Pressure at Rated Speed	-	+
Parameter 22-89 Flow at Design Point	-	+
Parameter 22-90 Flow at Rated Speed	-	+

Table 3.30 Speed at Design Point Known/Unknown

22-80 Flow Compensation		
Option:	Function:	
[0] *	Disabled	Setpoint compensation not active.
[1]	Enabled	Setpoint compensation is active. Enabling this parameter allows the flow-compensated setpoint operation.

22-81 Square-linear Curve Approximation		
Range:	Function:	
100 %*	[0 - 100 %]	NOTICE! Not visible when running in cascade.

22-81 Square-linear Curve Approximation		
Range:	Function:	
		Example 1 Adjustment of this parameter allows the shape of the control curve to be adjusted. 0=Linear 100%=Ideal shape (theoretical).

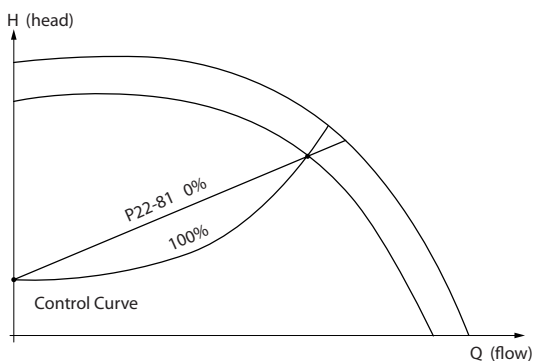

130BA388.11

Figure 3.71 Square-Linear Curve Approximation

22-82 Work Point Calculation

Option: Function:

Example 1

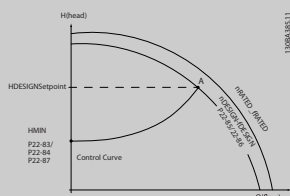

Figure 3.72 Speed at System Design Working Point is Known

From the datasheet showing characteristics for the specific equipment at different speeds, simply reading across from the H_{DESIGN} point and the Q_{DESIGN} point allows finding point A, which is the system design working point. The pump characteristics at this point should be identified and the associated speed programmed. Closing the valves and adjusting the speed until H_{MIN} has been achieved allows the speed at the no-flow point to be identified.

Adjustment of *parameter 22-81 Square-linear Curve Approximation* then allows the shape of the control curve to be adjusted infinitely.

Example 2

Speed at system design working point is not known: Where the speed at system design working point is unknown, another reference point on the control curve has to be determined based on the datasheet. Looking at the curve for the rated speed and plotting the design pressure (H_{DESIGN} , Point C), the flow at that pressure, Q_{RATED} , can be determined. Similarly, by plotting the design flow (Q_{DESIGN} , Point D), the pressure H_{DESIGN} at that flow can be determined. Knowing these 2 points on the pump curve, along with H_{MIN} as

22-82 Work Point Calculation

Option: Function:

described, allows the frequency converter to calculate the reference point B and thus to plot the control curve, which also includes the system design working point A.

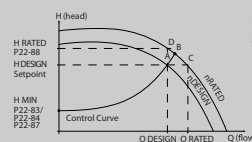

Figure 3.73 Speed at System Design Working Point is not Known

[0]	Disabled	Work point calculation not active. To be used if speed at design point is known.
*		
[1]	Enabled	Work point calculation is active. Enabling this parameter allows the calculation of the unknown system design working point at 50/60 Hz speed, from the input data set in: <ul style="list-style-type: none"> Parameter 22-83 Speed at No-Flow [RPM]. Parameter 22-84 Speed at No-Flow [Hz]. Parameter 22-87 Pressure at No-Flow Speed. Parameter 22-88 Pressure at Rated Speed. Parameter 22-89 Flow at Design Point. Parameter 22-90 Flow at Rated Speed.

22-83 Speed at No-Flow [RPM]

Range: Function:

Size related*	[0 - par. 22-85 RPM]	Resolution 1 RPM. Enter the speed of the motor in RPM at which flow is 0 and minimum pressure H_{MIN} is achieved. Alternatively, enter the speed in Hz in <i>parameter 22-84 Speed at No-Flow [Hz]</i> . If <i>parameter 0-02 Motor Speed Unit</i> is set to RPM, <i>parameter 22-85 Speed at Design Point [RPM]</i> should also be used. Closing the valves and reducing the speed until minimum pressure H_{MIN} is achieved determines this value.
---------------	-----------------------	--

22-84 Speed at No-Flow [Hz]		
Range:		Function:
Size related*	[0 - par. 22-86 Hz]	Resolution 0.033 Hz. Enter the motor speed in Hz at which flow has effectively stopped and minimum pressure H_{MIN} is achieved. Alternatively, enter the speed in RPM in <i>parameter 22-83 Speed at No-Flow [RPM]</i> . If <i>parameter 0-02 Motor Speed Unit</i> is set to Hz, <i>parameter 22-86 Speed at Design Point [Hz]</i> should also be used. Closing the valves and reducing the speed until minimum pressure H_{MIN} is achieved determines this value.

22-85 Speed at Design Point [RPM]		
Range:		Function:
Size related*	[0 - 60000 RPM]	Resolution 1 RPM. Only visible when <i>parameter 22-82 Work Point Calculation</i> is set to [0] Disabled. Enter the motor speed in RPM at which the system design working point is achieved. Alternatively, enter the speed in Hz in <i>parameter 22-86 Speed at Design Point [Hz]</i> . If <i>parameter 0-02 Motor Speed Unit</i> is set to RPM, <i>parameter 22-83 Speed at No-Flow [RPM]</i> should also be used.

22-86 Speed at Design Point [Hz]		
Range:		Function:
Size related*	[0.0 - par. 4-19 Hz]	Resolution 0.033 Hz. Only visible when <i>parameter 22-82 Work Point Calculation</i> is set to [0] Disabled. Enter the motor speed in Hz at which the system design working point is achieved. Alternatively, enter the speed in RPM in <i>parameter 22-85 Speed at Design Point [RPM]</i> . If <i>parameter 0-02 Motor Speed Unit</i> is set to Hz, <i>parameter 22-83 Speed at No-Flow [RPM]</i> should also be used.

22-87 Pressure at No-Flow Speed		
Range:		Function:
0*	[0 - par. 22-88]	Enter the pressure H_{MIN} corresponding to speed at no-flow in reference/feedback units.

22-88 Pressure at Rated Speed		
Also see <i>parameter 22-82 Work Point Calculation</i> .		
Range:		Function:
999999.999*	[par. 22-87 - 999999.999]	Enter the value corresponding to the pressure at rated speed, in reference/feedback units. This value can be defined using the pump datasheet.

22-89 Flow at Design Point		
Also, see <i>parameter 22-88 Pressure at Rated Speed</i> point A.		
Range:		Function:
0*	[0 - 999999.999]	Flow at design point (no units).

22-90 Flow at Rated Speed		
Also, see <i>parameter 22-82 Work Point Calculation</i> .		
Range:		Function:
Size related*	[0 - 999999999]	Enter the value corresponding to flow at rated speed. This value can be defined using the pump datasheet.

3.20 Parameters 23-** Time-based Functions

3.20.1 23-0* Timed Actions

Use timed actions for actions performed on a daily or weekly basis, for example different references for working hours/non-working hours. Up to 10 timed actions can be programmed in the frequency converter. Select the timed action number from the list when entering *parameter group 23-** Time-based Functions* from the LCP. *Parameter 23-00 ON Time* and *parameter 23-04 Occurrence* then refer to the selected timed action number. Each timed action is divided into an ON time and an OFF time, in which 2 different actions may be performed.

Display lines 2 and 3 in the LCP show the status for timed actions mode (*parameter 0-23 Display Line 2 Large* and *parameter 0-24 Display Line 3 Large*, setting [1643] *Timed Actions Status*).

NOTICE!

If commands are applied simultaneously to the digital inputs for constant OFF and constant ON, the timed actions mode changes to timed actions auto and the 2 commands are disregarded. If *parameter 0-70 Date and Time* is not set or the frequency converter is set to hand-on mode or OFF mode (for example via the LCP), the timed actions mode is changed to [0] *Disabled*. The timed actions have a higher priority than the same actions/commands activated by the digital inputs or the smart logic controller.

The actions programmed in timed actions are merged with corresponding actions from digital inputs, control word via bus, and smart logic controller, according to merge rules set up in *parameter group 8-5* Digital/Bus*.

NOTICE!

Program the clock (*parameter group 0-7* Clock Settings*) correctly for timed actions to function.

NOTICE!

When mounting VLT® Analog I/O Option MCB 109, a battery back-up of the date and time is included.

NOTICE!

The PC-based configuration tool MCT 10 Set-up Software comprises a special guide for easy programming of timed actions.

23-00 ON Time		
Array [10]		
Range:		Function:
Size related*	[0 - 0]	Sets the ON time for the timed action.
<p>NOTICE!</p> <p>The frequency converter has no back-up of the clock function. The set date/time resets to default (2000-01-01 00:00) after a power-down unless a real-time clock-module with back-up is installed. In <i>parameter 0-79 Clock Fault</i>, it is possible to program a warning if the clock has not been set properly, for example after a power-down.</p>		

23-01 ON Action		
Array [10]		
Option:		Function:
		<p>NOTICE!</p> <p>For options [32] <i>Set digital out A low</i>–[43] <i>Set digital out F high</i>, see also <i>parameter group 5-3* Digital Outputs</i> and <i>parameter group 5-4* Relays</i>.</p> <p>Select the action during ON time. See <i>parameter 13-52 SL Controller Action</i> for descriptions of the options.</p>
[0] *	Disabled	
[1]	No action	
[2]	Select set-up 1	
[3]	Select set-up 2	
[4]	Select set-up 3	
[5]	Select set-up 4	
[10]	Select preset ref 0	
[11]	Select preset ref 1	
[12]	Select preset ref 2	
[13]	Select preset ref 3	
[14]	Select preset ref 4	
[15]	Select preset ref 5	
[16]	Select preset ref 6	
[17]	Select preset ref 7	
[18]	Select ramp 1	

23-01 ON Action	
Option:	Function:
[19]	Select ramp 2
[22]	Run
[23]	Run reverse
[24]	Stop
[26]	DC Brake
[27]	Coast
[28]	Freeze output
[29]	Start timer 0
[30]	Start timer 1
[31]	Start timer 2
[32]	Set digital out A low
[33]	Set digital out B low
[34]	Set digital out C low
[35]	Set digital out D low
[36]	Set digital out E low
[37]	Set digital out F low
[38]	Set digital out A high
[39]	Set digital out B high
[40]	Set digital out C high
[41]	Set digital out D high
[42]	Set digital out E high
[43]	Set digital out F high
[60]	Reset Counter A
[61]	Reset Counter B
[62]	Counter A (up)
[63]	Counter A (down)
[64]	Counter B (up)
[65]	Counter B (down)
[70]	Start Timer 3
[71]	Start Timer 4
[72]	Start Timer 5
[73]	Start Timer 6
[74]	Start Timer 7
[80]	Sleep Mode
[81]	Derag
[82]	Reset Derag Counter
[90]	Set ECB Bypass Mode
[91]	Set ECB Drive Mode
[100]	Reset Alarms
[101]	Reset Flow Totalized Volume Counter
[102]	Reset Flow Actual Volume Counter

23-02 OFF Time	
Range:	Function:
Size related*	[0 - 0]
Sets the OFF time for the timed action.	
NOTICE!	
The frequency converter has no back-up of the clock function. The set date/time is reset to default (2000-01-01 00:00) after a power-down unless a real-time clock module with back-up is installed. In <i>parameter 0-79 Clock Fault</i> , it is possible to program a warning if the clock has not been set properly, for example after a power-down.	

23-03 OFF Action

Option:	Function:
[0] *	Disabled

Array [10]
See *parameter 23-01 ON Action* for available actions.

23-04 Occurrence		
Array [10]		
Option:	Function:	
	Select which days the timed action applies to. Specify working/non-working days in: <ul style="list-style-type: none"> • <i>Parameter 0-81 Working Days.</i> • <i>Parameter 0-82 Additional Working Days.</i> • <i>Parameter 0-83 Additional Non-Working Days.</i> 	
[0] *	All days	
[1]	Working days	
[2]	Non-working days	
[3]	Monday	
[4]	Tuesday	
[5]	Wednesday	
[6]	Thursday	
[7]	Friday	
[8]	Saturday	
[9]	Sunday	
[10]	Day 1 of month	
[11]	Day 2 of month	
[12]	Day 3 of month	
[13]	Day 4 of month	
[14]	Day 5 of month	
[15]	Day 6 of month	
[16]	Day 7 of month	

23-04 Occurrence		
Array [10]		
Option:	Function:	
[17]	Day 8 of month	
[18]	Day 9 of month	
[19]	Day 10 of month	
[20]	Day 11 of month	
[21]	Day 12 of month	
[22]	Day 13 of month	
[23]	Day 14 of month	
[24]	Day 15 of month	
[25]	Day 16 of month	
[26]	Day 17 of month	
[27]	Day 18 of month	
[28]	Day 19 of month	
[29]	Day 20 of month	
[30]	Day 21 of month	
[31]	Day 22 of month	
[32]	Day 23 of month	
[33]	Day 24 of month	
[34]	Day 25 of month	
[35]	Day 26 of month	
[36]	Day 27 of month	
[37]	Day 28 of month	
[38]	Day 29 of month	
[39]	Day 30 of month	
[40]	Day 31 of month	

3.20.2 23-1* Maintenance

Wear and tear calls for periodic inspection and service of elements in the application, for example motor bearings, feedback sensors, seals, and filters. With preventive maintenance, the service intervals may be programmed into the frequency converter. The frequency converter gives a message when maintenance is required. 20 preventive maintenance events can be programmed into the frequency converter.

Specify the following for each event:

- Maintenance item (for example, motor bearings).
- Maintenance action (for example, replacement).
- Maintenance time base (for example, running hours, or a specific date and time).
- Maintenance time interval or the date and time of next maintenance.

NOTICE!

To disable a preventive maintenance event, set the associated *parameter 23-12 Maintenance Time Base* to [0] Disabled.

Preventive maintenance can be programmed from the LCP, but use of the PC-based MCT 10 Set-up Software is recommended.

ID	Name	Setup 1	Setup 2	Setup 3	Setup 4
2310.0	Maintenance Item	Motor bearings	Motor bearings	Motor bearings	Motor bearings
2310.1	Maintenance Item	Motor bearings	Motor bearings	Motor bearings	Motor bearings
2310.2	Maintenance Item	Motor bearings	Motor bearings	Motor bearings	Motor bearings
2310.3	Maintenance Item	Motor bearings	Motor bearings	Motor bearings	Motor bearings
2310.4	Maintenance Item	Motor bearings	Motor bearings	Motor bearings	Motor bearings
2310.5	Maintenance Item	Motor bearings	Motor bearings	Motor bearings	Motor bearings
2310.6	Maintenance Item	Motor bearings	Motor bearings	Motor bearings	Motor bearings
2310.7	Maintenance Item	Motor bearings	Motor bearings	Motor bearings	Motor bearings
2310.8	Maintenance Item	Motor bearings	Motor bearings	Motor bearings	Motor bearings
2310.9	Maintenance Item	Motor bearings	Motor bearings	Motor bearings	Motor bearings
2310.10	Maintenance Item	Motor bearings	Motor bearings	Motor bearings	Motor bearings
2310.11	Maintenance Item	Motor bearings	Motor bearings	Motor bearings	Motor bearings
2310.12	Maintenance Item	Motor bearings	Motor bearings	Motor bearings	Motor bearings
2310.13	Maintenance Item	Motor bearings	Motor bearings	Motor bearings	Motor bearings
2310.14	Maintenance Item	Motor bearings	Motor bearings	Motor bearings	Motor bearings
2310.15	Maintenance Item	Motor bearings	Motor bearings	Motor bearings	Motor bearings
2310.16	Maintenance Item	Motor bearings	Motor bearings	Motor bearings	Motor bearings
2310.17	Maintenance Item	Motor bearings	Motor bearings	Motor bearings	Motor bearings
2310.18	Maintenance Item	Motor bearings	Motor bearings	Motor bearings	Motor bearings
2310.19	Maintenance Item	Motor bearings	Motor bearings	Motor bearings	Motor bearings
2311.0	Maintenance Action	Lubricate	Lubricate	Lubricates	Lubricate
2311.2	Maintenance Action	Lubricate	Lubricate	Lubricates	Lubricate
2311.3	Maintenance Action	Lubricate	Lubricate	Lubricates	Lubricate
2311.4	Maintenance Action	Lubricate	Lubricate	Lubricates	Lubricate
2311.5	Maintenance Action	Lubricate	Lubricate	Lubricates	Lubricate
2311.6	Maintenance Action	Lubricate	Lubricate	Lubricates	Lubricate

Figure 3.74 MCT 10 Set-up Software

The LCP indicates (with a wrench icon and letter M) when it is time for a preventive maintenance action and can be programmed to be indicated on a digital output in *parameter group 5-3* Digital Outputs*. The preventive maintenance status is shown in *parameter 16-96 Maintenance Word*. A preventive maintenance indication can be reset from a digital input, the FC bus, or manually from the LCP through *parameter 23-15 Reset Maintenance Word*.

A maintenance log with the latest 10 loggings can be read from *parameter group 18-0* Maintenance Log* and via [Alarm Log] on the LCP after selecting maintenance log.

NOTICE!

The preventive maintenance events are defined in a 20-element array. Hence, each preventive maintenance event must use the same array element index in *parameter 23-10 Maintenance Item* to *parameter 23-14 Maintenance Date and Time*.

23-10 Maintenance Item		
Array [20]		
Option:	Function:	
	Array with 20 elements shown below the parameter number in the display. Press [OK] and step between elements with [◀], [▶], [▲], and [▼].	
	Select the item to be associated with the preventive maintenance event.	
[1] *	Motor bearings	
[2]	Fan bearings	
[3]	Pump bearings	
[4]	Valve	

23-10 Maintenance Item		
Array [20]		
Option:	Function:	
[5]	Pressure transmitter	
[6]	Flow transmitter	
[7]	Temperature transm.	
[8]	Pump seals	
[9]	Fan belt	
[10]	Filter	
[11]	Drive cooling fan	
[12]	System health check	
[13]	Warranty	
[20]	Maintenance Text 0	
[21]	Maintenance Text 1	

23-10 Maintenance Item	
Array [20]	
Option:	Function:
[22]	Maintenance Text 2
[23]	Maintenance Text 3
[24]	Maintenance Text 4
[25]	Maintenance Text 5
[26]	Service log full

23-11 Maintenance Action	
Array [20]	
Option:	Function:
	Select the action to be associated with the preventive maintenance event.
[1] *	Lubricate
[2]	Clean
[3]	Replace
[4]	Inspect/Check
[5]	Overhaul
[6]	Renew
[7]	Check
[20]	Maintenance Text 0
[21]	Maintenance Text 1
[22]	Maintenance Text 2
[23]	Maintenance Text 3
[24]	Maintenance Text 4
[25]	Maintenance Text 5
[28]	Clear logs

23-12 Maintenance Time Base	
Array [20]	
Option:	Function:
	Select the time base to be associated with the preventive maintenance event.
[0] *	Disabled Disables the preventive maintenance event.
[1]	Running Hours The number of hours the motor has run. Running hours are not reset at power-on. Specify the maintenance time interval in <i>parameter 23-13 Maintenance Time Interval</i> .
[2]	Operating Hours The number of hours the frequency converter has run. Operating hours are not reset at power-on. Specify the maintenance time interval in <i>parameter 23-13 Maintenance Time Interval</i> .
[3]	Date & Time Uses the internal clock. Specify the date and time of the next maintenance occurrence in <i>parameter 23-14 Maintenance Date and Time</i> .

23-13 Maintenance Time Interval	
Array [20]	
Range:	Function:
1 h*	[1 - 2147483647 h] Set the interval associated with the current preventive maintenance event. This parameter is only used if [1] <i>Running Hours</i> or [2] <i>Operating Hours</i> is selected in <i>parameter 23-12 Maintenance Time Base</i> . The timer is reset from <i>parameter 23-15 Reset Maintenance Word</i> .
	Example A preventive maintenance event is set up Monday at 8:00. <i>Parameter 23-12 Maintenance Time Base</i> is [2] <i>Operating hours</i> and <i>parameter 23-13 Maintenance Time Interval</i> is 7 x 24 hours=168 hours. Next maintenance event is indicated the following Monday at 8:00. If this maintenance event is not reset until Tuesday at 9:00, the next occurrence is the following Tuesday at 9:00.

23-14 Maintenance Date and Time	
Array [20]	
Range:	Function:
Size related*	[0 - 0] Set the date and time for next maintenance occurrence if the preventive maintenance event is based on date/time. Date format depends on the setting in <i>parameter 0-71 Date Format</i> while the time format depends on the setting in <i>parameter 0-72 Time Format</i> .
	<u>NOTICE!</u> The frequency converter has no back-up of the clock function. The set date/time is reset to default (2000-01-01 00:00) after a power-down. In <i>parameter 0-79 Clock Fault</i> , it is possible to program a warning if the clock has not been set properly, for example after a power-down. Set the time at least 1 hour later than actual time.
	<u>NOTICE!</u> When mounting a VLT® Analog I/O option MCB 109 option card, a battery back-up of the date and time is included.

23-15 Reset Maintenance Word		
Option:	Function:	
		<p>NOTICE!</p> <p>When messages are reset, maintenance item, action, and maintenance date/time are not canceled.</p> <p><i>Parameter 23-12 Maintenance Time Base is set to [0] Disabled.</i></p> <p>Set this parameter to [1] Do reset to reset the maintenance word in <i>parameter 16-96 Maintenance Word</i> and reset the message shown in the LCP. This parameter changes back to [0] Do not reset when pressing [OK].</p>
[0] *	Do not reset	
[1]	Do reset	

23-16 Maintenance Text		
Array [6]		
Range:	Function:	
0*	[0 - 20]	<p>6 individual texts (Maintenance Text 0...Maintenance Text 5) can be written for use in either <i>parameter 23-10 Maintenance Item</i> or <i>parameter 23-11 Maintenance Action</i>.</p> <p>The text is written according to the guidelines in <i>parameter 0-37 Display Text 1</i>.</p>

3.20.3 23-5* Energy Log

The frequency converter is continuously accumulating the consumption of the motor controlled, based on the actual power yielded by the frequency converter.

This data can be used for an energy log function allowing to compare and structure the information about the energy consumption related to time.

There are 2 functions:

- Data related to a pre-programmed period, defined by a set date and time for start.
- Data related to a predefined period back in time, for example last 7 days within the pre-programmed period.

For each of the above 2 functions, the data is stored in several counters allowing for selecting time frame and a split on hours, days, or weeks.

The period/split (resolution) can be set in *parameter 23-50 Energy Log Resolution*.

The data is based on the value registered by the kWh counter in the frequency converter. This counter value can be read in *parameter 15-02 kWh Counter* containing the accumulated value since the first power-up or latest reset of the counter (*parameter 15-06 Reset kWh Counter*).

All data for the energy log is stored in counters, which can be read from *parameter 23-53 Energy Log*.

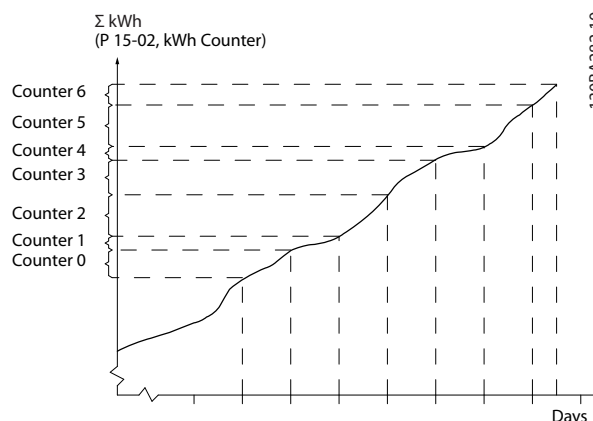

Figure 3.75 Energy Log Graph

Counter 00 always contains the oldest data. A counter covers a period from XX:00 to XX:59 if hours or 00:00 to 23:59 if days.

If logging either the last hours or last days, the counters shift contents at XX:00 every hour or at 00:00 every day. The counter with highest index is always subject to update (containing data for the actual hour since XX:00 or the actual day since 00:00).

The contents of counters can be shown as bars on the LCP. Select *Quick Menu, Loggings, Energy Log: Trending Continued Bin/Trending Timed Bin/Trending Comparison*.

23-50 Energy Log Resolution		
Option:	Function:	
	<p>NOTICE!</p> <p>The frequency converter has no back-up of the clock function. The set date/time resets to default (2000-01-01 00:00) after a power-down unless a real-time clock-module with back-up is installed. Therefore, the logging is stopped until date/time is readjusted in <i>parameter 0-70 Date and Time</i>. In <i>parameter 0-79 Clock Fault</i>, it is possible to program a warning if the clock has not been set properly, for example after a power-down.</p> <p>Select the type of period for logging consumption: [0] Hour of Day, [1] Day of Week, or [2] Day of Month. The counters contain the logging data from the programmed date/time for start (<i>parameter 23-51 Period Start</i>) and the numbers of hours/days as programmed for (<i>parameter 23-50 Energy Log Resolution</i>). The logging starts on the date programmed in <i>parameter 23-51 Period Start</i> and continues until 1 day/week/month has passed. The counters contain data for 1 day, 1 week, or 5 weeks back in time, and up to the actual time.</p> <p>The logging starts at the date programmed in <i>parameter 23-51 Period Start</i>. In all cases, the period split refers to operating hours (time where frequency converter is powered up).</p>	
[0]	Hour of Day	
[1]	Day of Week	
[2]	Day of Month	
[5] *	Last 24 Hours	
[6]	Last 7 Days	
[7]	Last 5 Weeks	

23-51 Period Start		
Range:	Function:	
Size related* [0 - 0]	<p>NOTICE!</p> <p>When mounting VLT® Analog I/O option MCB 109, a battery back-up of the date and time is included.</p>	

23-51 Period Start		
Range:	Function:	
	<p>Set the date and time at which the energy log starts updating the counters. First, data is stored in counter [00] and start at the time/date programmed in this parameter.</p> <p>Date format depends on setting in <i>parameter 0-71 Date Format</i> and time format on setting in <i>parameter 0-72 Time Format</i>.</p>	

23-53 Energy Log		
Array [31]		
Range:	Function:	
0* [0 - 4294967295]	<p>NOTICE!</p> <p>All counters are automatically reset when changing the setting in <i>parameter 23-50 Energy Log Resolution</i>. At overflow, the update of the counters stops at maximum value.</p> <p>NOTICE!</p> <p>When mounting VLT® Analog I/O Option MCB 109 option card, a battery back-up of the date and time is included.</p> <p>Array with several elements equal to the number of counters ([00]-[xx] below parameter number in display). Press [OK] and step between elements with [▲] and [▼].</p> <p>Array elements:</p>  <p>The diagram shows a vertical stack of seven boxes representing energy meter counters. From bottom to top, they are labeled: 'Energy meter 23-53 Energy meter [00]', 'Energy meter 23-53 Energy meter [01]', 'Energy meter 23-53 Energy meter [02]', 'Energy meter 23-53 Energy meter [03]', 'Energy meter 23-53 Energy meter [04]', 'Energy meter 23-53 Energy meter [05]', and 'Energy meter 23-53 Energy meter [06]'. A double-headed arrow is positioned to the right of the stack, indicating that the user can navigate between these elements.</p>	
	<p>Data from the latest period is stored in the counter with the highest index.</p> <p>At power-down, all counter values are stored and resumed at next power-up.</p>	

Figure 3.76 Energy Log

23-54 Reset Energy Log		
Option:	Function:	
		Select [1] Do reset to reset all values in the energy log counters shown in parameter 23-53 Energy Log. After pressing OK, the setting of the parameter value automatically changes to [0] Do not reset.
[0] *	Do not reset	
[1]	Do reset	

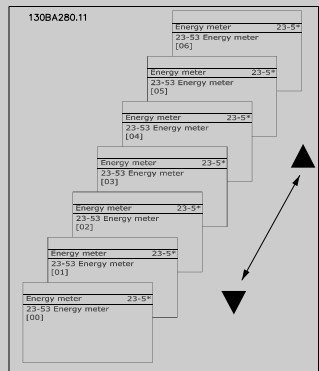
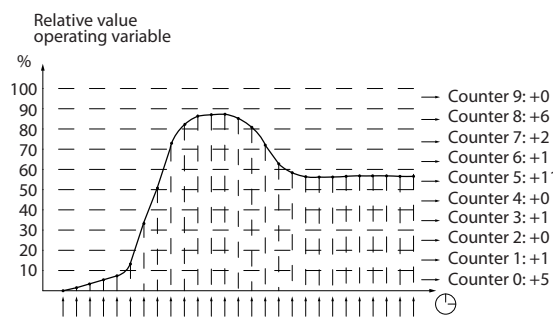

Figure 3.77 Time and Relative Values

3.20.4 23-6* Trending

Trending is used to monitor a process variable over time and record how often the data falls into each of 10 user-defined data ranges. This is a convenient tool to obtain a quick overview indicating where to focus on improvement of operation.

2 sets of data for trending can be created to make it possible to compare current values for a selected operating variable with data for a certain reference period, for the same variable. This reference period can be pre-programmed (parameter 23-63 Timed Period Start and parameter 23-64 Timed Period Stop). The 2 sets of data can be read from parameter 23-61 Continuous Bin Data (current) and parameter 23-62 Timed Bin Data (reference).

It is possible to create trending for the following operation variables:

- Power.
- Current.
- Output frequency.
- Motor speed.

The trending function includes 10 counters (forming a bin) for each set of data containing the numbers of registrations reflecting how often the operating variable is within each of 10 pre-defined intervals. The sorting is based on a relative value of the variable.

The relative value for the operating variable is determined as:

- Actual/rated x 100% - for power and current.
- Actual/max x 100% - for output frequency and motor speed.

The size of each interval can be adjusted individually, but is 10% for each as default. Power and current can exceed rated value, but those registrations are included in 90–100% (MAX) counter.

Once per second, the value of the operating variable selected is registered. If a value has been registered to equal 13%, the counter 10 to <20% is updated with the value 1. If the value stays at 13% for 10 s, 10 is added to the counter value.

The contents of counters can be shown as bars on the LCP. Select Quick Menu⇒Loggings: Trending Continued Bin/Trending Timed Bin/Trending Comparison.

NOTICE!

The counters start counting whenever the frequency converter is powered up. A power cycle shortly after a reset resets the counters. EEPROM data is updated once per hour.

23-60 Trend Variable		
Option:	Function:	
		Select the required operating variable to be monitored for trending.
[0]	Power [kW]	Power yielded to the motor. Reference for the relative value is the rated motor power programmed in parameter 1-20 Motor Power [kW] or parameter 1-21 Motor Power [HP]. The actual value can be read in parameter 16-10 Power [kW] or parameter 16-11 Power [hp].
[1]	Current [A]	Output current to the motor. Reference for the relative value is the rated motor current programmed in parameter 1-24 Motor Current. The actual value can be read in parameter 16-14 Motor current.
[2] *	Frequency [Hz]	Output frequency to the motor. Reference for the relative value is the maximum output frequency programmed in parameter 4-14 Motor Speed High Limit [Hz]. The actual value can be read in parameter 16-13 Frequency.

23-60 Trend Variable		
Option:	Function:	
[3]	Motor Speed [RPM]	Reference for the relative value is the maximum motor speed programmed in <i>parameter 4-13 Motor Speed High Limit [RPM]</i> .

23-61 Continuous Bin Data		
Range:	Function:	
0* [0 - 4294967295]	<p>Array with 10 elements ([0]-[9] below parameter number in display). Press [OK] and step between elements with [▲] and [▼].</p> <p>10 counters with the frequency of occurrence for the operating variable monitored, sorted according to the following intervals:</p> <ul style="list-style-type: none"> Counter [0]: 0–<10%. Counter [1]: 10–<20%. Counter [2]: 20–<30%. Counter [3]: 30–<40%. Counter [4]: 40–<50%. Counter [5]: 50–<60%. Counter [6]: 60–<70%. Counter [7]: 70–<80%. Counter [8]: 80–<90%. Counter [9]: 90–<100% or maximum. <p>The above minimum limits for the intervals are the default limits. These can be changed in <i>parameter 23-65 Minimum Bin Value</i>.</p> <p>Starts to count when the frequency converter is powered up for the first time. All counters can be reset to 0 in <i>parameter 23-66 Reset Continuous Bin Data</i>.</p>	

23-62 Timed Bin Data		
Array [10]		
Range:	Function:	
0* [0 - 4294967295]	<p>Array with 10 elements ([0]-[9] below parameter number in display). Press [OK] and step between elements with [▲] and [▼].</p> <p>10 counters with the frequency of occurrence for the operating data monitored sorted according to the intervals as for <i>parameter 23-61 Continuous Bin Data</i>.</p> <p>Starts to count at the date/time programmed in <i>parameter 23-63 Timed Period Start</i>, and stops at the time/date programmed in <i>parameter 23-64 Timed Period Stop</i>. All</p>	

23-62 Timed Bin Data		
Array [10]		
Range:	Function:	
	counters can be reset to 0 in <i>parameter 23-67 Reset Timed Bin Data</i> .	

23-63 Timed Period Start		
Array [10]		
Range:	Function:	
Size related* [0 - 0]	<p>NOTICE!</p> <p>The frequency converter has no back-up of the clock function. The set date/time is reset to default (2000-01-01 00:00) after a power-down unless a real-time clock-module with back-up is installed. Therefore, the logging is stopped until date/time is readjusted in <i>parameter 0-70 Date and Time</i>. In <i>parameter 0-79 Clock Fault</i>, it is possible to program a warning if the clock has not been set properly, for example after a power-down.</p> <p>NOTICE!</p> <p>When mounting VLT® Analog I/O option MCB 109, a battery back-up of the date and time is included.</p> <p>Set the date and time at which the trending starts the update of the timed bin counters.</p> <p>Date format depends on setting in <i>parameter 0-71 Date Format</i>, and time format on setting in <i>parameter 0-72 Time Format</i>.</p>	

23-64 Timed Period Stop		
Range:	Function:	
Size related* [0 - 0]	<p>NOTICE!</p> <p>When mounting VLT® Analog I/O Option MCB 109, a battery back-up of the date and time is included.</p> <p>Set the date and time at which the trend analyses must stop updating the timed bin counters.</p> <p>Date format depends on the setting in <i>parameter 0-71 Date Format</i>, and time format on the setting in <i>parameter 0-72 Time Format</i>.</p>	

23-65 Minimum Bin Value		
Range:		Function:
Size related*	[0 - 100 %]	Array with 10 elements ([0]–[9] below parameter number in display). Press [OK] and step between elements with [▲] and [▼]. Set the minimum limit for each interval in <i>parameter 23-61 Continuous Bin Data</i> and <i>parameter 23-62 Timed Bin Data</i> . Example: If selecting [1] counter and changing setting from 10% to 12%, [0] counter is based on the interval 0 to <12% and [1] counter on interval 12 to <20%.

23-66 Reset Continuous Bin Data		
Option:		Function:
[0] *	Do not reset	Select [1] Do reset to reset all values in <i>parameter 23-61 Continuous Bin Data</i> . After pressing [OK], the setting of the parameter value automatically changes to [0] Do not reset.
[1]	Do reset	

23-67 Reset Timed Bin Data		
Option:		Function:
		Select [1] Do reset to reset all counters in <i>parameter 23-62 Timed Bin Data</i> . After pressing [OK], the setting of the parameter value automatically changes to [0] Do not reset.
[0] *	Do not reset	
[1]	Do reset	

3.20.5 23-8* Payback Counter

The Payback Counter feature can give a rough calculation of payback if the frequency converter has been installed in an existing plant to ensure energy saving by changing from fixed to variable speed control. Reference for the savings is a set value to show the average power yielded before the upgrade with variable speed control.

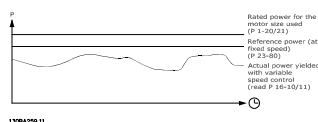

Figure 3.78 Comparison of the Reference Power and Actual Power

The difference between the reference power at fixed speed and the actual power yielded with speed control shows the actual saving.

As value for the fixed speed case, the rated motor size (kW) is multiplied by a factor (set in %) showing the power yielded at fixed speed. The difference between this reference power and the actual power is accumulated and stored. Read the difference in energy in *parameter 23-83 Energy Savings*.

The accumulated value for the difference in power consumption is multiplied by the energy cost in local currency and the investment is subtracted. Read this calculation for cost savings in *parameter 23-84 Cost Savings*.

$$\text{Cost savings} = (\sum (\text{reference power} - \text{actual power})) \times \text{energy cost} - \text{extra cost}$$

Breakeven (payback) occurs when the value read in the parameter turns from negative to positive.

It is not possible to reset the energy savings counter, but the counter can be stopped any time by setting *parameter 23-80 Power Reference Factor* to 0.

Parameter for settings	
Rated motor power	<i>Parameter 1-20 Motor Power [kW]</i>
Power reference factor in %	<i>Parameter 23-80 Power Reference Factor</i>
Energy cost per kWh	<i>Parameter 23-81 Energy Cost</i>
Investment	<i>Parameter 23-82 Investment</i>
Parameters for readout	
Energy savings	<i>Parameter 23-83 Energy Savings</i>
Actual power	<i>Parameter 16-10 Power [kW]/ parameter 16-11 Power [hp]</i>
Cost savings	<i>Parameter 23-84 Cost Savings</i>

Table 3.31 Parameter Overview

23-80 Power Reference Factor		
Range:		Function:
100 % *	[0 - 100 %]	Set the percentage of the rated motor size (set in <i>parameter 1-20 Motor Power [kW]</i> or <i>parameter 1-21 Motor Power [HP]</i>), which shows the average power yielded at the time running with fixed speed (before upgrade with variable speed control). Set a value different from 0 to start counting.

23-81 Energy Cost		
Range:		Function:
1*	[0 - 999999.99]	Set the actual cost for a kWh in local currency. If the energy cost is changed later on, it impacts the calculation for the entire period.

23-82 Investment		
Range:		Function:
0*	[0 - 999999999]	Set the value of the investment spent on upgrading the plant with speed control, in same currency as used in <i>parameter 23-81 Energy Cost</i> .

23-83 Energy Savings		
Range:		Function:
0 kWh*	[0 - 0 kWh]	This parameter allows a readout of the accumulated difference between the reference power and the actual output power. If motor size is set in hp (<i>parameter 1-21 Motor Power [HP]</i>), the equivalent kW value is used for the energy savings.

23-84 Cost Savings		
Range:		Function:
0*	[0 - 2147483647]	This parameter allows a readout of the calculation based on the above equation (in local currency).

23-85 CO2 Conversion Factor		
Range:		Function:
500 g*	[0 - 1000 g]	Enter the CO2 emission in grams per 1 kWh of electrical energy produced. Typical life-cycle greenhouse-gas emission values for different power sources are: <ul style="list-style-type: none"> • Renewable: 25 g. • Nuclear: 70 g. • Natural gas: 350 g. • Oil: 800 g. • Coal: 1000 g. For more precise emission values in your region, contact your regional environment agency.

23-86 CO2 Reduction		
Range:		Function:
0 kg*	[0 - 0 kg]	Shows the CO2 depletion in kg based on the CO2 conversion factor (<i>parameter 23-85 CO2 Conversion Factor</i>) and saved energy (<i>parameter 23-83 Energy Savings</i>).

3.21 Parameters 24-** Application Functions 2

3.21.1 24-0* Emergency Mode

CAUTION

Note that the frequency converter is only 1 component of the system. Correct function of emergency mode depends on the correct design and selection of system components. Ventilation systems working in life safety applications must be approved by the local emergency authorities. Non-interruption of the frequency converter due to emergency mode operation could cause overpressure and damage the system and components, including dampers and air ducts. The frequency converter itself could be damaged and become a source of danger. Danfoss accepts no responsibility for errors, malfunctions personal injury, or any damage to the frequency converter itself or components herein, pump systems and components herein, or other property when the frequency converter has been programmed for emergency mode. In no event shall Danfoss be liable to the end user or any other party for any direct or indirect, special, or consequential damage or loss suffered by such party, which has occurred due to the frequency converter being programmed and operated in emergency mode.

Background

Emergency mode is for use in critical situations, where it is imperative for the motor to keep running, regardless of the frequency converter's normal protective functions. Some selections of the emergency mode function cause alarms and trip conditions to be disregarded, enabling the motor to run without interruption.

Activation

Emergency mode is activated only via digital input terminals. See parameter group 5-1* *Digital Inputs*.

Messages in display

When emergency mode is activated, the display shows a status message *Emergency Mode* and a warning *Emergency Mode*. Once the emergency mode is again deactivated, the status messages disappear and the warning is replaced by the warning *Emergency M Was Active*. This message can only be reset by power-cycling the frequency converter supply. If a warranty-affecting alarm (see parameter 24-09 *Emergency Mode Alarm Handling*) should occur while the frequency converter is active in emergency mode, the display shows the warning *Emergency M Limits Exceeded*.

Digital and relay outputs can be configured for the status messages *Emergency Mode Active* and the warning *Emergency M Was Active*. See parameter group 5-3* *Digital Outputs* and parameter group 5-4* *Relays*.

Emergency M was Active messages can also be accessed in the warning word via serial communication. (See relevant documentation).

Access the status messages *Emergency Mode* via the extended status word.

Message	Type	LCP	Messages in display	Warning word 2	Ext. status word 2
Emergency Mode	Status	+	+	-	+ (bit 25)
Emergency Mode	Warning	+	-	-	-
Emergency M was Active	Warning	+	+	+ (bit 3)	-
Emergency M Limits Exceeded	Warning	+	+	-	-

Table 3.32 Messages in Display

Log

To see an overview of emergency mode-related events, view the emergency mode log, parameter group 18-1* *Emergency mode log*, or press [Alarm Log] on the LCP.

The log includes up to 10 of the latest events. Warranty-affecting alarms have a higher priority than the other 2 types of events.

The log cannot be reset.

The following events are logged:

- Warranty-affecting alarms (see parameter 24-09 *Emergency Mode Alarm Handling*).
- Emergency mode activated.

- Emergency mode deactivated.

All other alarms occurring while emergency mode is activated are logged as usual.

NOTICE!

During emergency mode operation, all stop commands to the frequency converter are ignored, including coast/coast inverse and external interlock. However, if Safe Torque Off is available in the frequency converter, this function is still active.

NOTICE!

If using the live zero function in emergency mode, then it is also active for analog inputs other than that used for emergency mode setpoint/feedback. Should the feedback to any of those other analog inputs be lost, for example a cable is burned, live zero function operates. If this is not wanted, disable the live zero function for those other inputs. Set the wanted live zero function if there is a missing signal when emergency mode is active in *parameter 6-02 Emergency Mode Live Zero Timeout Function*.

Warning for live zero has a higher priority than the warning *Emergency Mode*.

NOTICE!

If setting the command [11] *Start Reversing* on a digital input terminal in *parameter 5-10 Terminal 18 Digital Input*, the frequency converter interprets this as a reversing command.

24-00 Emergency Mode Function		
Option:	Function:	
		NOTICE! In the above, alarms are produced or ignored in accordance with the selection in <i>parameter 24-09 Emergency Mode Alarm Handling</i> .
[0]	Disabled	Emergency mode function is not active.
[1]	Enabled-Run Forward	In this mode, the motor continues to operate in a clockwise direction. Works only in open loop. Set <i>parameter 24-01 Emergency Mode Configuration</i> to [0] <i>Open Loop</i> .
[2]	Enabled-Run Reverse	In this mode, the motor continues to operate in a counterclockwise direction. Works only in open loop. Set <i>parameter 24-01 Emergency Mode Configuration</i> to [0] <i>Open Loop</i> .
[3]	Enabled-Coast	In this mode, the output is disabled and the motor is allowed to coast to stop.
[4]	Enabled-Run Fwd/Rev	

24-01 Emergency Mode Configuration		
Option:	Function:	
		NOTICE! Before adjusting the PID controller, set <i>parameter 24-09 Emergency Mode Alarm Handling</i> , [2] <i>Trip, All Alarms/Test</i> .
		NOTICE! If [2] <i>Enable-Run Reverse</i> is selected in <i>parameter 24-00 Emergency Mode Function</i> , [3] <i>Closed Loop</i> cannot be selected in <i>parameter 24-01 Emergency Mode Configuration</i> .
[0]	Open Loop	When emergency mode is active, the motor runs with a fixed speed based on a reference set. The unit is the same as selected in <i>parameter 0-02 Motor Speed Unit</i> .
[3]	Closed Loop	When emergency mode is active, the built-in PID controller controls the speed based on the setpoint and a feedback signal selected in <i>parameter 24-07 Emergency Mode Feedback Source</i> . Select the unit in <i>parameter 24-02 Emergency Mode Unit</i> . For other PID controller settings, use <i>parameter group 20-.** FC Closed Loop</i> as for normal operation. If the motor also is controlled by the built-in PID controller when in normal operation, the same transmitter can be used for both cases by selecting the same source.

24-02 Emergency Mode Unit		
Option:	Function:	
		Select the unit when emergency mode is active and running in closed loop.
[0]		
[1]	%	
[2]	RPM	
[3]	Hz	
[4]	Nm	
[5]	PPM	
[10]	1/min	
[11]	RPM	
[12]	Pulse/s	
[20]	l/s	
[21]	l/min	
[22]	l/h	
[23]	m ³ /s	
[24]	m ³ /min	
[25]	m ³ /h	
[30]	kg/s	
[31]	kg/min	
[32]	kg/h	
[33]	t/min	
[34]	t/h	
[40]	m/s	
[41]	m/min	
[45]	m	
[60]	°C	
[70]	mbar	
[71]	bar	
[72]	Pa	
[73]	kPa	
[74]	m WG	
[75]	mm Hg	
[80]	kW	
[120]	GPM	
[121]	gal/s	
[122]	gal/min	
[123]	gal/h	
[124]	CFM	
[125]	ft ³ /s	
[126]	ft ³ /min	
[127]	ft ³ /h	
[130]	lb/s	
[131]	lb/min	
[132]	lb/h	
[140]	ft/s	
[141]	ft/min	
[145]	ft	
[160]	°F	
[170]	psi	

24-02 Emergency Mode Unit		
Option:	Function:	
[171]	lb/in ²	
[172]	in WG	
[173]	ft WG	
[174]	in Hg	
[180]	HP	

24-03 Emergency Mode Min Reference		
Range:	Function:	
Size related*	[-999999.999 - par. 24-04 FireModeUnit]	Minimum value for the reference/setpoint (limiting the sum of value in <i>parameter 24-05 Emergency Mode Preset Reference</i> and value of signal on input selected in <i>parameter 24-06 Emergency Mode Reference Source</i>). If running in open loop when emergency mode is active, the unit is selected by the setting of <i>parameter 0-02 Motor Speed Unit</i> . For closed loop, select the unit in <i>parameter 24-02 Emergency Mode Unit</i> .

24-04 Emergency Mode Max Reference		
Range:	Function:	
Size related*	[par. 24-03 - 999999.999 FireModeUnit]	Maximum value for the reference/setpoint (limiting the sum of value in <i>parameter 24-05 Emergency Mode Preset Reference</i> and value of signal on input selected in <i>parameter 24-06 Emergency Mode Reference Source</i>). If running in open loop when emergency mode is active, the unit is selected by the setting of <i>parameter 0-02 Motor Speed Unit</i> . For closed loop, select the unit in <i>parameter 24-02 Emergency Mode Unit</i> .

24-05 Emergency Mode Preset Reference		
Range:	Function:	
0 %*	[-100 - 100 %]	Enter the required preset reference/setpoint as a percentage of the value in <i>parameter 24-04 Emergency Mode Max Reference</i> . The set value is added to the value represented by the signal on the analog input selected in <i>parameter 24-06 Emergency Mode Reference Source</i> .

24-06 Emergency Mode Reference Source		
Option:	Function:	
		Select the external reference input to be used for the emergency mode. This signal is added to the value set in <i>parameter 24-06 Emergency Mode Reference Source</i> .
[0] *	No function	
[1]	Analog Input 53	
[2]	Analog Input 54	
[7]	Pulse input 29	
[8]	Pulse input 33	
[20]	Digital pot.meter	
[21]	Analog input X30/11	
[22]	Analog input X30/12	
[23]	Analog Input X42/1	
[24]	Analog Input X42/3	
[25]	Analog Input X42/5	
[29]	Analog Input X48/2	
[33]	PCD Bus Reference	

24-07 Emergency Mode Feedback Source		
Option:	Function:	
		Select the feedback input to be used for the emergency mode feedback signal when emergency mode is active. If the motor is also controlled by the built-in PID controller when in normal operation, the same transmitter can be used for both cases by selecting the same source.
[0] *	No function	
[1]	Analog Input 53	
[2]	Analog Input 54	
[3]	Pulse input 29	
[4]	Pulse input 33	
[7]	Analog Input X30/11	
[8]	Analog Input X30/12	
[9]	Analog Input X42/1	
[10]	Analog Input X42/3	
[11]	Analog Input X42/5	
[99]	Normal Feedback	
[100]	Bus Feedback 1	
[101]	Bus Feedback 2	
[102]	Bus feedback 3	

24-09 Emergency Mode Alarm Handling		
Option:	Function:	
[0]	Trip+Reset, Critical Alarms	If this mode is selected, the frequency converter continues to run, ignoring most alarms, even if doing so may result in damage of the frequency converter. Critical alarms are alarms which cannot be suppressed, but a restart attempt is possible (infinity automatic reset).
[1] *	Trip, Critical Alarms	If there is a critical alarm, the frequency converter trips and does not auto restart (manual reset).
[2]	Trip, All Alarms/Test	It is possible to test the operation of emergency mode, but all alarm states are activated normally (manual reset).

NOTICE!

Certain alarms are warranty-affecting alarms that can affect the lifetime of the frequency converter. Should 1 of these ignored alarms occur while in emergency mode, a log of the event is stored in the emergency mode log. Here the 10 latest events of warranty-affecting alarms, emergency mode activation, and emergency mode deactivation are stored.

NOTICE!

The setting in *parameter 14-20 Reset Mode* is disregarded if emergency mode is active (see parameter group 24-0* *Emergency Mode*).

Number	Description	Critical alarms	Warranty-affecting alarms
4	Mains ph. Loss		x
7	DC overvolt	x	
8	DC undervolt	x	
9	Inverter overloaded		x
13	Over current	x	
14	Earth (ground) fault	x	
16	Short circuit	x	
29	Power card temp		x
33	Inrush fault		x
38	Internal fault		x
65	Ctrl. card temp		x
68	Safe Stop	x	

Table 3.33 Emergency Mode Alarm Handling

3.21.2 24-1* Drive Bypass

Function for activation of external contactors to bypass the frequency converter for direct online operation of the motor, if there is a trip.

24-10 Drive Bypass Function		
Option:	Function:	
		<p>NOTICE!</p> <p>After enabling the frequency converter bypass function, the Safe Torque Off function (in versions, where included) does not comply with standard EN 954-1, Cat. 3 installations.</p> <p>This parameter determines the circumstances that activate the frequency converter bypass function.</p>
[0] *	Disabled	
[1]	Enabled	<p>If in normal operation, the automatic frequency converter bypass function is activated under the following conditions:</p> <ul style="list-style-type: none"> • If there is a trip lock or a trip. • After the programmed number of reset attempts programmed in <i>parameter 14-20 Reset Mode</i>. • If the bypass delay timer (<i>parameter 24-11 Drive Bypass Delay Time</i>) expires before reset attempts have been completed.
[2]	Enabled (Emergency M Only)	

24-11 Drive Bypass Delay Time		
Range:	Function:	
0 s*	[0 - 600 s]	<p>Programmable in 1 s increments. Once the bypass function is activated in accordance with the setting in <i>parameter 24-10 Drive Bypass Function</i>, the bypass delay timer begins to operate. If the frequency converter has been set for several restart attempts, the timer continues to run while the frequency converter tries to restart. Should the motor have restarted within the time period of the bypass delay timer, the timer is reset.</p> <p>Should the motor fail to restart at the end of the bypass delay time, the frequency converter bypass relay is activated, which has been programmed for bypass in <i>parameter 5-40 Function Relay</i>. If a relay delay has also been programmed in <i>parameter 5-41 On Delay, Relay, [Relay]</i> or <i>parameter 5-42 Off Delay, Relay, [Relay]</i>, this time must also elapse before the relay action is performed.</p> <p>Where no restart attempts are programmed, the timer runs for the delay period set in this parameter and activates the frequency converter bypass relay, which has been programmed for bypass in <i>parameter 5-40 Function Relay</i>. If a relay delay has also been programmed in <i>parameter 5-41 On Delay, Relay</i> or <i>parameter 5-42 Off Delay, Relay, [Relay]</i>, this time must also elapse before the relay action is performed.</p>

3.22 Parameters 25-** Cascade Controller

Parameters for configuring the basic cascade controller for sequence control of multiple pumps. For a more application-oriented description and wiring examples, see *Application Examples, Cascade Controller* in the *design guide*.

For information on using the advanced features of the cascade controller options, see *chapter 3.24 Parameters 27-** Cascade CTL Option*.

To configure the cascade controller to the actual system and the required control strategy, follow the sequence starting with *parameter group 25-0* System Settings* and next *parameter group 25-5* Alternation Settings*. These parameters can normally be set in advance.

Parameters in *parameter groups 25-2* Bandwidth Settings* and *25-4* Staging Settings* often depend on the dynamic of the system and final adjustment to be done at the commissioning of the plant.

NOTICE!

The cascade controller is supposed to operate in closed loop controlled by the built-in PI controller ([3] *closed loop* selected in *parameter 1-00 Configuration Mode*). If [0] *open loop* is selected in *parameter 1-00 Configuration Mode*, all fixed speed pumps are destaged, but the variable speed pump is still controlled by the frequency converter, now as an open-loop configuration:

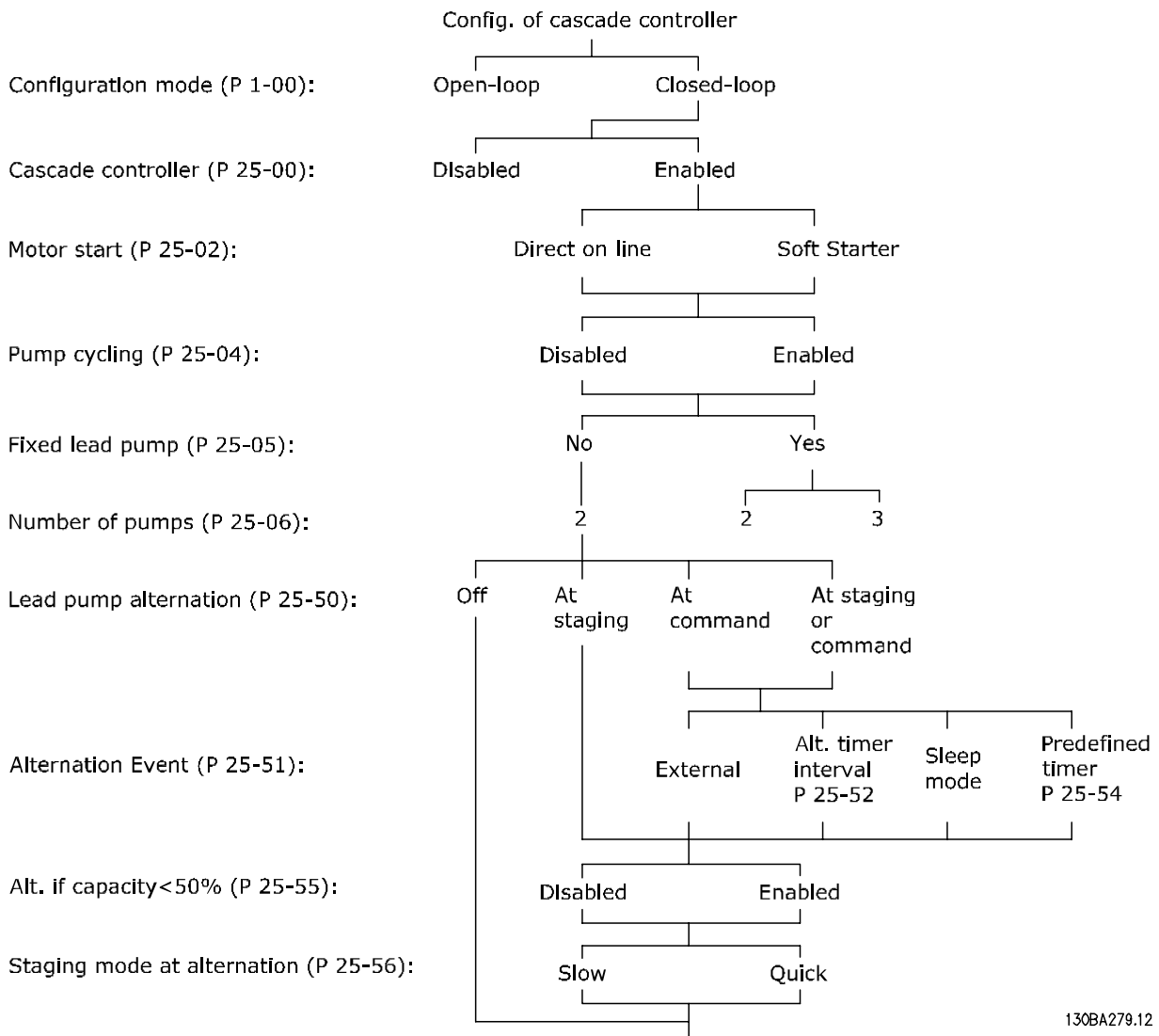

Figure 3.79 Cascade Controller Sample Set-up

3.22.1 25-0* System Settings

Parameters related to control principles and configuration of the system.

25-00 Cascade Controller		
Option:	Function:	
		For operation of multiple devices (pump/fan) systems where capacity is adapted to actual load with speed control combined with on/off control of the devices. For simplicity, only pump systems are described. To enable the cascade controller functionality, set <i>parameter 1-00 Configuration Mode</i> to option [3] <i>Closed Loop</i> .
[0]	Disabled	The cascade controller is not active. All built-in relays assigned to pump motors in the cascade function are de-energized. If a variable speed pump is connected to the frequency converter directly (not controlled by a built-in relay), this pump/fan is controlled as a single-pump system.
[1]	Basic Cascade Ctrl	The cascade controller is active and stages/destages pump according to load on the system.
[2]	Motor Alternation Only	

25-02 Motor Start		
Option:	Function:	
		Motors are connected to mains directly with a contactor or with a soft starter. When the value of <i>parameter 25-02 Motor Start</i> is set to an option other than [0] <i>Direct on Line</i> , then <i>parameter 25-50 Lead Pump Alternation</i> is automatically set to the default of [0] <i>Direct on Line</i> .
[0]	Direct on Line *	Each fixed speed pump is connected to mains directly via a contactor.
[1]	Soft Starter	Each fixed speed pump is connected to mains via a soft starter.
[2]	Star Delta	Fixed pumps connected with star-delta starters are staged in the same way as pumps connected with soft starters. They are destaged in the same way as pumps connected directly to mains.

25-04 Pump Cycling		
Option:	Function:	
		To provide equal hours of operation with fixed speed pumps, the pump used can be cycled. The

25-04 Pump Cycling		
Option:	Function:	
		selection of pump cycling is either <i>first in – last out</i> or equal running hours for each pump.
[0]	Disabled	The fixed speed pumps are connected in the order 1–2 and disconnected in the order 2–1 (first in–last out).
[1]	Enabled	The fixed speed pumps are connected/disconnected to have equal running hours for each pump.

25-05 Fixed Lead Pump		
Option:	Function:	
		Fixed lead pump is a configuration when the variable speed pump is connected directly to the frequency converter. If a contactor is applied between frequency converter and pump, this contactor is not controlled by the frequency converter. If operating with <i>parameter 25-50 Lead Pump Alternation</i> set to other than [0] <i>Off</i> , set this parameter to [0] <i>No</i> .
[0]	No	The lead pump function can alternate between the pumps controlled by the 2 built-in relays. Connect 1 pump to the built-in relay 1, and the other pump to relay 2. The pump function (cascade pump1 and cascade pump2) is automatically assigned to the relays (maximum 2 pumps can in this case be controlled by the frequency converter).
[1]	Yes	The lead pump is fixed (no alternation) and connected directly to the frequency converter. <i>Parameter 25-50 Lead Pump Alternation</i> is automatically set to [0] <i>Off</i> . Built-in relays, relay 1 and relay 2, can be assigned to separate fixed speed pumps. In total, the frequency converter can control 3 pumps.

25-06 Number of Pumps		
Range:	Function:	
2* [2 - 9]	<p>The number of pumps connected to the cascade controller including the variable speed pump. If the variable speed pump is connected directly to the frequency converter, and the other fixed speed pumps (lag pumps) are controlled by the 2 built-in relays, 3 pumps can be controlled. If both the variable speed and fixed speed pumps are to be controlled by built-in relays, only 2 pumps can be connected.</p> <p>If <i>parameter 25-05 Fixed Lead Pump</i> is set to [0] No: 1 variable speed pump and 1 fixed speed pump, both controlled by built-in relay. If <i>parameter 25-05 Fixed Lead Pump</i> is set to [1] Yes: 1 variable speed pump and 1 fixed speed pump controlled by built-in relays.</p> <p>1 lead pump, see <i>parameter 25-05 Fixed Lead Pump</i>. 2 fixed speed pumps controlled by built-in relays.</p>	

3.22.2 25-2* Bandwidth Settings

Parameters for setting the bandwidth within which the pressure is allowed to operate before staging/destaging fixed speed pumps. Also includes various timers to stabilize the control.

25-20 Staging Bandwidth		
Range:	Function:	
Size related* [1 - par. 25-21 %]	<p>Set the staging bandwidth (SBW) percentage to accommodate normal system pressure fluctuation. In cascade control systems, to avoid frequent switching of fixed speed pumps, the system pressure is typically kept within a bandwidth rather than at a constant level.</p> <p>The SBW is programmed as a percentage of <i>parameter 3-03 Maximum Reference</i>. For example, if the maximum reference is 6 bar, the setpoint is 5 bar and the SBW is set to 10%, a system pressure between 4.5 bar and 5.5 bar is tolerated. No staging or destaging occurs within this bandwidth.</p>	

25-20 Staging Bandwidth		
Range:	Function:	
	<p>Figure 3.80 Staging Bandwidth</p>	
Size related* [1 - par. 25-21 %]	<p>Set the staging bandwidth (SBW) percentage to accommodate normal system pressure fluctuation. In cascade control systems, to avoid frequent switching of fixed speed pumps, the system pressure is typically kept within a bandwidth rather than at a constant level.</p> <p>The SBW is programmed as a percentage of <i>parameter 3-03 Maximum Reference</i> and <i>parameter 3-04 Reference Function</i>. For example, if the setpoint is 5 bar and the SBW is set to 10%, a system pressure of 4.5–5.5 bar is tolerated. No staging or destaging occurs within this bandwidth.</p> <p>Figure 3.81 Staging Bandwidth</p>	

25-21 Override Bandwidth		
Range:	Function:	
100 %* [par. 25-20 - 100 %]	<p>When a large and quick change in the system demand occurs (such as a sudden water demand), the system pressure rapidly changes and an immediate staging or destaging of a fixed speed pump becomes necessary to match the requirement. The override bandwidth (OBW) is programmed to override the staging/destaging timer (<i>parameter 25-23 SBW Staging Delay</i> and <i>parameter 25-24 SBW Destaging Delay</i>) for immediate response.</p> <p>Always program the OBW to a higher value than the value set in <i>parameter 25-20 Staging Bandwidth</i>. The OBW is a percentage of</p>	

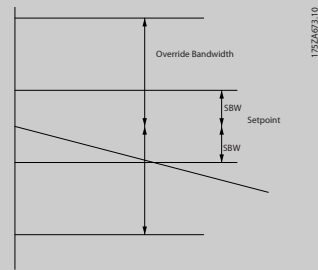
25-21 Override Bandwidth	
Range:	Function:
	<p>parameter 3-02 Minimum Reference and parameter 3-03 Maximum Reference.</p>  <p>Figure 3.83</p> <p>Setting the OBW too close to the SBW could defeat the purpose with frequent staging at momentary pressure changes. Setting the OBW too high might lead to unacceptably high or low pressure in the system while the SBW timers are running. The value can be optimized with increased familiarity with the system. See parameter 25-25 OBW Time.</p> <p>To avoid unintended staging during the commissioning phase and fine-tuning of the controller, initially leave the OBW at the factory setting of 100% (Off). When the fine-tuning is completed, set the OBW to the required value. Initial value of 10% is suggested.</p>

25-22 Fixed Speed Bandwidth	
Range:	Function:
Size related*	<p>[par. 25-20 - par. 25-21 %]</p> <p>When the cascade control system runs normally and the frequency converter issues a trip alarm, it is important to maintain the system head. The cascade controller does this by continuing to stage/destage the fixed speed pump on and off. As keeping the head at the setpoint would require frequent staging and destaging when only a fixed speed pump is running, a wider fixed speed bandwidth (FSBW) is used instead of SBW. In alarm situations, or if the start signal on the digital input goes low, it is possible to stop the fixed speed pumps by pressing [Off] or [Hand On].</p> <p>If the issued alarm is a trip lock alarm, the cascade controller stops the system immediately by cutting out all the fixed speed pumps. This is basically the same as</p>

25-22 Fixed Speed Bandwidth	
Range:	Function:
	emergency stop (coast/coast inverse command) for the cascade controller.

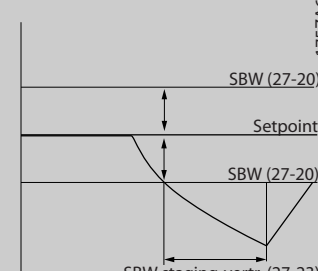
25-23 SBW Staging Delay	
Range:	Function:
15 s*	<p>[0 - 3000 s]</p> <p>Immediate staging of a fixed speed pump is not desirable when a momentary pressure drop in the system exceeds the staging bandwidth (SBW). Staging is delayed by the length of time programmed. If the pressure increases within the SBW before the timer has elapsed, the timer is reset.</p>  <p>Figure 3.84 SBW Staging Delay</p>

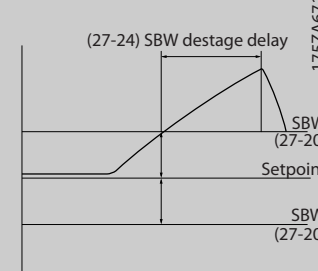
25-24 SBW Destaging Delay	
Range:	Function:
15 s*	<p>[0 - 3000 s]</p> <p>Immediate destaging of a fixed speed pump is not recommended when a momentary pressure increases in the system that exceeds the staging bandwidth (SBW). Destaging is delayed by the length of time programmed. If the pressure decreases within the SBW before the timer has elapsed, the timer is reset.</p>  <p>Figure 3.85 SBW Destaging Delay</p>

25-25 OBW Time		
Range:	Function:	
10 s*	[0 - 300 s]	Staging a fixed speed pump creates a momentary pressure peak in the system, which might exceed the override bandwidth (OBW). It is not recommended to destage a pump in response to a staging pressure peak. The OBW time can be programmed to prevent staging until the system pressure has stabilized and normal control established. Set the timer to a value that allows the system to stabilize after staging. The 10 s factory setting is appropriate in most applications. In highly dynamic systems, a shorter time may be wanted.

25-28 Stage Function Time		
Range:	Function:	
15 s*	[0 - 300 s]	The stage function time is programmed to avoid frequent staging of the fixed speed pumps. The stage function time starts if it is [1] Enabled by parameter 25-27 Stage Function, and when the variable speed pump runs at motor speed high limit, parameter 4-13 Motor Speed High Limit [RPM] or parameter 4-14 Motor Speed High Limit [Hz], with at least 1 fixed speed pump in the stop position. When the programmed value of the timer expires, a fixed speed pump is staged.

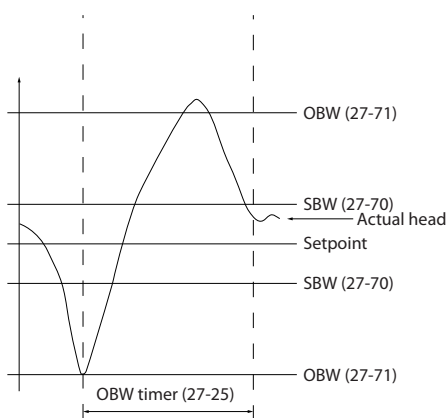

130BA370.11

Figure 3.86 OBW Time

25-29 Destage Function		
Option:	Function:	
		The destage function ensures that the lowest numbers of pumps are running to save energy and to avoid dead head water circulation in the variable speed pump. If the destage function is set to [0] Disabled, parameter 25-30 Destage Function Time is not activated.
[0]	Disabled	
[1]	Enabled	

25-26 Destage At No-Flow		
Option:	Function:	
		This parameter ensures that when a no-flow situation occurs, the fixed speed pumps are destaged 1 by 1 until the no-flow signal disappears. This requires that no-flow detection is active. See parameter group 22-2* No-Flow Detection. If [0] Disabled is selected, the cascade controller does not change the normal behavior of the system.
[0]	Disabled	
[1]	Enabled	

25-30 Destage Function Time		
Range:	Function:	
15 s*	[0 - 300 s]	The destage function timer is programmable to avoid frequent staging/destaging of the fixed speed pumps. The destage function time starts when the adjustable speed pump is running at parameter 4-11 Motor Speed Low Limit [RPM] or parameter 4-12 Motor Speed Low Limit [Hz], with 1 or more fixed speed pumps in operation and system requirements satisfied. In this situation, the adjustable speed pump contributes a little to the system. When the programmed value of the timer expires, a stage is removed, avoiding dead head water circulation in the adjustable speed pump.

25-27 Stage Function		
Option:	Function:	
		If the stage function is set to [0] Disabled, parameter 25-28 Stage Function Time is not activated.
[0]	Disabled	
[1]	Enabled	

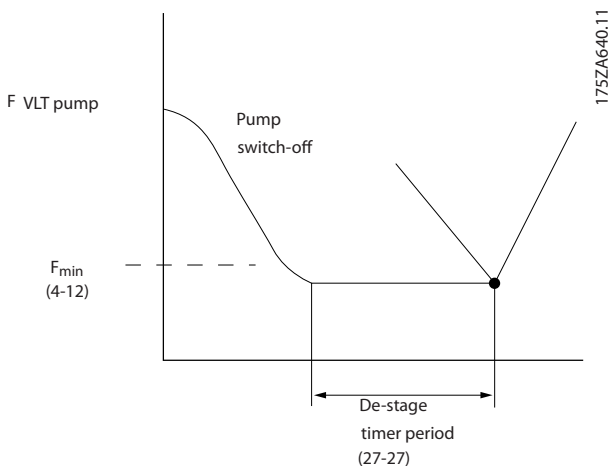

Figure 3.87 Destage Function Time

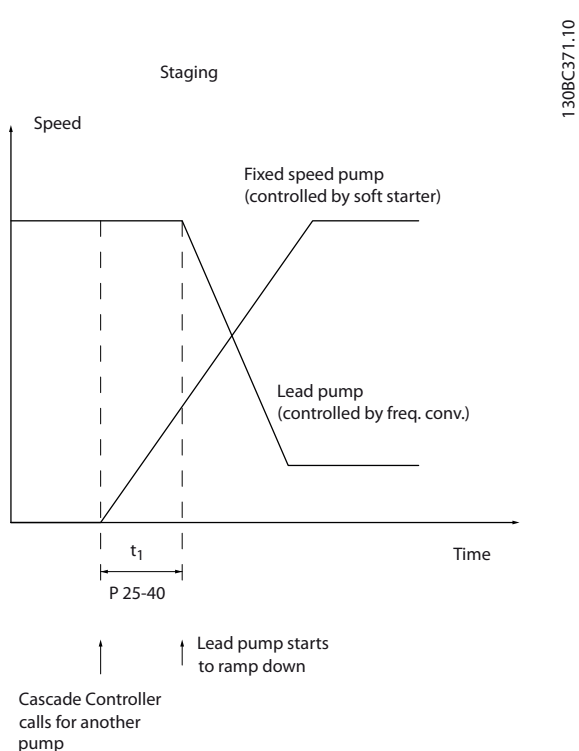

Figure 3.88 Staging

3.22.3 25-4* Staging Settings

Parameters determining conditions for staging/destaging the pumps.

25-40 Ramp Down Delay		
Range:	Function:	
10 s* [0 - 120 s]	When adding a fixed speed pump controlled by a soft starter or a star-delta starter, it is possible to delay the ramp down of the lead pump until a preset time after the start of the fixed speed pump. This delay eliminates pressure surges or water hammer in the system. Use this option only if [1] Soft Starter or [2] Star Delta is selected in parameter 25-02 Motor Start.	

25-41 Ramp Up Delay		
Range:	Function:	
2 s* [0 - 12 s]	When removing a fixed speed pump controlled by a soft starter, it is possible to delay the ramp up of the lead pump until a preset time after the stop of the fixed speed pump. This delay eliminates pressure surges or water hammer in the system. Only to be used if [1] Soft Starter is selected in parameter 25-02 Motor Start.	

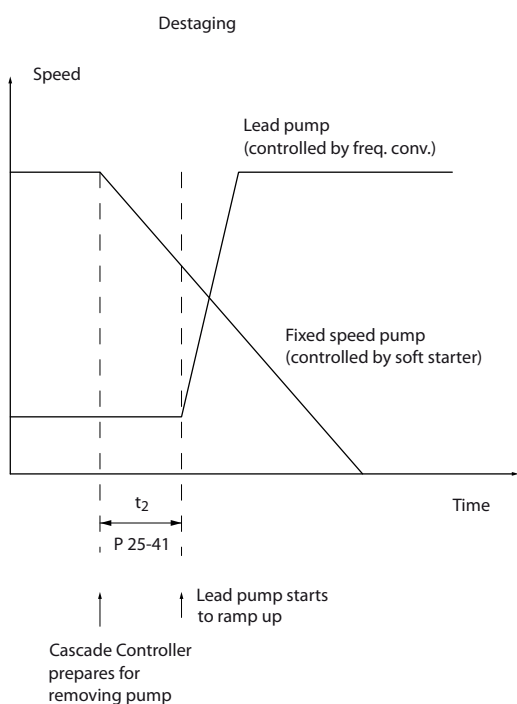

Figure 3.89 Destaging

NOTICE!

Fixed pumps connected with star-delta starters are staged in the same way as pumps connected with soft starters. They are destaged in the same way as pumps connected directly to mains.

25-42 Staging Threshold	
Range:	Function:
Size related* [0 - 100 %]	When adding a fixed speed pump to prevent an overshoot of pressure, the variable speed pump ramps down to a lower speed. When the variable speed pump reaches the staging speed, the fixed speed pump is staged on. The staging threshold is used to calculate the speed of the variable speed pump when the cut-in point of the fixed speed pump occurs. The calculation of the staging threshold is the ratio of <i>parameter 4-11 Motor Speed Low Limit [RPM]</i> or <i>parameter 4-12 Motor Speed Low Limit [Hz]</i> , to the <i>parameter 4-13 Motor Speed High Limit [RPM]</i> or <i>parameter 4-14 Motor Speed High Limit [Hz]</i> , expressed in percent. Staging threshold must range from $STAGE \% = \frac{LOW}{HIGH} \times 100 \%$

25-42 Staging Threshold	
Range:	Function:
	to 100%, where n _{LOW} is motor speed low limit and n _{HIGH} is motor speed high limit.

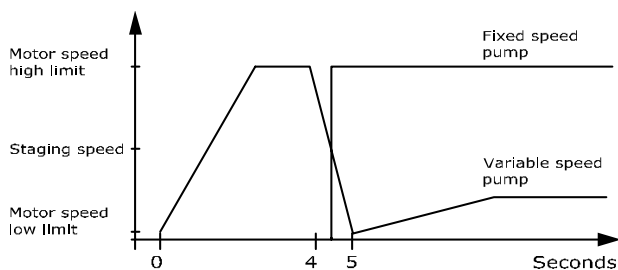

Figure 3.90 Staging Threshold

NOTICE!

If the setpoint is reached after staging before the variable speed pump reaches its minimum speed, the system enters the state closed loop when the feedback pressure is crossing the setpoint.

25-43 Destaging Threshold	
Range:	Function:
Size related* [0 - 100 %]	When removing a fixed speed pump to prevent an undershoot of pressure, the variable speed pump ramps up to a higher speed. When the variable speed pump reaches the destaging speed, the fixed speed pump is destaged. The destaging threshold is used to calculate the speed of the variable speed pump when the destaging of the fixed speed pump occurs. The calculation of the destaging threshold is the ratio of <i>parameter 4-11 Motor Speed Low Limit [RPM]</i> or <i>parameter 4-12 Motor Speed Low Limit [Hz]</i> , to <i>parameter 4-13 Motor Speed High Limit [RPM]</i> or <i>parameter 4-14 Motor Speed High Limit [Hz]</i> , expressed in percent. Destaging threshold must range from $STAGE \% = \frac{LOW}{HIGH} \times 100 \%$ to 100%, where n _{LOW} is motor speed low limit and n _{HIGH} is motor speed high limit.

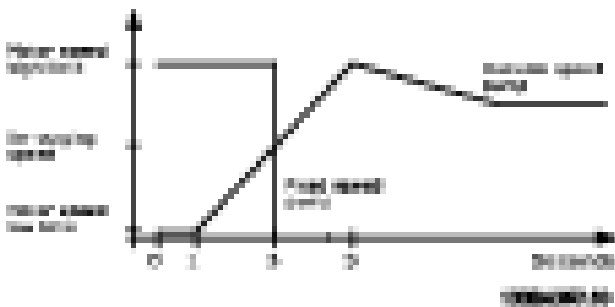

Figure 3.91 Destaging Threshold

25-44 Staging Speed [RPM]		
Range:	Function:	
0 RPM* [000 - 30000 RPM]	<p>Readout of the calculated value for staging speed. When adding a fixed speed pump to prevent an overshoot of pressure, the variable speed pump ramps down to a lower speed. When the variable speed pump reaches the staging speed, the fixed speed pump is staged on. Staging speed calculation is based on <i>parameter 25-42 Staging Threshold</i> and <i>parameter 4-13 Motor Speed High Limit [RPM]</i>.</p> <p>Staging speed is calculated with the following formula:</p> $n_{STAGE} = n_{HIGH} \frac{n_{STAGE\%}}{100}$ <p>where n_{HIGH} is motor speed high limit and $n_{STAGE100\%}$ is the value of staging threshold.</p>	

25-45 Staging Speed [Hz]		
Range:	Function:	
0 Hz* [0 - 6500 Hz]	<p>Readout of the calculated value for staging speed. When adding a fixed speed pump to prevent an overshoot of pressure, the variable speed pump ramps down to a lower speed. When the variable speed pump reaches the staging speed, the fixed speed pump is staged on. Staging speed calculation is based on <i>parameter 25-42 Staging Threshold</i> and <i>parameter 4-14 Motor Speed High Limit [Hz]</i>.</p> <p>Staging speed is calculated with the following formula:</p> $STAGE = HIGH \frac{STAGE\%}{100}$ <p>where n_{HIGH} is motor speed high limit and $n_{STAGE100\%}$ is the value of staging threshold.</p>	

25-46 Destaging Speed [RPM]		
Range:	Function:	
0 RPM* [000 - 30000 RPM]	<p>Readout of the calculated value for destaging speed. When removing a fixed speed pump to prevent an undershoot of pressure, the variable speed pump ramps up to a higher speed. When the variable speed pump reaches the destaging speed, the fixed speed pump is destaged. Destaging speed is calculated based on <i>parameter 25-43 Destaging Threshold</i> and <i>parameter 4-13 Motor Speed High Limit [RPM]</i>.</p> <p>Destaging speed is calculated with the following formula:</p> $DESTAGE = HIGH \frac{DESTAGE\%}{100}$ <p>where n_{HIGH} is motor speed high limit and $n_{DESTAGE100\%}$ is the value of destaging threshold.</p>	

25-47 Destaging Speed [Hz]		
Range:	Function:	
0 Hz* [0 - 6500 Hz]	<p>Readout of the calculated value for destaging speed. When removing a fixed speed pump to prevent an undershoot of pressure, the variable speed pump ramps up to a higher speed. When the variable speed pump reaches the destaging speed, the fixed speed pump is destaged. Destaging speed is calculated based on <i>parameter 25-43 Destaging Threshold</i> and <i>parameter 4-14 Motor Speed High Limit [Hz]</i>.</p> <p>Destaging speed is calculated with the following formula:</p> $DESTAGE = HIGH \frac{DESTAGE\%}{100}$ <p>where n_{HIGH} is motor speed high limit and $n_{DESTAGE100\%}$ is the value of destaging threshold.</p>	

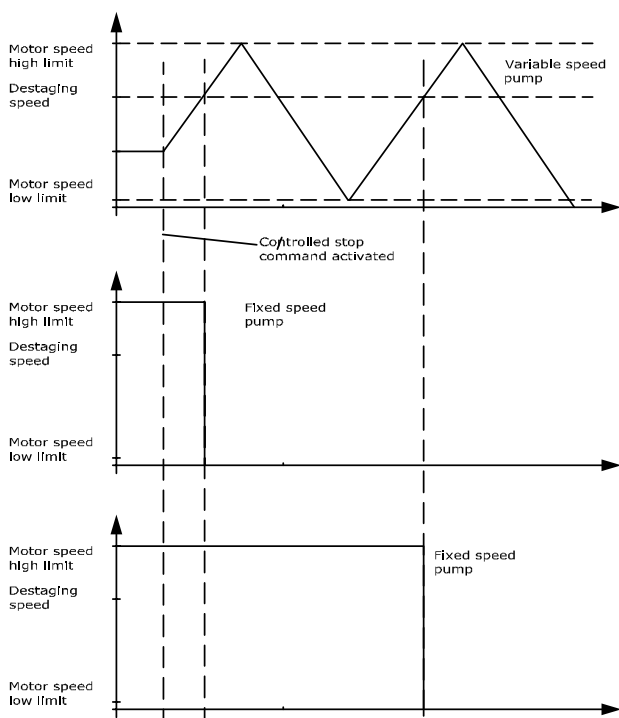

130BA368.10

Figure 3.92 Destaging Speed

25-49 Staging Principle		
Select the staging principle for the staging of fixed speed pumps (direct online mode). To configure the frequency converter to return to closed-loop operation immediately after a pump was staged or destaged, select [1] Rapid Staging. Use [1] Rapid Staging in systems with rapid demand changes.		
Option:	Function:	
[0] *	Normal	
[1]	Rapid Staging	

3.22.4 25-5* Alternation Settings

Parameters for defining the conditions for alternation of the variable speed pump (lead), if selected as control strategy.

25-50 Lead Pump Alternation		
Option:	Function:	
	NOTICE! If parameter 25-05 Fixed Lead Pump is set to [1] Yes, it is only possible to select [0] Off.	
	Lead pump alternation equalizes the use of pumps by periodically changing the pump that is speed-controlled. This ensures that pumps are	

25-50 Lead Pump Alternation		
Option:	Function:	
	equally used over time. Alternation equalizes the usage of pumps by always selecting the pump with the lowest number of hours run to stage on next.	
[0]	Off	No alternation of lead pump function takes place. It is not possible to set this parameter to options other than [0] Off if parameter 25-02 Motor Start is set other than [0] Direct on Line.
[1]	At staging	Alternation of the lead pump function takes place when staging another pump.
[2]	At command	Alternation of the lead pump function takes place at an external command signal or a pre-programmed event. See parameter 25-51 Alternation Event for available options.
[3]	At staging or command	Alternation of the variable speed (lead) pump takes place at staging or according to [2] At command.

25-51 Alternation Event		
Option:	Function:	
	This parameter is only active if the options [2] At Command or [3] At Staging or Command have been selected in parameter 25-50 Lead Pump Alternation. If an alternation event is selected, the alternation of lead pump takes place every time the event occurs.	
[0]	External *	Alternation takes place when a signal is applied to 1 of the digital inputs on the terminal strip and this input has been assigned to [121] Lead Pump Alternation in parameter group 5-1*, Digital Inputs.
[1]	Alternation Time Interval	Alternation takes place every time parameter 25-52 Alternation Time Interval expires.
[2]	Sleep Mode	Alternation takes place each time the lead pump goes into sleep mode. Set parameter 20-23 Setpoint 3 to [1] Sleep Mode or apply an external signal for this function.
[3]	Predefined Time	Alternation takes place at a defined time of the day. If parameter 25-54 Alternation Predefined Time is set, the alternation is carried out every day at the specified time. Default time is midnight (00:00 or 12:00AM depending on the time format).

25-52 Alternation Time Interval		
Range:	Function:	
24 h*	[1 - 999 h]	If selecting [1] <i>Alternation Time Interval</i> in <i>parameter 25-51 Alternation Event</i> , the alternation of the variable speed pump takes place every time the alternation time interval expires (can be checked in <i>parameter 25-53 Alternation Timer Value</i>). The timer pauses when the frequency converter is not running.

25-53 Alternation Timer Value		
Range:	Function:	
0*	[0 - 7]	Readout parameter for the alternation time interval value set in <i>parameter 25-52 Alternation Time Interval</i> .

25-54 Alternation Predefined Time		
Range:	Function:	
Size related*	[0 - 0]	If selecting [3] <i>Predefined Time</i> in <i>parameter 25-51 Alternation Event</i> , the variable speed pump alternation is carried out every day at the specified time set in alternation predefined time. Default time is midnight (00:00 or 12:00AM depending on the time format).

25-55 Alternate if Load < 50%		
Option:	Function:	
		<p>NOTICE!</p> <p>Only valid if <i>parameter 25-50 Lead Pump Alternation</i> is different from [0] <i>Off</i>.</p> <p>If selecting [1] <i>Enabled</i>, the pump alternation can only occur if the capacity is equal to or below 50%. The capacity calculation is the ratio of running pumps (including the variable speed pump) to the total number of available pumps (including variable speed pump, but not those that are interlocked).</p> $Capacity = \frac{N_{RUNNING}}{N_{TOTAL}} \times 100\%$ <p>For the basic cascade controller, all pumps are of equal size.</p>
[0]	Disabled	The lead pump alternation takes place at any pump capacity.
[1] *	Enabled	The lead pump function is alternated only if the number of pumps running are providing less than 50% of total pump capacity.

25-56 Staging Mode at Alternation		
Option:	Function:	
[0] *	Slow	<p>This parameter is only active if the option selected in <i>parameter 25-50 Lead Pump Alternation</i> is different from [0] <i>Off</i>.</p> <p>2 types of staging and destaging of pumps are possible. Slow transfer makes staging and destaging smooth. Quick transfer makes staging and destaging as fast as possible; the variable speed pump is cut out (coasted).</p> <p>At alternation, the variable speed pump is ramped up to maximum speed and then ramped down to a standstill.</p>
[1]	Quick	<p>At alternation, the variable speed pump is ramped up to maximum speed and then coasted to a standstill.</p> <p><i>Figure 3.93</i> and <i>Figure 3.94</i> show alternation in both quick and slow configurations.</p>

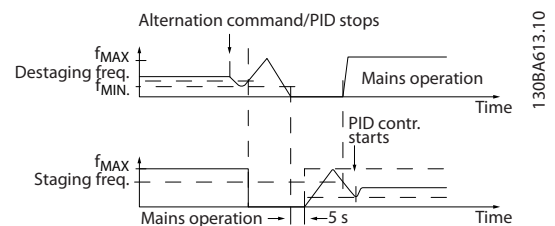

Figure 3.93 Slow Configuration

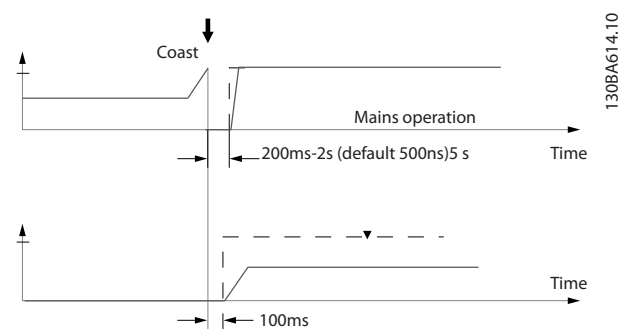

Figure 3.94 Quick Configuration

25-58 Run Next Pump Delay		
Range:	Function:	
0.1 s* [0.1 - 5 s]	This parameter is only active if the option selected in <i>parameter 25-50 Lead Pump Alternation</i> is different from [0] Off. This parameter sets the time between stopping the old variable speed pump and starting another pump as a new variable speed pump. Refer to <i>parameter 25-56 Staging Mode at Alternation</i> for description of staging and alternation.	

25-59 Run on Mains Delay		
Range:	Function:	
0.5 s* [par. 25-58 - 5 s]	This parameter is only active if the option selected in <i>parameter 25-50 Lead Pump Alternation</i> is different from [0] Off. This parameter sets the time between stopping the old variable speed pump and starting this pump as a new fixed speed pump. Refer to <i>Figure 3.93</i> for description of staging and alternation.	

3.22.5 25-8* Status

Readout parameters informing about the operating status of the cascade controller and the pumps controlled.

25-80 Cascade Status		
Range:	Function:	
0* [0 - 25]	Readout of the status of the cascade controller.	

25-81 Pump Status		
Range:	Function:	
0* [0 - 25]	Pump status shows the status for the number of pumps selected in <i>parameter 25-06 Number of Pumps</i> . It is a readout of the status for each of the pumps showing a string, which consists of pump number and the status of the pump. Example: Readout is with the abbreviation like "1:D 2:O" This means that pump 1 is running and speed controlled by the frequency converter and pump 2 is stopped.	

25-82 Lead Pump		
Range:	Function:	
0* [0 - par. 25-06]	Readout parameter for the actual variable speed pump in the system. The lead pump parameter is updated to reflect the current variable speed pump in the system when an alternation takes place. If no lead pump is selected (cascade	

25-82 Lead Pump		
Range:	Function:	
	controller disabled or all pumps interlocked), the display shows N1.	

25-83 Relay Status		
Array [9]		
Range:	Function:	
0* [0 - 4]	Readout of the status for each of the relays assigned to control the pumps. Every element in the array shows a relay. If a relay is activated, the corresponding element is set to On. If a relay is deactivated, the corresponding element is set to Off.	

25-84 Pump ON Time		
Array [10]		
Range:	Function:	
0 h* [0 - 2147483647 h]	Readout of the value for pump ON time. The cascade controller has separate counters for the pumps and for the relays that control the pumps. Pump ON time monitors the operating hours of each pump. The value of each pump ON time counter can be reset to 0 by writing in the parameter, for example, if the pump is replaced at a service.	

25-85 Relay ON Time		
Array [9]		
Range:	Function:	
0 h* [0 - 2147483647 h]	Readout of the value for relay ON time. The cascade controller has separate counters for the pumps and for the relays that control the pumps. Pump cycling is always done based on the relay counters, otherwise it would always use the new pump if a pump is replaced and its value in <i>parameter 25-84 Pump ON Time</i> is reset. To use <i>parameter 25-04 Pump Cycling</i> , the cascade controller is monitoring the relay ON time.	

25-86 Reset Relay Counters		
Option:	Function:	
	Resets all elements in <i>parameter 25-85 Relay ON Time</i> counters.	
[0] *	Do not reset	
[1]	Do reset	

3.22.6 25-9* Service

Parameters used if there is a service on 1 or more of the pumps controlled.

3

25-90 Pump Interlock		
Array [10]		
Option: Function:		
		In this parameter, it is possible to disable 1 or more of the fixed lead pumps. For example, the pump is not selected for staging on even if it is the next pump in the operation sequence. It is not possible to disable the lead pump with the pump interlock command. The digital input interlocks are selected as [130] Pump 1 Interlock – [132] Pump 1 Interlock in parameter group 5-1* Digital In/Out.
[0] *	Off	The pump is active for staging/destaging.
[1]	On	The pump interlock command is given. If a pump runs, it is immediately destaged. If the pump does not run, it is not allowed to stage on.

25-91 Manual Alternation		
Range:		Function:
0*	[0 - par. 25-06]	Readout parameter for the actual variable speed pump in the system. When an alternation takes place, the lead pump parameter is updated to reflect the current variable speed pump in the system. If no lead pump is selected (cascade controller disabled or all pumps interlocked), the display shows N1.

3.23 Parameters 26-** Analog I/O Option MCB 109

The VLT® Analog I/O Option MCB 109 extends the functionality of VLT® AQUA Drive FC 202 Series frequency converters by adding some extra, programmable analog inputs and outputs. This is useful in control installations where the frequency converter may be used as decentral I/O, obviating the need for an outstation and thus reducing cost. It also provides flexibility in project planning.

NOTICE!

The maximum current for the analog outputs 0–10 V is 1 mA.

NOTICE!

Where live zero monitoring is used, it is important that any analog inputs not being used for the frequency controller, for example being used as part of the building management system decentral I/O, have their live zero function disabled.

Terminal	Parameters
Analog inputs	
X42/1	Parameter 26-00 Terminal X42/1 Mode, parameter 26-10 Terminal X42/1 Low Voltage.
X42/3	Parameter 26-01 Terminal X42/3 Mode, parameter 26-20 Terminal X42/3 Low Voltage.
X42/5	Parameter 26-02 Terminal X42/5 Mode, parameter 26-30 Terminal X42/5 Low Voltage.
Analog outputs	
X42/7	Parameter 26-40 Terminal X42/7 Output.
X42/9	Parameter 26-50 Terminal X42/9 Output.
X42/11	Parameter 26-60 Terminal X42/11 Output.
Analog inputs	
53	Parameter group 6-1* Analog Input 1.
54	Parameter group 6-2* Analog Input 2.
Analog output	
42	Parameter group 6-5* Analog Input 1.
Relays	
Relay 1, terminals 1, 2, 3.	Parameter group 5-4* Relays.
Relay 2, terminals 4, 5, 6.	Parameter group 5-4* Relays.

Table 3.34 Analog Inputs

It is also possible to read the analog inputs, write to the analog outputs, and control the relays, using communication via the fieldbus.

Terminal	Parameters
Analog inputs (read)	
X42/1	Parameter 18-30 Analog Input X42/1.
X42/3	Parameter 18-31 Analog Input X42/3.
X42/5	Parameter 18-32 Analog Input X42/5.
Analog outputs (write)	
X42/7	Parameter 18-33 Analog Out X42/7 [V].
X42/9	Parameter 18-34 Analog Out X42/9 [V].
X42/11	Parameter 18-35 Analog Out X42/11 [V].
Analog inputs (read)	
53	Parameter 16-62 Analog Input 53.
54	Parameter 16-64 Analog Input 54.
Analog output	
42	Parameter 6-63 Terminal X30/8 Output Bus Control.
Relays	
Relay 1, terminals 1, 2, 3.	Parameter 16-71 Relay Output [bin].
Relay 2, terminals 4, 5, 6.	Parameter 16-71 Relay Output [bin].

NOTICE!
Enable the relay outputs via control word bit 11 (relay 1) and bit 12 (relay 2).

Table 3.35 Analog Inputs via Fieldbus

On-board real-time clock setting

The VLT® Analog I/O Option MCB 109 incorporates a real-time clock with battery back-up. This option can be used as back-up of the standard clock function included in the frequency converter. See *parameter group 0-7* Clock Settings*.

Use the MCB 109 for control of devices such as actuators or valves, using the extended closed-loop facility, thus removing control from the existing control system. See *parameter group 21-** Extended Closed Loop*. There are 3 independent closed-loop PID controllers.

26-00 Terminal X42/1 Mode		
Option:	Function:	
		Terminal X42/1 can be programmed as an analog input accepting a voltage or input from either Pt1000 (1000 Ω at 0 °C (32 °F)) or Ni 1000 (1000 Ω at 0 °C (32 °F)) temperature sensors. Select the mode. [2] Pt 1000 [°C] and [4] Ni 1000 [°C] if operating in Celsius, or [3] Pt 1000 [°F] and [5] Ni 1000 [°F] if operating in Fahrenheit.
		NOTICE! If the input is not in use, set it for voltage.
		If set for temperature and used as feedback, set the unit for either Celsius or Fahrenheit. <ul style="list-style-type: none"> Parameter 20-12 Reference/Feedback Unit. Parameter 21-10 Ext. 1 Ref./Feedback Unit. Parameter 21-30 Ext. 2 Ref./Feedback Unit. Parameter 20-05 Feedback 2 Source Unit.
[1] *	Voltage	
[2]	Pt 1000 [°C]	
[3]	Pt 1000 [°F]	
[4]	Ni 1000 [°C]	
[5]	Ni 1000 [°F]	

26-01 Terminal X42/3 Mode	
Option:	Function:
	<p>Terminal X42/3 can be programmed as an analog input accepting a voltage or input from either Pt 1000 or Ni 1000 temperature sensors. Select the mode.</p> <p>[2] Pt 1000 [°C] and [4] Ni 1000 [°C] if operating in Celsius, or [3] Pt 1000 [°F] and [5] Ni 1000 [°F] if operating in Fahrenheit.</p> <p>NOTICE! If the input is not in use, set it for voltage.</p> <p>If set for temperature and used as feedback, set the unit for either Celsius or Fahrenheit.</p> <ul style="list-style-type: none"> Parameter 20-12 Reference/Feedback Unit. Parameter 21-10 Ext. 1 Ref./Feedback Unit. Parameter 21-30 Ext. 2 Ref./Feedback Unit. Parameter 20-05 Feedback 2 Source Unit.
[1] *	Voltage
[2]	Pt 1000 [°C]
[3]	Pt 1000 [°F]
[4]	Ni 1000 [°C]
[5]	Ni 1000 [°F]

26-02 Terminal X42/5 Mode	
Option:	Function:
	<p>Terminal X42/5 can be programmed as an analog input accepting a voltage or input from either Pt 1000 (1000 Ω at 0 °C) or Ni 1000 (1000 Ω at 0 °C) temperature sensors. Select the mode.</p> <p>[2] Pt 1000 [°C] and [4] Ni 1000 [°C] if operating in Celsius, or [3] Pt 1000 [°F] and [5] Ni 1000 [°F] if operating in Fahrenheit.</p> <p>NOTICE! If the input is not in use, set it for voltage.</p> <p>If set for temperature and used as feedback, set the unit for either Celsius or Fahrenheit:</p> <ul style="list-style-type: none"> Parameter 20-12 Reference/Feedback Unit. Parameter 21-10 Ext. 1 Ref./Feedback Unit.

26-02 Terminal X42/5 Mode	
Option:	Function:
	<ul style="list-style-type: none"> Parameter 21-30 Ext. 2 Ref./Feedback Unit. Parameter 20-05 Feedback 2 Source Unit.
[1] *	Voltage
[2]	Pt 1000 [°C]
[3]	Pt 1000 [°F]
[4]	Ni 1000 [°C]
[5]	Ni 1000 [°F]

26-10 Terminal X42/1 Low Voltage		
Range:	Function:	
0.07 V* [0 - par. 6-31 V]	Enter the low voltage value. This analog input scaling value should correspond to the low reference/feedback value set in parameter 26-14 Term. X42/1 Low Ref./Feedb. Value.	

26-11 Terminal X42/1 High Voltage		
Range:	Function:	
10 V* [par. 6-30 - 10 V]	Enter the high-voltage value. This analog input scaling value should correspond to the high reference/feedback value set in parameter 26-15 Term. X42/1 High Ref./Feedb. Value.	

26-14 Term. X42/1 Low Ref./Feedb. Value		
Range:	Function:	
0 ReferenceFeed-backUnit* [-999999.999 - 999999.999 ReferenceFeed-backUnit]	Enter the analog input scaling value that corresponds to the low-voltage value set in parameter 26-10 Terminal X42/1 Low Voltage.	

26-15 Term. X42/1 High Ref./Feedb. Value		
Range:	Function:	
100 Reference-FeedbackUnit* [-999999.999 - 999999.999 ReferenceFeed-backUnit]	Enter the analog input scaling value that corresponds to the high-voltage value set in parameter 26-11 Terminal X42/1 High Voltage.	

26-16 Term. X42/1 Filter Time Constant		
Range:		Function:
0.005 s*	[0.005 - 10 s]	<p>NOTICE!</p> <p>This parameter cannot be adjusted while the motor is running.</p> <p>This is a first-order digital low-pass filter time constant for suppressing noise in terminal X42/1. A high time constant value improves dampening, but also increases the time delay through the filter.</p>

26-17 Term. X42/1 Live Zero		
Option:		Function:
		This parameter makes it possible to enable the live zero monitoring, for example, where the analog input is the frequency converter control, rather than being used as a decentral I/O system, such as a building management system.
[0]	Disabled	
[1] *	Enabled	

26-20 Terminal X42/3 Low Voltage		
Range:		Function:
0.07 V*	[0 - par. 6-31 V]	Enter the low voltage value. This analog input scaling value should correspond to the low reference/feedback value set in <i>parameter 26-24 Term. X42/3 Low Ref./Feedb. Value.</i>

26-21 Terminal X42/3 High Voltage		
Range:		Function:
10 V*	[par. 6-30 - 10 V]	Enter the high-voltage value. This analog input scaling value should correspond to the high reference/feedback value set in <i>parameter 26-25 Term. X42/3 High Ref./Feedb. Value.</i>

26-24 Term. X42/3 Low Ref./Feedb. Value		
Range:		Function:
0 ReferenceFeed-backUnit*	[-999999.999 - 999999.999 ReferenceFeed-backUnit]	Enter the analog input scaling value that corresponds to the low-voltage value set in <i>parameter 26-20 Terminal X42/3 Low Voltage.</i>

26-25 Term. X42/3 High Ref./Feedb. Value		
Range:		Function:
100 Reference-FeedbackUnit*	[-999999.999 - 999999.999 ReferenceFeed-backUnit]	Enter the analog input scaling value that corresponds to the high-voltage value set in <i>parameter 26-21 Terminal X42/3 High Voltage.</i>

26-26 Term. X42/3 Filter Time Constant		
Range:		Function:
0.005 s*	[0.005 - 10 s]	<p>NOTICE!</p> <p>This parameter cannot be adjusted while the motor is running.</p> <p>Enter the time constant. This is a first-order digital low-pass filter time constant for suppressing noise in terminal X42/3. A high time constant value improves dampening, but also increases the time delay through the filter.</p>

26-27 Term. X42/3 Live Zero		
Option:		Function:
		This parameter makes it possible to enable the live zero monitoring, for example, where the analog input is the frequency converter control, rather than being used as a decentral I/O system, such as a building management system.
[0]	Disabled	
[1] *	Enabled	

26-30 Terminal X42/5 Low Voltage		
Range:		Function:
0.07 V*	[0 - par. 6-31 V]	Enter the low-voltage value. This analog input scaling value should correspond to the low reference/feedback value set in <i>parameter 26-34 Term. X42/5 Low Ref./Feedb. Value.</i>

26-31 Terminal X42/5 High Voltage		
Range:		Function:
10 V*	[par. 6-30 - 10 V]	Enter the high-voltage value. This analog input scaling value should correspond to the high reference/feedback value set in <i>parameter 26-35 Term. X42/5 High Ref./Feedb. Value.</i>

26-34 Term. X42/5 Low Ref./Feedb. Value		
Range:		Function:
0 ReferenceFeed-backUnit*	[-999999.999 - 999999.999 ReferenceFeed-backUnit]	Enter the analog input scaling value that corresponds to the low-voltage value set in <i>parameter 26-30 Terminal X42/5 Low Voltage</i> .

26-35 Term. X42/5 High Ref./Feedb. Value		
Range:		Function:
100 Reference-FeedbackUnit*	[-999999.999 - 999999.999 ReferenceFeed-backUnit]	Enter the analog input scaling value that corresponds to the high-voltage value set in <i>parameter 26-21 Terminal X42/3 High Voltage</i> .

26-36 Term. X42/5 Filter Time Constant		
Range:		Function:
0.005 s*	[0.005 - 10 s]	<p>NOTICE! This parameter cannot be adjusted while the motor is running.</p> <p>This is a first-order digital low-pass filter time constant for suppressing noise in terminal X42/5. A high time constant value improves dampening, but also increases the time delay through the filter.</p>

26-37 Term. X42/5 Live Zero		
Option:		Function:
		Enable or disable the live zero monitoring.
[0]	Disabled	
[1] *	Enabled	

26-40 Terminal X42/7 Output		
Option:		Function:
		Set the function of terminal X42/7 as an analog current output.
[0] *	No operation	
[52]	MCO 0-20mA/0-10V	
[100]	Output freq. 0-100	0-100 Hz, (0-10 V).
[101]	Reference Min-Max	Minimum reference-maximum reference, (0-10 V).
[102]	Feedback +200%	-200% to +200% of <i>parameter 3-03 Maximum Reference</i> , (0-10 V).

26-40 Terminal X42/7 Output		
Option:		Function:
[103]	Motor cur. 0-lmax	0-inverter maximum current (<i>parameter 16-37 Inv. Max. Current</i>), (0-10 V).
[104]	Torque 0-Tlim	0-torque limit (<i>parameter 4-16 Torque Limit Motor Mode</i>), (0-10 V).
[105]	Torque 0-Tnom	0-motor rated torque, (0-10 V).
[106]	Power 0-Pnom	0-motor rated power, (0-10 V).
[107]	Speed 0-HighLim	0-speed high limit (<i>parameter 4-13 Motor Speed High Limit [RPM]</i> and <i>parameter 4-14 Motor Speed High Limit [Hz]</i>), (0-10 V).
[108]	Torque +160%	
[109]	Out frq 0-Fmax	
[113]	Ext. Closed Loop 1	0-100%, (0-10 V).
[114]	Ext. Closed Loop 2	0-100%, (0-10 V).
[115]	Ext. Closed Loop 3	0-100%, (0-10 V).
[139]	Bus ctrl.	0-100%, (0-10 V).
[141]	Bus ctrl t.o.	0-100%, (0-10 V).
[156]	Flow Rate	

26-41 Terminal X42/7 Min. Scale		
Range:		Function:
0 %*	[0 - 200 %]	Scale the minimum output of the selected analog signal at terminal X42/7 as a percentage of the maximum signal level. For example, if 0 V (or 0 Hz) is required at 25% of the maximum output value, program 25%. Scaling values up to 100% can never be higher than the corresponding setting in <i>parameter 26-42 Terminal X42/7 Max. Scale</i> . See principle graph for <i>parameter 6-51 Terminal 42 Output Min Scale</i> .

26-42 Terminal X42/7 Max. Scale		
Range:	Function:	
100 %*	[0 - 200 %]	Scale the maximum output of the selected analog signal at terminal X42/7. Set the value to the maximum value of the voltage signal output. Scale the output to give a voltage lower than 10 V at full scale; or 10 V at an output below 100% of the maximum signal value. If 10 V is the required output current at a value between 0–100% of the full-scale output, program the percentage value in the parameter, that is 50%=10 V. If a voltage 0–10 V is required at maximum output, calculate the percentage as follows: $\left(\frac{10V}{\text{desired maximum voltage}} \right) \times 100\%$ that is $5V: \frac{10V}{5V} \times 100\% = 200\%$ See Figure 3.36.

26-43 Terminal X42/7 Bus Control		
Range:	Function:	
0 %*	[0 - 100 %]	Holds the level of terminal X42/7 if controlled by bus.

26-44 Terminal X42/7 Timeout Preset		
Range:	Function:	
0 %*	[0 - 100 %]	Holds the preset level of terminal X42/7. If a fieldbus and a timeout function are selected in <i>parameter 26-50 Terminal X42/9 Output</i> , the output presets to this level.

26-50 Terminal X42/9 Output		
Option:	Function:	
		Set the function of terminal X42/9.
[0] *	No operation	
[52]	MCO 0-20mA/ 0-10V	
[100]	Output freq. 0-100	0–100 Hz, (0–10 V).
[101]	Reference Min-Max	Minimum reference–maximum reference, (0–10 V).
[102]	Feedback +-200%	-200% to +200% of <i>parameter 3-03 Maximum Reference</i> , (0–10 V).
[103]	Motor cur. 0-lmax	0–inverter maximum current (<i>parameter 16-37 Inv. Max. Current</i>), (0–10 V).
[104]	Torque 0-Tlim	0–torque limit (<i>parameter 4-16 Torque Limit Motor Mode</i>), (0–10 V).

26-50 Terminal X42/9 Output		
Option:	Function:	
[105]	Torque 0-Tnom	0–motor rated torque, (0–10 V).
[106]	Power 0-Pnom	0–motor rated power, (0–10 V).
[107]	Speed 0-HighLim	0–speed high limit (<i>parameter 4-13 Motor Speed High Limit [RPM]</i> and <i>parameter 4-14 Motor Speed High Limit [Hz]</i>), (0–10 V).
[108]	Torque +-160%	
[109]	Out freq 0-Fmax	
[113]	Ext. Closed Loop 1	0–100%, (0–10 V).
[114]	Ext. Closed Loop 2	0–100%, (0–10 V).
[115]	Ext. Closed Loop 3	0–100%, (0–10 V).
[139]	Bus ctrl.	0–100%, (0–10 V).
[141]	Bus ctrl t.o.	0–100%, (0–10 V).
[156]	Flow Rate	

26-51 Terminal X42/9 Min. Scale		
For more information, see <i>parameter 6-51 Terminal 42 Output Min Scale</i> .		
Range:	Function:	
0 %*	[0 - 200 %]	Scale the minimum output of the selected analog signal at terminal X42/9 as a percentage of the maximum signal level. For example, if 0 V is required at 25% of the maximum output value, program 25%. Scaling values up to 100% can never be higher than the corresponding setting in <i>parameter 26-52 Terminal X42/9 Max. Scale</i> .

26-52 Terminal X42/9 Max. Scale		
See Figure 3.36.		
Range:	Function:	
100 %*	[0 - 200 %]	Scale the maximum output of the selected analog signal at terminal X42/9. Set the value to the maximum value of the voltage signal output. Scale the output to give a voltage lower than 10 V at full scale; or 10 V at an output below 100% of the maximum signal value. If 10 V is the required output current at a value between 0–100% of the full-scale output, program the percentage value in the parameter, that is, 50%=10 V. If a voltage 0–10 V is required at maximum output, calculate the percentage as follows: $5V: \frac{10V}{5V} \times 100\% = 200\%$

26-53 Terminal X42/9 Bus Control		
Range:		Function:
0 %*	[0 - 100 %]	Holds the level of terminal X42/9 if controlled by bus.

26-54 Terminal X42/9 Timeout Preset		
Range:		Function:
0 %*	[0 - 100 %]	Holds the preset level of terminal X42/9. If a fieldbus and a timeout function are selected in <i>parameter 26-60 Terminal X42/11 Output</i> , the output presets to this level.

26-60 Terminal X42/11 Output		
Option:		Function:
		Set the function of terminal X42/11.
[0] *	No operation	
[52]	MCO 0-20mA/ 0-10V	
[100]	Output freq. 0-100	0-100 Hz, (0-10 V).
[101]	Reference Min- Max	Minimum reference-maximum reference, (0-10 V).
[102]	Feedback +-200%	-200% to +200% of <i>parameter 3-03 Maximum Reference</i> , (0-10 V).
[103]	Motor cur. 0-lmax	0-inverter maximum current (<i>parameter 16-37 Inv. Max. Current</i>), (0-10 V).
[104]	Torque 0-Tlim	0-torque limit (<i>parameter 4-16 Torque Limit Motor Mode</i>), (0-10 V).
[105]	Torque 0-Tnom	0-motor rated torque, (0-0 V).
[106]	Power 0-Pnom	0-motor rated power, (0-10 V).
[107]	Speed 0-HighLim	0-speed high limit (<i>parameter 4-13 Motor Speed High Limit [RPM]</i> and <i>parameter 4-14 Motor Speed High Limit [Hz]</i>), (0-10 V).
[108]	Torque +-160%	
[109]	Out frq 0-Fmax	
[113]	Ext. Closed Loop 1	0-100%, (0-10 V).
[114]	Ext. Closed Loop 2	0-100%, (0-10 V).
[115]	Ext. Closed Loop 3	0-100%, (0-10 V).
[139]	Bus ctrl.	0-100%, (0-10 V).
[141]	Bus ctrl t.o.	0-100%, (0-10 V).
[156]	Flow Rate	

26-61 Terminal X42/11 Min. Scale		
For more information, see <i>parameter 6-51 Terminal 42 Output Min Scale</i> .		
Range:		Function:
0 %*	[0 - 200 %]	Scale the minimum output of the selected analog signal at terminal X42/11 as a percentage of the maximum signal level. For example, if 0 V is required at 25% of the maximum output value, program 25%. Scaling values up to 100% can never be higher than the corresponding setting in <i>parameter 26-62 Terminal X42/11 Max. Scale</i> .

26-62 Terminal X42/11 Max. Scale		
See <i>Figure 3.36</i> .		
Range:		Function:
100 %*	[0 - 200 %]	Scale the maximum output of the selected analog signal at terminal X42/9. Set the value to the maximum value of the voltage signal output. Scale the output to give a voltage lower than 10 V at full scale; or 10 V at an output below 100% of the maximum signal value. For example, if 10 V is the required output current at a value between 0-100% of the full-scale output, program the percentage value in the parameter, that is, 50%=10 V. If a voltage 0-10 V is required at maximum output, calculate the percentage as follows: $\left(\frac{10V}{\text{desired maximum voltage}} \right) \times 100\%$ that is $5V: \frac{10V}{5V} \times 100\% = 200\%$

26-63 Terminal X42/11 Bus Control		
Range:		Function:
0 %*	[0 - 100 %]	Holds the level of terminal X42/11 if controlled by bus.

26-64 Terminal X42/11 Timeout Preset		
Range:		Function:
0 %*	[0 - 100 %]	Holds the preset level of terminal X42/11. If a fieldbus and a timeout function are selected, the output presets to this level.

3

3.24 Parameters 27-** Cascade CTL Option

Parameter group 27-** Cascade CTL Option is available if 1 of the following conditions is met:

- VLT® Extended Cascade Controller MCO 101 is installed.
- VLT® Advanced Cascade Controller MCO 102 is installed.
- The frequency converter was ordered with the type code LXX1.

Relay wiring configuration using MCO 101 or MCO 102

For a detailed description of commissioning for mixed pump and master/slave applications (using relay operation), refer to *VLT® Cascade Controller Options MCO 101/102 Operating Instructions*.

Serial communication wiring configuration

The serial communication wiring configuration supports the master/slave cascade controller set-up controlling up to 8 pumps in total.

At least 1 of the frequency converters in the set-up must have *parameter group 27-** Cascade CTL Option* enabled. That enables option *Modbus CASCADE Master* in *parameter 8-30 Protocol*.

The frequency converter with the lowest address and the cascade controller capability is set as the primary master. The remaining frequency converters must be addressed with a unique address or forward-running number. For slave frequency converters, option *Modbus RTU* in *parameter 8-30 Protocol* has to be set. Reaction at communication loss can be set in *parameter 8-03 Control Timeout Time* and *parameter 8-04 Control Timeout Function*. Apply this setting to all frequency converters in the system.

This configuration only supports the master/slave mode.

NOTICE!

Terminate the RS485 bus with a resistor at both ends. For this purpose, set switch S801 on the control card to ON.

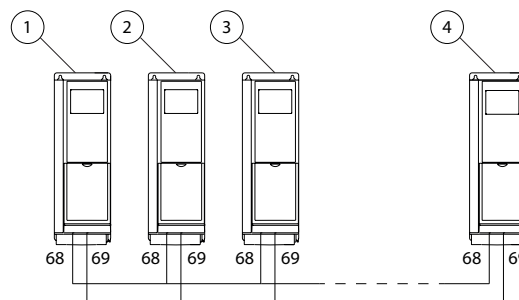

e30bg296.10

1	Primary master 1
2	Slave 1
3	Slave 2
4	Slave X (up to 7 slaves)

Figure 3.95 Serial Communication Wiring

3.24.1 Master/Slave Configuration

The master/slave cascade control mode offers the best performance, the most precise control, and maximum energy savings. This mode controls multiple equally sized pumps in parallel, running all pumps at the same speed and stages the pumps on and off according to system requirements.

Compared to the closed-loop cascade control, staging and destaging decisions are made based on the speed calculated by frequency converters instead of feedback. Set the stage-on and stage-off speed according to the system requirements to obtain the highest energy saving. In the master/slave configuration, the master frequency converter is running in closed loop, and the slave frequency converters are running in open loop. All slave frequency converters are connected to mains and the motors in the same way as the master frequency converter. In this configuration, each pump is controlled by a frequency converter. All pumps and frequency converters must be of the same size.

3.24.2 Mixed Pump Configuration

This configuration combines some of the benefits of the master/slave configuration with some of the initial cost savings of the fixed speed configuration. Use this configuration when the extra capacity of the fixed pumps is rarely needed.

The mixed pump configuration supports a mix of variable speed pumps connected to the frequency converters with extra fixed speed pumps. The variable speed pumps are staged on and destaged first based on the frequency

converter speed. The fixed speed pumps are then staged on last and destaged last based on the feedback pressure.

NOTICE!

All frequency converters must have the same power range. All variable speed pumps must be of the same size. Fixed speed pumps may be of different sizes. See Figure 3.96.

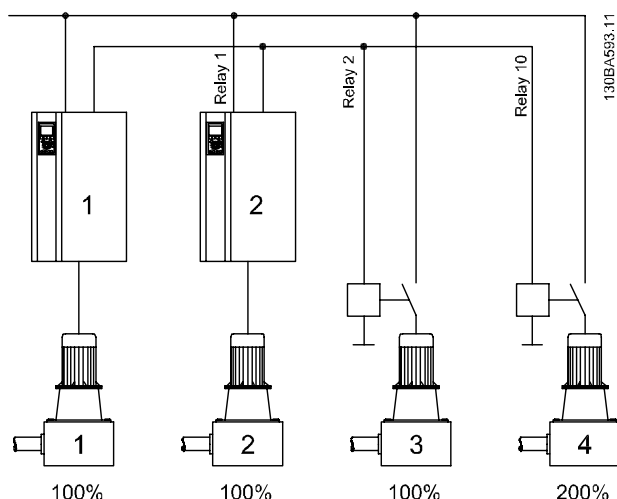

Figure 3.96 Mixed Pump Configuration

3.24.3 Unequal Pump Size Configuration

The unequal pump size configuration supports a limited mix of fixed speed pumps in different sizes. This configuration provides the largest range of system output with the smallest number of pumps.

3.24.4 Using Soft Starters for Fixed Speed Pumps

In a mixed pump configuration, contractors can be replaced with soft starters.

NOTICE!

Mixing soft starters and contactors hinders the control of output pressure during the staging and destaging transitions. The use of soft starters delays staging due to the ramp time of a fixed speed pump.

27-01 Pump Status		
Shows the status of each pump in the system.		
Option:	Function:	
[0] *	Ready	The pump is available for use by the Cascade Controller.
[1]	On Drive	The pump is: <ul style="list-style-type: none"> Running. Connected to the frequency converter. Controlled by the Cascade Controller.
[2]	On Mains	The pump is: <ul style="list-style-type: none"> Running. Connected to mains. Controlled by the Cascade Controller.
[3]	Offline - Off	The pump is off and not available for use by the Cascade Controller.
[4]	Offline - On Mains	The pump is: <ul style="list-style-type: none"> Running. Connected to mains. Not available for use by the Cascade Controller.
[5]	Offline - On Drive	The pump is: <ul style="list-style-type: none"> Running. Connected to the frequency converter. Not available for use by the Cascade Controller.
[6]	Offline - Fault	The pump is: <ul style="list-style-type: none"> Running. Connected to mains. Not available for use by the Cascade Controller.
[7]	Offline - Hand	The pump is: <ul style="list-style-type: none"> Running. Connected to mains. Not available for use by the Cascade Controller.
[8]	Offline - External Interlock	The pump is off and is externally interlocked.
[9]	Spinning	The Cascade Controller is executing a spin cycle of the pump.

27-01 Pump Status		
Shows the status of each pump in the system.		
Option:		Function:
[10]	No Relay Connection	The pump is not directly connected to the frequency converter, and a relay is not assigned to the pump.

27-02 Manual Pump Control		
This parameter is a command parameter that allows manual control of individual pump states. Selecting one of the options executes the command in the option and then returns to option [0] No Operation.		
Option:		Function:
[0] *	No Operation	The frequency converter does not issue any commands.
[1]	Online	Makes the pump available to the Cascade Controller.
[2]	Alternate On	Forces the selected pump to be the lead pump.
[3]	Offline - Off	Turns off the pump and makes the pump unavailable for cascading.
[4]	Offline - On	Turns on the pump and makes the pump unavailable for cascading.
[5]	Offline - Spin	Initiates a pump spin.

27-03 Current Runtime Hours		
Range:		Function:
0 h*	[0 - 2147483647 h]	Shows the total number of hours each pump has run since the last reset. This value is used to balance the running hours between pumps. To reset the value to 0, use <i>parameter 27-91 Cascade Reference</i> .

27-04 Pump Total Lifetime Hours		
Range:		Function:
0 h*	[0 - 2147483647 h]	Shows the total hours run for each connected pump.

NOTICE!

This parameter may be set to a certain value for maintenance purposes.

3.24.5 27-1* Configuration

Parameters for configuring the Cascade Controller option.

27-10 Cascade Controller		
Select the operating mode of the Cascade Controller. To enable the Cascade Controller functionality, set <i>parameter 1-00 Configuration Mode</i> to option [3] Closed Loop.		
Option:		Function:
[0]	Disabled	Turns off the Cascade Controller option.
[1]	Master/Follower	Select this option to use only variable speed pumps connected to frequency converters. Selecting this option sets <i>parameter 8-30 Protocol</i> to [22] Cascade Modbus Master.
[2]	Mixed Pumps	Select this option to use both variable and fixed speed pumps.
[3]	Basic Cascade Ctrl	Turns off the cascade option and reverts to basic cascade operation (see <i>parameter group 25-** Cascade Controller</i> for more information). Selecting this option increases the number of pumps that the basic Cascade Controller can control. The additional relays on the option can be used to extend the basic Cascade Controller with 3 relays.

27-11 Number Of Drives		
Range:		Function:
Size related*	[1 - 8]	Shows the number of frequency converters that the Cascade Controller controls. Depending on the option installed, the Cascade Controller can control the following number of frequency converters: <ul style="list-style-type: none"> • VLT® Extended Cascade Controller MCO 101: 1–6. • VLT® Advanced Cascade Controller MCO 102: 1–8. • Cascade CTL License software (type code LXX1): 1–8.

27-12 Number Of Pumps		
Range:		Function:
Size related*	[2 - 8]	Shows the number of pumps that the Cascade Controller controls. Depending on the configuration, the Cascade Controller can control the following number of pumps: <ul style="list-style-type: none"> • VLT® Extended Cascade Controller MCO 101: 0–6. • VLT® Advanced Cascade Controller MCO 102: 0–8. • Cascade CTL License software (type code LXX1): 1–8.

27-14 Pump Capacity		
Range:		Function:
Size related*	[10 - 800 %]	Enter the capacity of each pump in the system relative to the first pump. This is an indexed parameter with one entry per pump. The capacity of the first pump is 100%.

27-16 Runtime Balancing		
Set the priority of each pump for balancing its running hours. Pumps with the same priority are staged/destaged based on the running hours.		
Option:		Function:
[0] *	Balanced Priority 1	Turned on first, turned off last.
[1]	Balanced Priority 2	Turned on if no priority 1 pumps are available. Turned off before priority 1 pumps are turned off.
[2]	Spare Pump	Turned on last, turned off first.

27-17 Motor Starters		
Option:		Function:
		Select the type of the mains starter for the fixed speed pumps. All fixed speed pumps must have the same starter type.
[0] *	Direct Online	
[1]	Soft Starter	This option adds a delay when staging and destaging pumps. The delay is defined in <i>parameter 27-41 Ramp Down Delay</i> and <i>parameter 27-42 Ramp Up Delay</i> .
[2]	Star/Delta	This option adds a delay when staging pumps. The delay is defined in <i>parameter 27-42 Ramp Up Delay</i> .

27-18 Spin Time for Unused Pumps		
Range:		Function:
Size related*	[0 - 99 s]	Enter the time to spin unused pumps. If a fixed speed pump has not run in the last 72 hours, it is turned on for this time. This function prevents the damage caused by leaving the pump off for too long. To disable the function, set the value of this parameter to 0.

CAUTION

Ensure that the value in this parameter does not cause overpressure in the system.

27-19 Reset Current Runtime Hours		
Select <i>option [1] Do reset</i> to reset all current run-time hours to 0. The run-time hours value is used for run-time balancing.		
Option:		Function:
[0] *	Do not reset	
[1]	Do reset	

3.24.6 27-2* Bandwidth Settings

Parameters for configuring the control response.

27-20 Normal Operating Range		
Range:		Function:
Size related*	[1 - 100 %]	Enter the maximum offset from the setpoint before a pump may be added or removed. The value is a percentage of <i>parameter 21-12 Ext. 1 Maximum Reference</i> . The system must be outside the normal operating range for the time specified in <i>parameter 27-23 Staging Delay</i> or <i>parameter 27-24 Destaging Delay</i> before a cascade operation takes place. Normal operation is operation with at least one variable speed pump available.

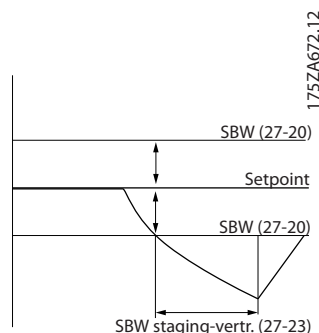

Figure 3.97 SBW Staging Delay

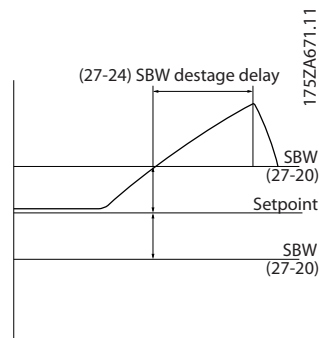

Figure 3.98 SBW Destaging Delay

27-21 Override Limit		
Range:	Function:	
100 %*	[0 - 100 %]	Enter the maximum offset from the setpoint before a pump is added or removed immediately (for instance, if there was a sudden water demand). The value is the percentage of <i>parameter 21-12 Ext. 1 Maximum Reference</i> . This parameter allows responding to sudden changes in demand without a delay. The override functionality can be disabled by setting this parameter to 100%.

NOTICE!

In master/slave applications, the override limit is used as the wake-up condition. See documentation for *Cascade Controller Option MCO 101* for further information.

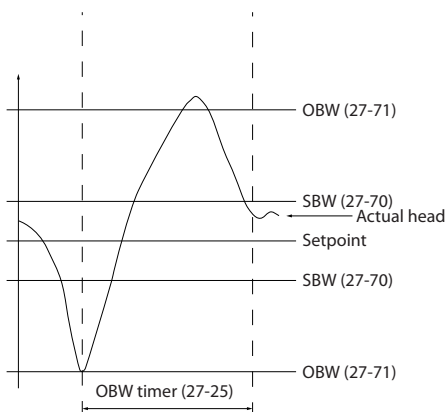

Figure 3.99 OBW Time

27-22 Fixed Speed Only Operating Range		
Range:	Function:	
Size related*	[0 - par. 27-21 %]	Enter the allowed offset from the setpoint at which a fixed speed pump is added or removed when there are no operational variable speed pumps. The value is a percentage of <i>parameter 21-12 Ext. 1 Maximum Reference</i> . The system must be outside this limit for the time specified in <i>parameter 27-23 Staging Delay</i> or <i>parameter 27-24 Destaging Delay</i> before a cascade operation takes place.

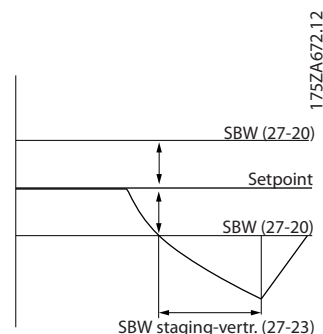

Figure 3.100 SBW Staging Delay

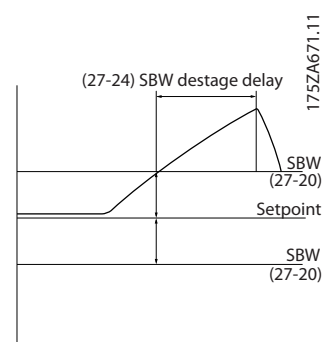

Figure 3.101 SBW Destaging Delay

27-23 Staging Delay		
Range:	Function:	
15 s*	[0 - 3000 s]	Enter the time during which the system feedback must remain below the operating range before a fixed speed pump is turned on. If the system is operating with at least 1 variable speed pump available, <i>parameter 27-20 Normal Operating Range</i> is used. If no variable speed pumps are available, <i>parameter 27-22 Fixed Speed Only Operating Range</i> is used.

27-24 Destaging Delay		
Range:	Function:	
15 s*	[0 - 3000 s]	Enter the time during which the system feedback must remain above the operating range before a pump is turned off. If the system is operating with at least 1 variable speed pump available, <i>parameter 27-20 Normal Operating Range</i> is used. If no variable speed pumps are available, <i>parameter 27-22 Fixed Speed Only Operating Range</i> is used.

27-25 Override Hold Time		
Range:	Function:	
10 s*	[0 - 300 s]	Enter the minimum time that must elapse after staging or destaging before another staging or destaging may take place due to the system exceeding the value in <i>parameter 27-21 Override Limit</i> . This value allows the system to stabilize after a pump is turned on or off. If this delay is not long enough, the transients caused by turning a pump on or off may cause the system to add or remove another pump unnecessarily.

27-27 Min Speed Destage Delay		
Range:	Function:	
Size related*	[0 - 300 s]	Enter the time that the lead pump must run at minimum speed while the system feedback is still inside the normal operating band before a pump is turned off to save energy. Energy savings are achieved by turning off a pump if all variable speed pumps are operating at minimum speed, but the feedback is still within the specified band. Under these conditions, a pump may be turned off and the system is still able to maintain control. The pumps that remain on operate more efficiently.

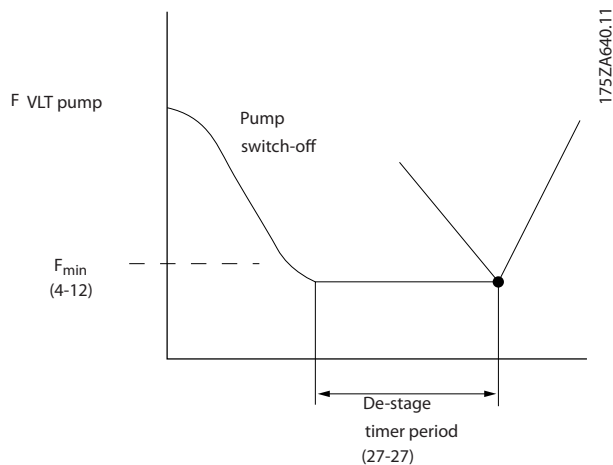

Figure 3.102 Destage Function Time

3.24.7 27-3* Staging Speed

Parameters for configuring the master/slave control response.

27-30 Auto Tune Staging Speeds		
Option:	Function:	
[0]	Disabled	

27-30 Auto Tune Staging Speeds		
Option:	Function:	
[1] *	Enabled	When this option is selected, the frequency converter calculates and keeps <i>parameters 27-31 to 27-34</i> up to date. If <i>parameter 27-31 Stage On Speed [RPM]</i> , <i>parameter 27-32 Stage On Speed [Hz]</i> , <i>parameter 27-33 Stage Off Speed [RPM]</i> , and <i>parameter 27-34 Stage Off Speed [Hz]</i> are modified via the fieldbus or LCP, then the new values are used but are continuously automatically tuned. The frequency converter recalculates and updates the parameters when staging occurs and optimizes the settings to ensure high performance and low energy consumption.

27-31 Stage On Speed [RPM]		
Range:	Function:	
Size related*	[0 - par. 4-13 RPM]	To be used if RPM is selected. If the lead pump is operating above Stage On Speed for the time specified in <i>parameter 27-23 Staging Delay</i> and a variable speed pump is available, it is turned on.

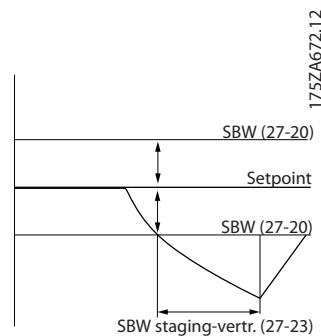

Figure 3.103 SBW Staging Delay

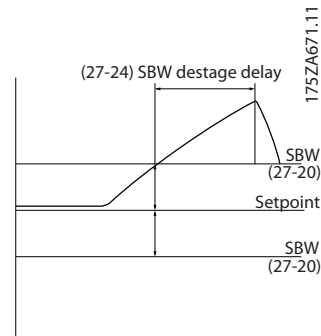

Figure 3.104 SBW Destaging Delay

27-32 Stage On Speed [Hz]		
Range:		Function:
Size related*	[0 - par. 4-14 Hz]	If the lead pump speed is exceeding the value in this parameter for the time specified in <i>parameter 27-23 Staging Delay</i> and a variable speed pump is available, the variable pump is turned on.

27-33 Stage Off Speed [RPM]		
Range:		Function:
Size related*	[0 - 1500 RPM]	If the lead pump speed is lower than the value in this parameter for the time specified in <i>parameter 27-24 Destaging Delay</i> and more than 1 variable speed pump is on, a variable speed pump is turned off.

27-34 Stage Off Speed [Hz]		
Range:		Function:
Size related*	[0.0 - 50 Hz]	If the lead pump speed is lower than the value in this parameter for the time specified in <i>parameter 27-24 Destaging Delay</i> and more than 1 variable speed pump is on, a variable speed pump is turned off.

3.24.8 27-4* Staging Settings

Parameters for configuring the staging transitions.

27-40 Auto Tune Staging Settings		
When this parameter is enabled, the staging and destaging threshold is auto tuned during operation. The settings are optimized to prevent the pressure from overshooting or undershooting when staging and destaging pumps.		
Option:	Function:	
[0] *	Disabled	
[1]	Enabled	

27-41 Ramp Down Delay		
Range:		Function:
10 s*	[0 - 120 s]	Enter the delay between turning on a pump controlled by a soft starter and ramping down a pump controlled by the frequency converter. This parameter is only used for soft starter and star/delta controlled pumps.

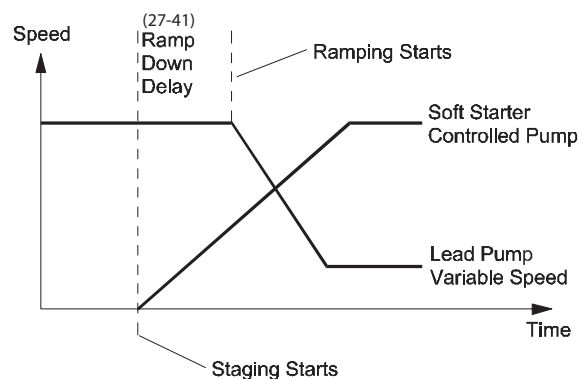

Figure 3.105 Ramp Down Delay

27-42 Ramp Up Delay		
Range:		Function:
2 s*	[0 - 12 s]	Enter the delay between turning off a pump controlled by a soft starter and ramping up a pump controlled by the frequency converter. This parameter is only used for soft starter controlled pumps.
NOTICE! Not used with star/delta controlled pumps.		

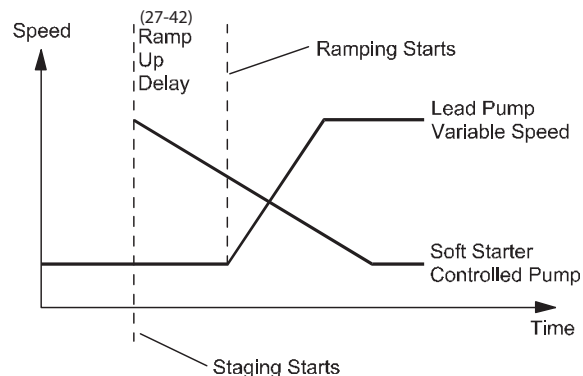
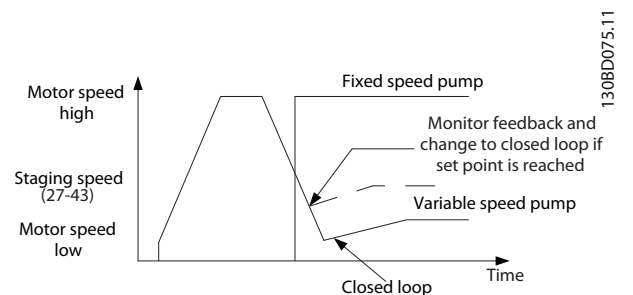

Figure 3.106 Ramp Up Delay

27-43 Staging Threshold		
Range:		Function:
Size related*	[0 - 100 %]	Enter the speed in the staging ramp at which the fixed speed pump is turned on. The value is a percentage of the maximum pump speed. If <i>parameter 27-40 Auto Tune Staging Settings</i> is set to [1] Enabled, <i>parameter 27-43 Staging Threshold</i> and <i>parameter 27-44 Destaging Threshold</i> are kept up to date with the new calculated values. If <i>parameter 27-43 Staging</i>

27-43 Staging Threshold	
Range:	Function:
	Threshold and parameter 27-44 Destaging Threshold are modified via the fieldbus or the LCP, then the new values are used, but are continuously automatically tuned.



1308D075.11

Figure 3.107 Staging Threshold

27-46 Staging Speed [Hz]	
Range:	Function:
0 Hz*	[0 - 0 Hz] Shows the actual staging speed based on the staging threshold.

27-47 Destaging Speed [RPM]	
Range:	Function:
0 RPM*	[0 - 0 RPM] Shows the actual destaging speed based on the destaging threshold.

27-48 Destaging Speed [Hz]	
Range:	Function:
0 Hz*	[0 - 0 Hz] Shows the actual destaging speed based on the destaging threshold.

27-44 Destaging Threshold	
Range:	Function:
Size related* [0 - 100 %]	Enter the speed in the staging ramp at which the fixed speed pump is turned off. The value is a percentage of the maximum pump speed. If parameter 27-40 Auto Tune Staging Settings is set to [1] Enabled, parameter 27-43 Staging Threshold and parameter 27-44 Destaging Threshold are kept up to date with the new calculated values. If parameter 27-43 Staging Threshold and parameter 27-44 Destaging Threshold are modified via the fieldbus or the LCP, then the new values are used, but are continuously automatically tuned.

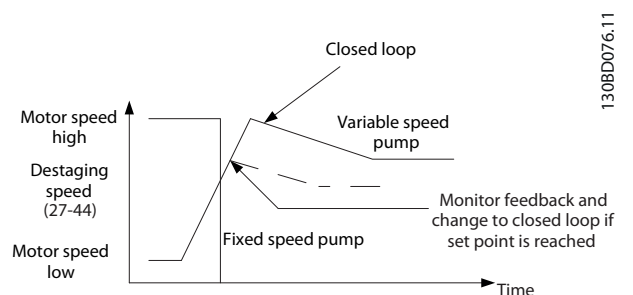

1308D076.11

Figure 3.108 Destaging Threshold

27-45 Staging Speed [RPM]	
Range:	Function:
0 RPM*	[0 - 0 RPM] Shows the actual staging speed based on the staging threshold.

3.24.9 27-5* Alternation Settings

Parameters for configuring the alternation settings.

27-51 Alternation Event		
Select <i>option [1] At Destage</i> to enable alternation at destaging.		
Option:		Function:
[0]	Off	
[1]	At Destage	

27-52 Alternation Time Interval		
Range:		Function:
0 min*	[0 - 10080 min]	Enter the time between alternations. Disable the alternation by entering the value 0. <i>Parameter 27-53 Alternation Timer Value</i> shows the time remaining until the next alternation occurs.

27-53 Alternation Timer Value		
Range:		Function:
0 min*	[0 - 10080 min]	Shows the time remaining before an interval-based alternation occurs. <i>Parameter 27-52 Alternation Time Interval</i> defines the time interval.

27-54 Alternation At Time of Day		
Enable alternating pumps at a specific time of day. The time is set in <i>parameter 27-55 Alternation Predefined Time</i> . This parameter requires the real-time clock.		
Option:		Function:
[0] *	Disabled	
[1]	Enabled	

27-55 Alternation Predefined Time		
Range:		Function:
Size related*	[0 - 0]	Enter the time of day for pump alternation. This parameter is only available if <i>parameter 27-54 Alternation At Time of Day</i> is set to <i>option [1] Enabled</i> .

27-56 Alternate Capacity is <		
Range:		Function:
0 %*	[0 - 100 %]	This parameter ensures that the lead pump is operating at a speed lower than a certain value before the time-based alternation takes place. This ensures that alternation only takes place when the interruption in operation does not affect the quality of the process and minimizes the system disturbance caused by alternations. The value is a percentage of the capacity of pump 1. Setting this parameter to 0% disables it.

27-58 Run Next Pump Delay		
Range:		Function:
0.1 s*	[0.1 - 5 s]	Enter the delay between stopping the current lead pump and starting the next lead pump when alternating lead pumps. This parameter gives the contactors time to switch while both pumps are stopped.

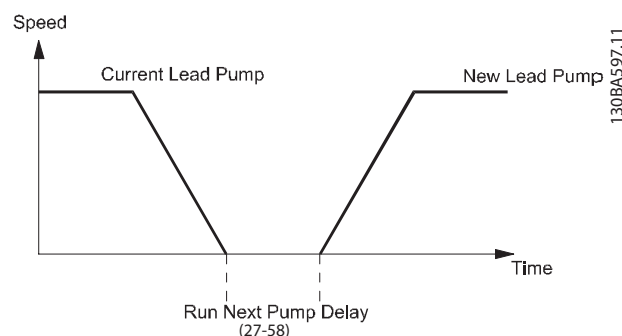

Figure 3.109 Run Next Pump Delay

3.24.10 27-6* Digital Inputs

Parameters for configuring digital inputs. Parameters in this group are only available if *VLT® Advanced Cascade Controller MCO 102* is installed.

27-60 Terminal X66/1 Digital Input		
Select the function for this digital input.		
Option:		Function:
[0] *	No operation	
[1]	Reset	
[2]	Coast inverse	
[3]	Coast and reset inv	
[5]	DC-brake inverse	
[6]	Stop inverse	
[7]	External Interlock	
[8]	Start	
[9]	Latched start	
[10]	Reversing	
[11]	Start reversing	
[14]	Jog	
[15]	Preset reference on	
[16]	Preset ref bit 0	
[17]	Preset ref bit 1	
[18]	Preset ref bit 2	
[19]	Freeze reference	
[20]	Freeze output	
[21]	Speed up	
[22]	Speed down	
[23]	Set-up select bit 0	
[24]	Set-up select bit 1	

27-60 Terminal X66/1 Digital Input	
Select the function for this digital input.	
Option:	Function:
[34]	Ramp bit 0
[36]	Mains failure inverse
[37]	Emergency Mode
[42]	Ref source bit 0
[51]	Hand/Auto Start
[52]	Run permissive
[53]	Hand start
[54]	Auto start
[55]	DigiPot increase
[56]	DigiPot decrease
[57]	DigiPot clear
[62]	Reset Counter A
[65]	Reset Counter B
[66]	Sleep Mode
[75]	MCO Specific
[78]	Reset Preventive Maintenance Word
[80]	PTC Card 1
[85]	Latched Pump Derag
[86]	Flow Confirmation
[87]	Reset Flow Totalized Volume Counter
[88]	Reset Flow Actual Volume Counter
[89]	Reset Derag Counter
[120]	Lead Pump Start
[121]	Lead Pump Alternation
[130]	Pump 1 Interlock
[131]	Pump 2 Interlock
[132]	Pump 3 Interlock
[133]	Pump 4 Interlock
[134]	Pump 5 Interlock
[135]	Pump 6 Interlock
[136]	Pump 7 Interlock
[137]	Pump 8 Interlock
[138]	Pump 9 Interlock

27-61 Terminal X66/3 Digital Input

This parameter contains all options and functions listed in parameter 27-60 Terminal X66/1 Digital Input.

27-62 Terminal X66/5 Digital Input

This parameter contains all options and functions listed in parameter 27-60 Terminal X66/1 Digital Input.

27-63 Terminal X66/7 Digital Input

This parameter contains all options and functions listed in parameter 27-60 Terminal X66/1 Digital Input.

27-64 Terminal X66/9 Digital Input

This parameter contains all options and functions listed in parameter 27-60 Terminal X66/1 Digital Input.

27-65 Terminal X66/11 Digital Input

This parameter contains all options and functions listed in parameter 27-60 Terminal X66/1 Digital Input.

27-66 Terminal X66/13 Digital Input

This parameter contains all options and functions listed in parameter 27-60 Terminal X66/1 Digital Input.

3.24.11 27-7* Connections

Parameters for configuring relay connections.

27-70 Relay

This parameter is only relevant for a relay wiring configuration. Use this parameter to set up the function of the option relays. This parameter is an array. The visibility of options depends on the MCO option installed in the frequency converter:

- VLT® Extended Cascade Controller MCO 101: Relays 10-12 are available.
- VLT® Advanced Cascade Controller MCO 102: Relays 13-20 are available.

In any case, the standard relays (Relay 1 and Relay 2), and the relays in the VLT® Relay Option MCB 105 are available. To set the function of a specific relay, select the relay and then select the function. If the *option [0] Standard Relay* is selected, the relay can be used as a general-purpose relay and the function can be set in *parameter group 5-4* Relays*.

Option:	Function:
[0] *	Standard Relay Enable slave frequency converter X.
[1]	Drive 2 Enable
[2]	Drive 3 Enable
[3]	Drive 4 Enable
[4]	Drive 5 Enable
[5]	Drive 6 Enable
[6]	Drive 7 Enable
[7]	Drive 8 Enable
[8]	Pump 1 to Drive 1
[9]	Pump 1 to Drive 2
[10]	Pump 1 to Drive 3
[11]	Pump 1 to Drive 4
[12]	Pump 1 to Drive 5
[13]	Pump 1 to Drive 6
[14]	Pump 1 to Drive 7
[15]	Pump 1 to Drive 8
[16]	Pump 2 to Drive 1
[17]	Pump 2 to Drive 2
[18]	Pump 2 to Drive 3
[19]	Pump 2 to Drive 4
[20]	Pump 2 to Drive 5
[21]	Pump 2 to Drive 6
[22]	Pump 2 to Drive 7
[23]	Pump 2 to Drive 8
[24]	Pump 3 to Drive 1
[25]	Pump 3 to Drive 2
[26]	Pump 3 to Drive 3
[27]	Pump 3 to Drive 4
[28]	Pump 3 to Drive 5

27-70 Relay

This parameter is only relevant for a relay wiring configuration. Use this parameter to set up the function of the option relays. This parameter is an array. The visibility of options depends on the MCO option installed in the frequency converter:

- VLT® Extended Cascade Controller MCO 101: Relays 10-12 are available.
- VLT® Advanced Cascade Controller MCO 102: Relays 13-20 are available.

In any case, the standard relays (Relay 1 and Relay 2), and the relays in the VLT® Relay Option MCB 105 are available. To set the function of a specific relay, select the relay and then select the function. If the *option [0] Standard Relay* is selected, the relay can be used as a general-purpose relay and the function can be set in *parameter group 5-4* Relays*.

Option:	Function:
[29]	Pump 3 to Drive 6
[30]	Pump 3 to Drive 7
[31]	Pump 3 to Drive 8
[32]	Pump 4 to Drive 1
[33]	Pump 4 to Drive 2
[34]	Pump 4 to Drive 3
[35]	Pump 4 to Drive 4
[36]	Pump 4 to Drive 5
[37]	Pump 4 to Drive 6
[38]	Pump 4 to Drive 7
[39]	Pump 4 to Drive 8
[40]	Pump 5 to Drive 1
[41]	Pump 5 to Drive 2
[42]	Pump 5 to Drive 3
[43]	Pump 5 to Drive 4
[44]	Pump 5 to Drive 5
[45]	Pump 5 to Drive 6
[46]	Pump 5 to Drive 7
[47]	Pump 5 to Drive 8
[48]	Pump 6 to Drive 1
[49]	Pump 6 to Drive 2
[50]	Pump 6 to Drive 3
[51]	Pump 6 to Drive 4
[52]	Pump 6 to Drive 5
[53]	Pump 6 to Drive 6
[54]	Pump 6 to Drive 7
[55]	Pump 6 to Drive 8
[56]	Pump 7 to Drive 1
[57]	Pump 7 to Drive 2
[58]	Pump 7 to Drive 3
[59]	Pump 7 to Drive 4
[60]	Pump 7 to Drive 5
[61]	Pump 7 to Drive 6
[62]	Pump 7 to Drive 7

27-70 Relay		
<p>This parameter is only relevant for a relay wiring configuration. Use this parameter to set up the function of the option relays. This parameter is an array. The visibility of options depends on the MCO option installed in the frequency converter:</p> <ul style="list-style-type: none"> VLT® Extended Cascade Controller MCO 101: Relays 10-12 are available. VLT® Advanced Cascade Controller MCO 102: Relays 13-20 are available. <p>In any case, the standard relays (Relay 1 and Relay 2), and the relays in the VLT® Relay Option MCB 105 are available. To set the function of a specific relay, select the relay and then select the function. If the <i>option [0] Standard Relay</i> is selected, the relay can be used as a general-purpose relay and the function can be set in <i>parameter group 5-4* Relays</i>.</p>		
Option:		Function:
[63]	Pump 7 to Drive 8	
[64]	Pump 8 to Drive 1	
[65]	Pump 8 to Drive 2	
[66]	Pump 8 to Drive 3	
[67]	Pump 8 to Drive 4	
[68]	Pump 8 to Drive 5	
[69]	Pump 8 to Drive 6	
[70]	Pump 8 to Drive 7	
[71]	Pump 8 to Drive 8	
[72]	Pump 1 to Mains	
[73]	Pump 2 to Mains	
[74]	Pump 3 to Mains	
[75]	Pump 4 to Mains	
[76]	Pump 5 to Mains	
[77]	Pump 6 to Mains	
[78]	Pump 7 to Mains	
[79]	Pump 8 to Mains	

27-92 % Of Total Capacity		
Shows the system operating point as a percentage of the total system capacity. 100% means that all pumps are on at full speed.		
Range:		Function:
0 %*	[0 - 0 %]	

27-93 Cascade Option Status		
Shows the status of the cascade system.		
Option:		Function:
[0] *	Disabled	The cascade option is not used.
[1]	Off	The cascade function is turned off.
[2]	Running	The cascade function is running normally.
[3]	Running at FSBW	The cascade function is running in the fixed speed mode. No variable speed pumps are available.
[4]	Jogging	The system is running at the jog speed set in <i>parameter 3-11 Jog Speed [Hz]</i> .
[5]	In Open Loop	The control principle is set to open loop.
[6]	Freezed	The system is frozen in the current state. No changes take place.
[7]	Coast	The system is stopped due to coasting.
[8]	Alarm	The system is operating with an alarm.
[9]	Staging	A staging operation is in progress.
[10]	Destaging	A destaging operation is in progress.
[11]	Alternating	An alternation operation is in progress.
[12]	All Offline	
[13]	Cascade CTL Sleep	

3.24.12 27-9* Readouts

This parameter group contains the cascade controller readout parameters.

27-91 Cascade Reference		
Shows the reference output for the slave frequency converters. This reference is available even when the master frequency converter is stopped. This is the speed that the frequency converter is operating at or would be operating at if it was on. The value is a percentage of <i>parameter 4-13 Motor Speed High Limit [RPM]</i> or <i>parameter 4-14 Motor Speed High Limit [Hz]</i> .		
Range:		Function:
0 %*	[-200 - 200 %]	

27-94 Cascade System Status

This parameter shows the status of each individual pump. The value depends on the wiring configuration.

- Relay wiring configuration:**
 The parameter shows the status of all relays configured in the system. The value has the following format: PUMP_NUMBER:PUMP_STATUS. PUMP_STATUS can have 1 of the following values: 0, R, D, X.
 For example:
 1:D 2:R 3:0 4:X
 D: Variable speed pump. R: Fixed speed pump. 0: Not running. X: Interlock.
- Serial communication wiring configuration:**
 The parameter shows the system status. The value has the following format: MASTER/FOLLOWER:PUMP_STATUS. PUMP_STATUS can have 1 of the following values: 0, D, X.
 For example:
 M:D F:0 F:X
 D: Variable speed pump. 0: Not running. X: Interlock or OFF mode. x: Tripped or no communication.

Range:
Function:

0*	[0 - 25]	
----	-----------	--

27-95 Advanced Cascade Relay Output [bin]
Range: Function:

0*	[0 - 255]	Shows the status of each individual relay. From left to right, the bits correspond to relays 13, 14, 15, 16, 17, 18, 19, 20.
----	------------	--

27-96 Extended Cascade Relay Output [bin]
Range: Function:

0*	[0 - 7]	Shows the status of relay outputs. From left to right, the bits correspond to relay outputs 12, 11, and 10.
----	----------	---

3.25 Parameters 29-** Water Application Functions

The group contains parameters used for monitoring water/wastewater applications.

3.25.1 29-0* Pipe Fill function

In water supply systems, water hammering can occur when filling the pipes too fast. It is therefore desirable to limit the filling rate. Pipe fill mode eliminates the occurrence of water hammering associated with the rapid exhausting of air from the piping system by filling the pipes at a low rate.

This function is used in horizontal, vertical, and mixed piping systems. As the pressure in horizontal pipe systems does not climb as the system fills, filling horizontal pipe systems requires a user-specified speed to fill for a user-specified time and/or until a user-specified pressure setpoint is reached.

The best way to fill a vertical pipe system is to use the PID function to ramp the pressure at a user-specified rate between the motor speed low limit and a user-specified pressure.

The pipe fill function uses a combination of the above to ensure a safe filling of any system.

No matter which system, the pipe fill mode starts using the constant speed set in *parameter 29-01 Pipe Fill Speed [RPM]* until the pipe fill time in *parameter 29-03 Pipe Fill Time* has expired. Filling then continues with the filling ramp set in *parameter 29-04 Pipe Fill Rate* until the filling setpoint specified in *parameter 29-05 Filled Setpoint* is reached.

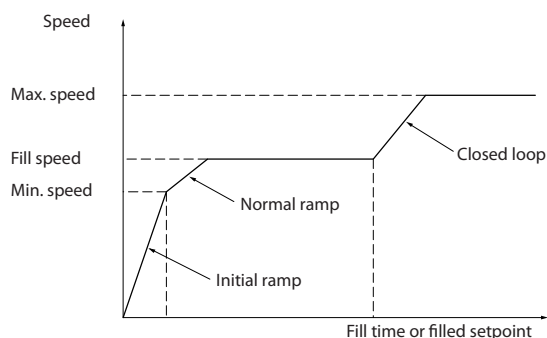

Figure 3.110 Horizontal Pipe System

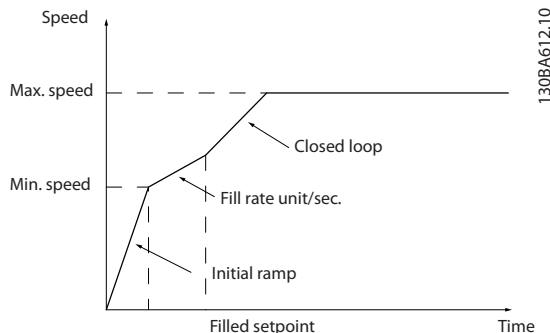

Figure 3.111 Vertical Pipe System

29-00 Pipe Fill Enable		
Option:	Function:	
[0] *	Disabled	Select [1] Enabled to fill pipes at a user-specified rate.
[1]	Enabled	Select [1] Enabled to fill pipes at a user-specified rate.

29-01 Pipe Fill Speed [RPM]		
Range:	Function:	
Size related*	[par. 4-11 - par. 4-13 RPM]	Set the filling speed for filling horizontal pipe systems. The speed can be selected in Hz or RPM depending on the selection made in <i>parameter 4-11 Motor Speed Low Limit [RPM]</i> / <i>parameter 4-13 Motor Speed High Limit [RPM]</i> or in <i>parameter 4-12 Motor Speed Low Limit [Hz]</i> / <i>parameter 4-14 Motor Speed High Limit [Hz]</i> .

29-02 Pipe Fill Speed [Hz]		
Range:	Function:	
Size related*	[par. 4-12 - par. 4-14 Hz]	Set the filling speed for filling horizontal pipe systems. The speed can be selected in Hz or RPM depending on the options selected in <i>parameter 4-11 Motor Speed Low Limit [RPM]</i> / <i>parameter 4-13 Motor Speed High Limit [RPM]</i> or in <i>parameter 4-12 Motor Speed Low Limit [Hz]</i> / <i>parameter 4-14 Motor Speed High Limit [Hz]</i> .

29-03 Pipe Fill Time		
Range:	Function:	
0 s*	[0 - 3600 s]	Set the specified time for pipe filling of horizontal pipe systems.

29-04 Pipe Fill Rate		
Range:	Function:	
0.001 ProcessCtrlUnit*	[0.001 - 999999.999 ProcessCtrlUnit]	Specifies the fill rate in units using the PI controller. Fill rate units are feedback units. This function is used for filling up vertical pipe systems, but is active when the filling time has expired, until the pipe fill setpoint set in <i>parameter 29-05 Filled Setpoint</i> is reached.

29-05 Filled Setpoint		
Range:	Function:	
0 ProcessCtrlUnit*	[-999999.999 - 999999.999 ProcessCtrlUnit]	Specifies the filled setpoint at which the pipe fill function is disabled and the PID controller takes control. This function can be used both for horizontal and vertical pipe systems.

29-06 No-Flow Disable Timer		
Range:	Function:	
0 s*	[0 - 3600 s]	

29-07 Filled setpoint delay		
Range:	Function:	
0 s*	[0 - 10 s]	Select the delay before the frequency converter considers the filled setpoint to be reached if a fill rate in units per second is used.

3.25.2 29-1* Deragging Function

The purpose of the deragging feature is to free the pump blade of debris in waste water applications so that the pump operates normally.

A deragging event is defined as the time when the frequency converter starts to derag to when the deragging finishes. When a derag is started, the frequency converter ramps first to a stop and then an off delay expires before the first cycle begins.

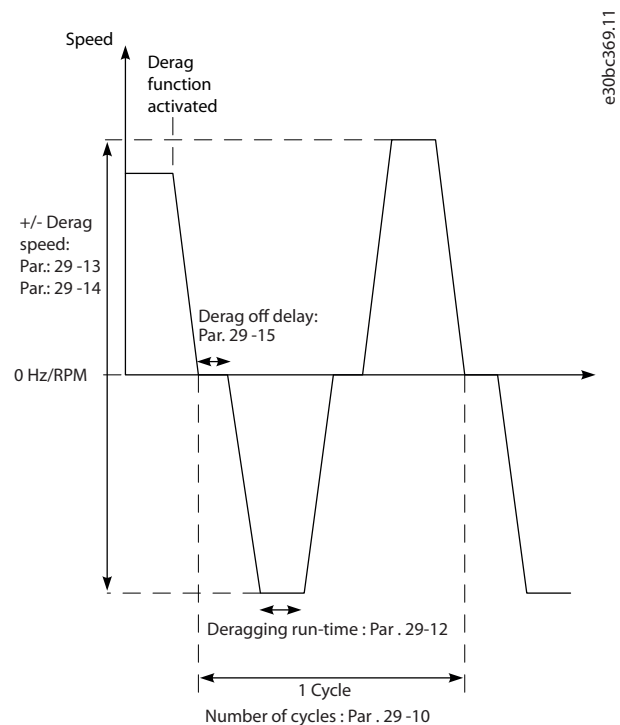

Figure 3.112 Derag Function

If a derag is triggered from a frequency converter-stopped state, the first off delay is skipped. The deragging event may consist of several cycles: one cycle consisting of 1 pulse in the reverse direction followed by 1 pulse in the forward direction. Deragging is considered finished after the specified number of cycles have completed. More specifically, on the last pulse (it is always forward) of the last cycle, the derag is considered finished after the deragging run-time expires (the frequency converter is running at derag speed). In between pulses, the frequency converter output coasts for a specified off-delay time to let debris in the pump settle.

NOTICE!

Do not enable deragging if the pump cannot operate in reverse direction.

There are 3 different notifications for an ongoing deragging event:

- Status in the LCP: *Auto Remote Derag*.
- A bit in the extended status word (bit 23, 80 0000 hex).
- A digital output can be configured to reflect the active deragging status.

Depending on the application and the purpose of using it, this feature can be used as a preventive or reactive measure and can be triggered/started in the following ways:

- On each start command (*parameter 29-11 Derag at Start/Stop*).
- On each stop command (*parameter 29-11 Derag at Start/Stop*).
- On each start/stop command (*parameter 29-11 Derag at Start/Stop*).
- On digital input (*parameter group 5-1* Digital Inputs*).
- On frequency converter action with the smart logic controller (*parameter 13-52 SL Controller Action*).
- As timed action (*parameter group 23-** Time-based Functions*).
- On high power (*parameter group 29-2* Derag Power Tuning*).

29-10 Derag Cycles		
Range:	Function:	
Size related*	[0 - 10]	The number of cycles the frequency converter derags.

29-11 Derag at Start/Stop		
Option:	Function:	
		Derag function when starting and stopping the frequency converter.
[0] *	Off	
[1]	Start	
[2]	Stop	
[3]	Start and stop	

29-12 Deragging Run Time		
Range:	Function:	
0 s*	[0 - 3600 s]	The time that the frequency converter dwells at the derag speed.

29-13 Derag Speed [RPM]		
Range:	Function:	
Size related*	[0 - par. 4-13 RPM]	The speed at which the frequency converter derags in RPM.

29-14 Derag Speed [Hz]		
Range:	Function:	
Size related*	[0.0 - par. 4-14 Hz]	The speed at which the frequency converter derags in Hz.

29-15 Derag Off Delay		
Range:	Function:	
10 s*	[1 - 600 s]	The time that the frequency converter remains off before starting another derag pulse. Allows contents of the pump to settle.

29-16 Derag Counter		
Range:	Function:	
0*	[0 - 2147483647]	Shows the number of deragging events.

29-17 Reset Derag Counter		
Option:	Function:	
[0] *	Do not reset	
[1]	Reset counter	Select option [1] <i>Reset counter</i> to reset the deragging counter.

3.25.3 29-2* Derag Power Tuning

The derag feature monitors frequency converter power in a similar fashion as no-flow. Based on 2 user-defined points and an offset value, the monitor calculates a derag power curve. It uses the exact same calculations as no-flow with the difference being that derag monitors for high power and not low power.

Commissioning the no-flow user points via the no-flow auto set-up also sets the points of the derag curve to the same value.

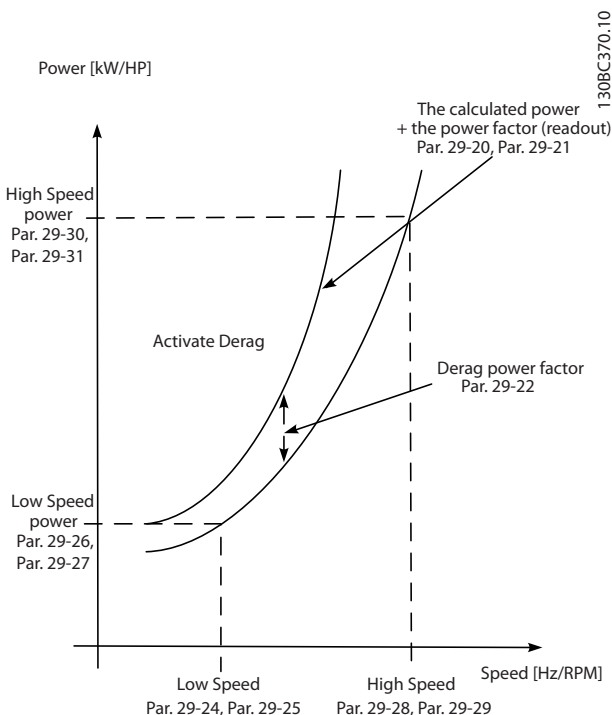

Figure 3.113 Derag Power Tuning

29-20 Derag Power[kW]		
Range:	Function:	
0 kW*	[0 - 0 kW]	Readout of calculated derag power at actual speed.

29-21 Derag Power[HP]		
Range:	Function:	
0 hp*	[0 - 0 hp]	Readout of calculated derag power at actual speed.

29-22 Derag Power Factor		
Range:	Function:	
200 %*	[1 - 400 %]	Set a correction if derag detection reacts on too low a power value.

29-23 Derag Power Delay		
Range:	Function:	
601 s*	[1 - 601 s]	The time that the frequency converter must remain on reference and a high-power condition for a derag to occur.

29-24 Low Speed [RPM]		
Range:	Function:	
Size related*	[0 - par. 29-28 RPM]	Set output speed used for registration of derag power at low speed in RPM.

29-25 Low Speed [Hz]		
Range:	Function:	
Size related*	[0 - par. 29-29 Hz]	Set output speed used for registration of derag power at low speed in Hz.

29-26 Low Speed Power [kW]		
Range:	Function:	
Size related*	[0 - 5.50 kW]	Set derag power at low speed in kW.

29-27 Low Speed Power [HP]		
Range:	Function:	
Size related*	[0 - 7.50 hp]	Set derag power at low speed in hp.

29-28 High Speed [RPM]		
Range:	Function:	
Size related*	[0.0 - par. 4-13 RPM]	Set output speed used for registration of derag power at high speed in RPM.

29-29 High Speed [Hz]		
Range:	Function:	
Size related*	[0.0 - par. 4-14 Hz]	Set output speed used for registration of derag power at high speed in Hz.

29-30 High Speed Power [kW]		
Range:	Function:	
Size related*	[0 - 5.50 kW]	Set derag power at high speed in kW.

29-31 High Speed Power [HP]		
Range:	Function:	
Size related*	[0 - 7.50 hp]	Set derag power at high speed in hp.

29-32 Derag On Ref Bandwidth		
Range:	Function:	
5 %*	[1 - 100 %]	Set the bandwidth percentage of motor speed high limit to accommodate system pressure fluctuation.

29-33 Power Derag Limit		
Range:	Function:	
3*	[0 - 10]	The number of times the power monitor can trigger consecutive derags before a fault is reported.

29-34 Consecutive Derag Interval		
Range:	Function:	
Size related*	[Size related]	Derags are considered to be consecutive if they happen within the interval specified in this parameter.

3.25.4 29-4* Pre/Post-Lube Function

Use the pre/post-lube function in the following applications:

- A motor requires lubrication of its mechanical parts before and while it runs to prevent damage and wear. This is especially the case when the motor has not been running for a long time.
- An application requires external fans to run.

The function makes the frequency converter signal an external device for a user-defined period. A start delay can be configured with *parameter 1-71 Start Delay*. With this delay, the pre-lube function runs while the motor is stopped.

For information about the pre/post lube function options, see the following parameters:

- *Parameter 29-40 Pre/Post Lube Function.*
- *Parameter 29-41 Pre Lube Time.*
- *Parameter 29-42 Post Lube Time.*

Consider the following use case:

- A lubricating device starts the lubrication at the time when the frequency converter receives the start command.
- The frequency converter starts the motor. The lubrication device is still running.
- After a certain time, the frequency converter stops the lubrication device.

See *Figure 3.114*.

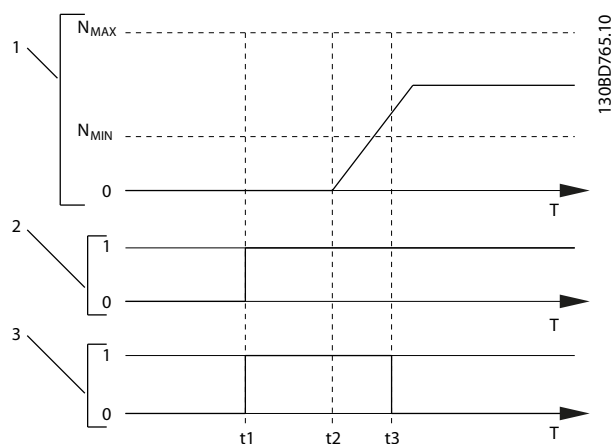

1	Speed curve
2	Start command (for example terminal 18)
3	Pre-lube output signal
t ₁	Start command issued (for example terminal 18 is set active). The start delay timer (<i>parameter 1-71 Start Delay</i>) and the pre-lube timer (<i>parameter 29-41 Pre Lube Time</i>).
t ₂	The start delay timer expires. The frequency converter starts to ramp up.
t ₃	The pre-lube timer (<i>parameter 29-41 Pre Lube Time</i>) expires.

Figure 3.114 Pre/Post Lube Function Example

29-40 Pre/Post Lube Function		
Select when the pre/post-lube function is active. Use <i>parameter 1-71 Start Delay</i> to set the delay before the frequency converter starts to ramp up.		
Option:	Function:	
[0] *	Disabled	
[1]	Pre Lube Only	
[2]	Pre & Running	
[3]	Pre & Running & Post	

29-41 Pre Lube Time		
Range:	Function:	
10 s*	[0 - 600 s]	Enter how long the pre-lube function is active. Use only when option [1] <i>Pre Lube Only</i> is selected in <i>parameter 29-40 Pre/Post Lube Function</i> .

29-42 Post Lube Time		
Range:	Function:	
10 s*	[0 - 600 s]	Enter how long the post-lube function is on after the motor stops. Use only when option [3] <i>Pre & Running & Post</i> is selected in <i>parameter 29-40 Pre/Post Lube Function</i> .

3.25.5 29-5* Flow Confirmation

The flow confirmation feature is designed for applications where there is a need for the motor/pump to run while waiting for an external event. The flow confirmation monitor expects to receive a digital input from a sensor on a gate valve, flow switch, or a similar external device, indicating that the device is in the open position and flow is possible. In *parameter 29-50 Validation Time*, define for how long the VLT® AQUA Drive FC 202 waits for the digital input signal from the external device to confirm the flow. After the flow is confirmed, the frequency converter checks the signal again after the flow verification time and then runs normally. The LCP status reads *Verifying flow* while the flow monitor is active.

The frequency converter trips with the alarm *Flow Not Confirmed* if the expected digital input signal becomes inactive before either the flow validation time or the flow verification time expires.

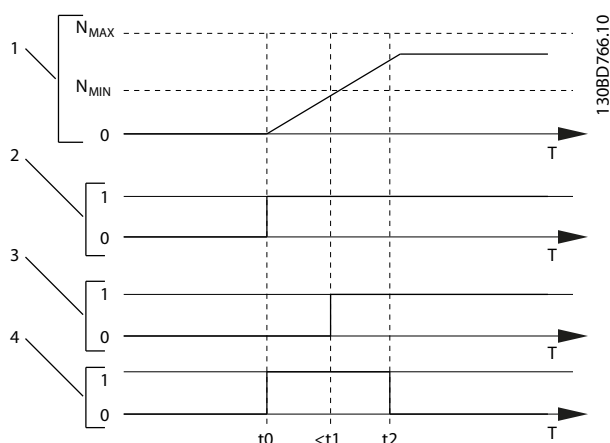

1	Speed curve.
2	Start command (for example, terminal 18).
3	Digital signal from an external device that confirms that the flow is possible.
4	Flow verification.
t ₀	Start command issued (for example, terminal 18 is set active).
t ₁	Digital signal from an external device becomes active before <i>parameter 29-50 Validation Time</i> expires.
t ₂	When <i>parameter 29-51 Verification Time</i> passes, the frequency converter checks the signal from the external device again and then runs normally.

Figure 3.115 Flow Confirmation

29-50 Validation Time		
Range:	Function:	
Size related*	[0 - 999 s]	NOTICE! <i>Parameter 29-50 Validation Time is only visible in the LCP if a digital input is set to [86] Flow Confirmation (see parameter group 5-1* Digital Inputs).</i> The digital input from an external device must be active during the validation time.

29-51 Verification Time		
Range:	Function:	
15 s*	[0.10 - 255 s]	NOTICE! <i>Parameter 29-51 Verification Time is only visible in the LCP if a digital input is set to [86] Flow Confirmation (see parameter group 5-1* Digital Inputs).</i> When the time in this parameter passes, the frequency converter checks the signal from the external device. If the signal is active, the frequency converter runs normally.

29-52 Signal Lost Verification Time		
Enter the length of the delay after which the signal is considered to be lost. This parameter is ignored if <i>parameter 29-53 Flow Confirmation Mode</i> is set to [0] Confirmation Only.		
Range:	Function:	
1 s*	[0.01 - 255 s]	

29-53 Flow Confirmation Mode		
Select the operating mode of the flow monitor function.		
Option:	Function:	
[0] *	Confirmation Only	The flow confirmation function is only active during the start-up of the pump.
[1]	Monitor and Stop	The flow confirmation function is active during and after the pump start-up. The frequency converter performs a ramp down to a stop if the input signal is lost.
[2]	Monitor and Coast	The flow confirmation function is active during and after the pump start-up. The frequency converter performs coasting if the input signal is lost.

3.25.6 29-6* Flow Meter

VLT® AQUA Drive FC 202 can measure the flow in the system. Irrigation applications is the most common use case for parameters in this parameter group. The functionality allows to:

- Measure the flow in the system.
- Calculate the water volume pumped for a period of time.
- React on flow conditions (for example, low flow rate).
- Control the system using the pumped water volume calculated by the frequency converter (for example, stop pumping when a certain amount of water is pumped, cyclic pumping of water volumes).
- Utilize the output signal of an external flow meter that is connected to an input of the frequency converter.

Inputs and supported signal types

The flow meter feature can use and scale the output signals of commonly used flow meters. The feature supports the following signal types:

- Current: 0/4–20 mA.
- Voltage: 0–10 V.
- Pulse signal (for example: paddle wheel flow meters).

Configure the scaling of the flow meter signal received as input via the available parameters for the input configuration (parameters in *parameter group 6-** Analog In/Out*, or *5-5* Pulse Input*). The flow meter feature also supports inputs of hardware options.

Volume counters

The flow meter feature uses 2 different counters for storing the calculated volume of pumped water:

- *Parameter 29-66 Actual Volume*: See the volume of water pumped since the last counter reset.
- *Parameter 29-65 Totalized Volume*: See the volume of water pumped since the last counter reset. Use this parameter for the total volume of water pumped.

The 2 counters can have different units. Use *parameter 29-66 Actual Volume* for shorter periods of time.

Each parameter can be reset individually in 1 of the following ways:

- Using *parameter 29-67 Reset Totalized Volume* or *parameter 29-68 Reset Actual Volume*.
- Using a digital input.

- Using an action of the smart logic controller.

Reading the data

The measured data is available via readout parameters:

- *Parameter 29-65 Totalized Volume*.
- *Parameter 29-66 Actual Volume*.
- *Parameter 29-69 Flow*.

To show the readout parameters on the LCP, configure the display lines. Comparator operands can use the data from readout parameters as conditions for SLC, and as triggers for actions. The measured flow can also be used as input for the feedback.

NOTICE!

This software feature has not been designed as being part of a calibrated measurement system. The overall accuracy also depends on external factors such as flow conditions and used flow meter. See the *design guide* for details about analog and digital inputs of the frequency converter.

Examples

- A sequence of SLC is triggered (or stopped) after a specific amount of water is pumped.
- The frequency converter performs 1 or more actions and resets the volume counters within a sequence of SLC.
- An alert shows up after a specific amount of water is pumped.

29-60 Flow Meter Monitor		
Enable the flow meter monitor.		
Option:	Function:	
[0] *	Disabled	
[1]	Enabled	
[2]	Enabled While Running	Enable the monitor only when the connected pump is running.

29-61 Flow Meter Source		
Select the source for the flow meter signal. Available options depend on the hardware configuration.		
Option:	Function:	
[0] *	Analog Input 53	
[1]	Analog Input 54	
[2]	Analog Input X30/11	
[3]	Analog Input X30/12	
[4]	Analog Input X42/1	
[5]	Analog Input X42/3	
[6]	Analog Input X42/5	
[7]	Analog Input X48/2	
[8]	Pulse Input 29	
[9]	Pulse Input 33	

29-61 Flow Meter Source		
Select the source for the flow meter signal. Available options depend on the hardware configuration.		
Option:	Function:	
[10]	Bus Feedback 1	
[11]	Bus Feedback 2	
[12]	Bus Feedback 3	

29-62 Flow Meter Unit		
Select the unit for the flow meter output.		
Option:	Function:	
[0] *	l/s	
[1]	l/min	
[2]	l/h	
[3]	m ³ /s	
[4]	m ³ /min	
[5]	m ³ /h	
[6]	gal/s	
[7]	gal/min	
[8]	gal/h	
[9]	in ³ /s	
[10]	in ³ /min	
[11]	in ³ /h	
[12]	ft ³ /s	
[13]	ft ³ /min	
[14]	ft ³ /h	

29-63 Totalized Volume Unit		
Select the unit for <i>parameter 29-65 Totalized Volume</i> .		
Option:	Function:	
[0] *	Disabled	
[1]	l	
[2]	m ³	
[3]	gal	
[4]	in ³	
[5]	ft ³	
[6]	acre-in	
[7]	acre-ft	

29-64 Actual Volume Unit		
Select the unit for <i>parameter 29-66 Actual Volume</i> .		
Option:	Function:	
[0] *	Disabled	
[1]	l	
[2]	m ³	
[3]	gal	
[4]	in ³	
[5]	ft ³	
[6]	acre-in	
[7]	acre-ft	

29-65 Totalized Volume		
Shows the total volume of pumped water.		
Range:	Function:	
0 TotalizedVolumeUnit*	[0 - 2147483647 Totalized-VolumeUnit]	

29-66 Actual Volume		
Shows the volume of pumped water for a period of time.		
Range:	Function:	
0.00 ActualVolumeUnit*	[0.00 - 21474836.47 Actual-VolumeUnit]	

29-67 Reset Totalized Volume		
Set <i>parameter 29-65 Totalized Volume</i> to 0.		
Option:	Function:	
[0] *	Do not reset	
[1]	Do reset	

29-68 Reset Actual Volume		
Set <i>parameter 29-66 Actual Volume</i> to 0.		
Option:	Function:	
[0] *	Do not reset	
[1]	Do reset	

29-69 Flow		
Shows the actual flow rate.		
Range:	Function:	
0 FlowMeterUnit*	[0 - 2147483647 FlowMeterUnit]	

3.26 Parameters 30-** Special Features

3.26.1 30-2* Adv. Start Adjust

30-22 Locked Rotor Detection		
Turn the locked rotor detection on or off. Available only for PM motors in VVC ⁺ .		
Option: Function:		
[0]	Off	
[1]	On	Protects the motor from the locked-rotor condition. The control algorithm detects a possible locked-rotor condition in the motor and trips the frequency converter to protect the motor.

30-23 Locked Rotor Detection Time [s]		
Range:		Function:
Size related*	[0.05 - 1 s]	Enter the time period for detecting the locked-rotor condition. A low parameter value provides faster detection.

3.26.2 30-8* Compatibility

30-81 Brake Resistor (ohm)		
Range:		Function:
50. Ohm*	[5. - 32000.0 Ohm]	Set the brake resistor value in Ω with 2 decimals. This value is used for monitoring the power to the brake resistor in <i>parameter 2-13 Brake Power Monitoring</i> .

3.26.3 30-9* Wifi LCP

Parameters for configuring the wireless LCP 103.

30-90 SSID		
Range:		Function:
Size related*	[1 - 32]	Enter the wireless network name (SSID). The default value is: Danfoss_<Serial number of the frequency converter>. The serial number is in <i>parameter 15-51 Adj Freq Dr Serial No.</i>

30-91 Channel		
Range:		Function:
5*	[1 - 11]	Enter the wireless channel number. The default channel number is 5. Change the channel number, if there is an interference from other wireless networks. Recommended channels: USA territory: 1, 6, 11. Europe: 1, 7, 13.

30-92 Password		
Range:		Function:
Size related*	[8 - 48]	Enter the wireless network password. Password length: 8-48 characters.

30-97 Wifi Timeout Action		
Select which action to execute if a local reference (hand-on mode) or a remote reference (auto-on mode) is set via the wireless connection and the connection is lost.		
Option:		Function:
[0] *	Do Nothing	The frequency converter does not do any extra actions.
[1]	Stop Motor	The frequency converter stops the motor (if the motor was started via a wireless connection).

3.27 Parameters 31-** Bypass Option

Parameter group for the configuration of the electronically controlled bypass option board, VLT® Bypass Option MCO 104.

31-00 Bypass Mode		
Option:	Function:	
[0] *	Drive	Select the operating mode of the bypass: The frequency converter operates the motor.
[1]	Bypass	The motor can be run at full speed in bypass mode.

31-01 Bypass Start Time Delay		
Range:	Function:	
30 s*	[0 - 60 s]	Set the time delay within the time when the bypass receives a run command and the time when it starts the motor at full speed. A countdown timer shows the time left.

31-02 Bypass Trip Time Delay		
Range:	Function:	
0 s*	[0 - 300 s]	Set the time delay within the time that the frequency converter experiences an alarm that stops it and the time when the motor is automatically switched to bypass control. If the time delay is set to 0, a frequency converter alarm does not automatically switch the motor to bypass control.

31-03 Test Mode Activation		
Option:	Function:	
[0] *	Disabled	Test mode is disabled.
[1]	Enabled	The motor runs in bypass, while the frequency converter can be tested in an open circuit. In this mode, the LCP does not control start/stop of the bypass.

31-10 Bypass Status Word		
Range:	Function:	
0*	[0 - 65535]	Views the status of the bypass as a hexadecimal value.

31-11 Bypass Running Hours		
Range:	Function:	
0 h*	[0 - 2147483647 h]	Views the number of hours in which the motor has run in bypass mode. The counter can be reset in <i>parameter 15-07 Reset Running Hours Counter</i> . The value is saved, when the frequency converter is turned off.

31-19 Remote Bypass Activation		
Option:	Function:	
[0] *	Disabled	
[1]	Enabled	

3.28 Parameters 35-** Sensor Input Option

3.28.1 35-0* Temp. Input Mode (MCB 114)

35-00 Term. X48/4 Temperature Unit		
Select the unit to be used with temperature input X48/4 settings and readouts:		
Option:	Function:	
[60] *	°C	
[160]	°F	

35-01 Term. X48/4 Input Type		
View the temperature sensor type detected at input X48/4:		
Option:	Function:	
[0] *	Not Connected	
[1]	PT100 2-wire	
[3]	PT1000 2-wire	
[5]	PT100 3-wire	
[7]	PT1000 3-wire	

35-02 Term. X48/7 Temperature Unit		
Select the unit to be used with temperature input X48/7 settings and readouts:		
Option:	Function:	
[60] *	°C	
[160]	°F	

35-03 Term. X48/7 Input Type		
View the temperature sensor type detected at input X48/7:		
Option:	Function:	
[0] *	Not Connected	
[1]	PT100 2-wire	
[3]	PT1000 2-wire	
[5]	PT100 3-wire	
[7]	PT1000 3-wire	

35-04 Term. X48/10 Temperature Unit		
Select the unit to be used with temperature input X48/10 settings and readouts:		
Option:	Function:	
[60] *	°C	
[160]	°F	

35-05 Term. X48/10 Input Type		
View the temperature sensor type detected at input X48/10:		
Option:	Function:	
[0] *	Not Connected	
[1]	PT100 2-wire	
[3]	PT1000 2-wire	
[5]	PT100 3-wire	
[7]	PT1000 3-wire	

35-06 Temperature Sensor Alarm Function		
Select the alarm function:		
Option:	Function:	
[0]	Off	
[2]	Stop	
[5] *	Stop and trip	
[27]	Forced stop and trip	

3.28.2 35-1* Temp. Input X48/4 (MCB 114)

35-14 Term. X48/4 Filter Time Constant		
Range:	Function:	
0.005 s* [0.005 - 10 s]	Enter the filter time constant. This is a first-order digital low-pass filter time constant for suppressing electrical noise in terminal X48/4. A high time constant value improves dampening, but also increases the time delay through the filter.	

35-15 Term. X48/4 Temp. Monitor		
This parameter gives the possibility of enabling or disabling the temperature monitor for terminal X48/4. The temperature limits can be set in <i>parameter 35-16 Term. X48/4 Low Temp. Limit</i> and <i>parameter 35-17 Term. X48/4 High Temp. Limit</i> .		
Option:	Function:	
[0] *	Disabled	
[1]	Enabled	

35-16 Term. X48/4 Low Temp. Limit		
Enter the minimum temperature reading that is expected for normal operation of the temperature sensor at terminal X48/4.		
Range:	Function:	
Size related*	[-50 - par. 35-17]	

35-17 Term. X48/4 High Temp. Limit		
Enter the maximum temperature reading that is expected for normal operation of the temperature sensor at terminal X48/4.		
Range:	Function:	
Size related*	[par. 35-16 - 204]	

3.28.3 35-2* Temp. Input X48/7 (MCB 114)

35-24 Term. X48/7 Filter Time Constant		
Range:	Function:	
0.005 s* [0.005 - 10 s]	Enter the filter time constant. This is a first-order digital low-pass filter time constant for suppressing electrical noise in terminal X48/7. A high time constant value improves dampening, but also	

35-24 Term. X48/7 Filter Time Constant		
Range:		Function:
		increases the time delay through the filter.

35-25 Term. X48/7 Temp. Monitor		
This parameter gives the possibility of enabling or disabling the temperature monitor for terminal X48/7. The temperature limits can be set in <i>parameter 35-26 Term. X48/7 Low Temp. Limit</i> and <i>parameter 35-27 Term. X48/7 High Temp. Limit</i> .		
Option:		Function:
[0] *	Disabled	
[1]	Enabled	

35-26 Term. X48/7 Low Temp. Limit		
Range:		Function:
Size related*	[-50 - par. 35-27]	Enter the minimum temperature reading that is expected for normal operation of the temperature sensor at terminal X48/7.

35-27 Term. X48/7 High Temp. Limit		
Range:		Function:
Size related*	[par. 35-26 - 204]	Enter the maximum temperature reading that is expected for normal operation of the temperature sensor at terminal X48/7.

3.28.4 35-3* Temp. Input X48/10 (MCB 114)

35-34 Term. X48/10 Filter Time Constant		
Range:		Function:
0.005 s*	[0.005 - 10 s]	Enter the filter time constant. This is a first-order digital low-pass filter time constant for suppressing electrical noise in terminal X48/10. A high time constant value improves dampening, but also increases the time delay through the filter.

35-35 Term. X48/10 Temp. Monitor		
This parameter gives the possibility of enabling or disabling the temperature monitor for terminal X48/10. The temperature limits can be set in <i>parameter 35-36 Term. X48/10 Low Temp. Limit/parameter 35-37 Term. X48/10 High Temp. Limit</i> .		
Option:		Function:
[0] *	Disabled	
[1]	Enabled	

35-36 Term. X48/10 Low Temp. Limit		
Enter the minimum temperature reading that is expected for normal operation of the temperature sensor at terminal X48/10.		
Range:		Function:
Size related*	[-50 - par. 35-37]	

35-37 Term. X48/10 High Temp. Limit		
Enter the maximum temperature reading that is expected for normal operation of the temperature sensor at terminal X48/10.		
Range:		Function:
Size related*	[par. 35-36 - 204]	

3.28.5 35-4* Analog Input X48/2 (MCB 114)

35-42 Term. X48/2 Low Current		
Range:		Function:
4 mA*	[0 - par. 35-43 mA]	Enter the current (mA) that corresponds to the low reference value, set in <i>parameter 35-44 Term. X48/2 Low Ref./Feedb. Value</i> . Set the value at >2 mA to activate the live-zero timeout function in <i>parameter 6-01 Live Zero Timeout Function</i> .

35-43 Term. X48/2 High Current		
Range:		Function:
20 mA*	[par. 35-42 - 20 mA]	Enter the current (mA) that corresponds to the high reference value (set in <i>parameter 35-45 Term. X48/2 High Ref./Feedb. Value</i>).

35-44 Term. X48/2 Low Ref./Feedb. Value		
Range:		Function:
0 ReferenceFeed-backUnit*	[-999999.999 - 999999.999 ReferenceFeed-backUnit]	Enter the reference or feedback value (in RPM, Hz, bar, and so on) that corresponds to the voltage or current set in <i>parameter 35-42 Term. X48/2 Low Current</i> .

35-45 Term. X48/2 High Ref./Feedb. Value		
Range:		Function:
100 Reference-FeedbackUnit*	[-999999.999 - 999999.999 ReferenceFeed-backUnit]	Enter the reference or feedback value (in RPM, Hz, bar, and so on) that corresponds to the voltage or current set in <i>parameter 35-43 Term. X48/2 High Current</i> .

35-46 Term. X48/2 Filter Time Constant		
Range:		Function:
0.005 s*	[0.005 - 10 s]	Enter the filter time constant. This is a first-order digital low-pass filter time constant for suppressing electrical noise in terminal X48/2. A high time constant value improves dampening, but also increases the time delay through the filter.

35-47 Term. X48/2 Live Zero		
This parameter makes it possible to enable the live zero monitoring.		
Option:	Function:	
[0]	Disabled	
[1] *	Enabled	

4 Parameter Lists

4.1 Parameter Options

4.1.1 Default Settings

4

Changes during operation

TRUE means that the parameter can be changed while the frequency converter is in operation. FALSE means that the frequency converter must be stopped before a change can be made.

4-set-up

All set-ups: The parameter can be set individually in each of the 4 set-ups, that is 1 single parameter can have 4 different data values.

1 set-up: Data value is the same in all set-ups.

N/A

No default value available.

Conversion index

This number refers to a conversion figure used when writing or reading via a frequency converter.

Conv. index	100	75	74	70	67	6	5	4	3	2	1	0	-1	-2	-3	-4	-5	-6
Conv. factor	1	3600000	3600	60	1/60	1000000	100000	10000	1000	100	10	1	0.1	0.01	0.001	0.0001	0.00001	0.000001

Table 4.1 Conversion Index

Data type	Description	Type
2	Integer 8	Int8
3	Integer 16	Int16
4	Integer 32	Int32
5	Unsigned 8	UInt8
6	Unsigned 16	UInt16
7	Unsigned 32	UInt32
9	Visible String	VisStr
33	Normalized value 2 bytes	N2
35	Bit sequence of 16 boolean variables	V2
54	Time difference w/o date	TimD

Table 4.2 Conversion Index Description

4.1.2 0-** Operation/Display

Parameter #	Parameter description	Default value	4 set-up	Change during operation	Conversion index	Type
0-0* Basic Settings						
0-01	Language	[0] English	1 set-up	TRUE	-	UInt8
0-02	Motor Speed Unit	[0] RPM	2 set-ups	FALSE	-	UInt8
0-03	Regional Settings	[0] International	2 set-ups	FALSE	-	UInt8
0-04	Operating State at Power-up	[0] Resume	All set-ups	TRUE	-	UInt8
0-05	Local Mode Unit	[0] As Motor Speed Unit	2 set-ups	FALSE	-	UInt8
0-1* Set-up Operations						
0-10	Active Set-up	[1] Set-up 1	1 set-up	TRUE	-	UInt8
0-11	Programming Set-up	[9] Active Set-up	All set-ups	TRUE	-	UInt8
0-12	This Set-up Linked to	[0] Not linked	All set-ups	FALSE	-	UInt8
0-13	Readout: Linked Set-ups	0 N/A	All set-ups	FALSE	0	UInt16
0-14	Readout: Prog. Set-ups/Channel	0 N/A	All set-ups	TRUE	0	Int32
0-2* LCP Display						
0-20	Display Line 1.1 Small	1601	All set-ups	TRUE	-	UInt16
0-21	Display Line 1.2 Small	1662	All set-ups	TRUE	-	UInt16
0-22	Display Line 1.3 Small	1614	All set-ups	TRUE	-	UInt16
0-23	Display Line 2 Large	1613	All set-ups	TRUE	-	UInt16
0-24	Display Line 3 Large	1652	All set-ups	TRUE	-	UInt16
0-25	My Personal Menu	ExpressionLimit	1 set-up	TRUE	0	UInt16
0-3* LCP Custom Readout						
0-30	Custom Readout Unit	[1] %	All set-ups	TRUE	-	UInt8
0-31	Custom Readout Min Value	ExpressionLimit	All set-ups	TRUE	-2	Int32
0-32	Custom Readout Max Value	100 CustomReadoutUnit	All set-ups	TRUE	-2	Int32
0-37	Display Text 1	0 N/A	1 set-up	TRUE	0	VisStr[25]
0-38	Display Text 2	0 N/A	1 set-up	TRUE	0	VisStr[25]
0-39	Display Text 3	0 N/A	1 set-up	TRUE	0	VisStr[25]
0-4* LCP Keypad						
0-40	[Hand on] Key on LCP	[1] Enabled	All set-ups	TRUE	-	UInt8
0-41	[Off] Key on LCP	[1] Enabled	All set-ups	TRUE	-	UInt8
0-42	[Auto on] Key on LCP	[1] Enabled	All set-ups	TRUE	-	UInt8
0-43	[Reset] Key on LCP	[1] Enabled	All set-ups	TRUE	-	UInt8
0-44	[Off/Reset] Key on LCP	[1] Enabled	All set-ups	TRUE	-	UInt8
0-45	[Drive Bypass] Key on LCP	[1] Enabled	All set-ups	TRUE	-	UInt8
0-5* Copy/Save						
0-50	LCP Copy	[0] No copy	All set-ups	FALSE	-	UInt8
0-51	Set-up Copy	[0] No copy	All set-ups	FALSE	-	UInt8
0-6* Password						
0-60	Main Menu Password	100 N/A	1 set-up	TRUE	0	Int16
0-61	Access to Main Menu w/o Password	[0] Full access	1 set-up	TRUE	-	UInt8
0-65	Personal Menu Password	200 N/A	1 set-up	TRUE	0	UInt16
0-66	Access to Personal Menu w/o Password	[0] Full access	1 set-up	TRUE	-	UInt8
0-67	Bus Password Access	0 N/A	All set-ups	TRUE	0	UInt16
0-7* Clock Settings						
0-70	Date and Time	ExpressionLimit	All set-ups	TRUE	0	TimeOfDay

Parameter #	Parameter description	Default value	4 set-up	Change during operation	Conversion index	Type
0-71	Date Format	ExpressionLimit	1 set-up	TRUE	-	UInt8
0-72	Time Format	ExpressionLimit	1 set-up	TRUE	-	UInt8
0-74	DST/Summertime	[0] Off	1 set-up	TRUE	-	UInt8
0-76	DST/Summertime Start	ExpressionLimit	1 set-up	TRUE	0	TimeOfDay
0-77	DST/Summertime End	ExpressionLimit	1 set-up	TRUE	0	TimeOfDay
0-79	Clock Fault	ExpressionLimit	1 set-up	TRUE	-	UInt8
0-81	Working Days	ExpressionLimit	1 set-up	TRUE	-	UInt8
0-82	Additional Working Days	ExpressionLimit	1 set-up	TRUE	0	TimeOfDay
0-83	Additional Non-Working Days	ExpressionLimit	1 set-up	TRUE	0	TimeOfDay
0-89	Date and Time Readout	0 N/A	All set-ups	TRUE	0	VisStr[25]

4.1.3 1-** Load and Motor

Parameter #	Parameter description	Default value	4 set-up	Change during operation	Conversion index	Type
1-0* General Settings						
1-00	Configuration Mode	ExpressionLimit	All set-ups	TRUE	-	Uint8
1-01	Motor Control Principle	[1] VVC+	All set-ups	FALSE	-	Uint8
1-03	Torque Characteristics	[3] Auto Energy Optim. VT	All set-ups	TRUE	-	Uint8
1-04	Overload Mode	[1] Normal torque	All set-ups	FALSE	-	Uint8
1-06	Clockwise Direction	[0] Normal	All set-ups	FALSE	-	Uint8
1-1* Motor Selection						
1-10	Motor Construction	[0] Asynchron	All set-ups	FALSE	-	Uint8
1-1* VVC+ PM/SYN RM						
1-14	Damping Gain	ExpressionLimit	All set-ups	TRUE	0	Int16
1-15	Low Speed Filter Time Const.	ExpressionLimit	All set-ups	TRUE	-2	Uint16
1-16	High Speed Filter Time Const.	ExpressionLimit	All set-ups	TRUE	-2	Uint16
1-17	Voltage filter time const.	ExpressionLimit	All set-ups	TRUE	-3	Uint16
1-2* Motor Data						
1-20	Motor Power [kW]	ExpressionLimit	All set-ups	FALSE	1	Uint32
1-21	Motor Power [HP]	ExpressionLimit	All set-ups	FALSE	-2	Uint32
1-22	Motor Voltage	ExpressionLimit	All set-ups	FALSE	0	Uint16
1-23	Motor Frequency	ExpressionLimit	All set-ups	FALSE	0	Uint16
1-24	Motor Current	ExpressionLimit	All set-ups	FALSE	-2	Uint32
1-25	Motor Nominal Speed	ExpressionLimit	All set-ups	FALSE	67	Uint16
1-26	Motor Cont. Rated Torque	ExpressionLimit	All set-ups	FALSE	-1	Uint32
1-28	Motor Rotation Check	[0] Off	All set-ups	FALSE	-	Uint8
1-29	Automatic Motor Adaptation (AMA)	[0] Off	All set-ups	FALSE	-	Uint8
1-3* Adv. Motor Data						
1-30	Stator Resistance (Rs)	ExpressionLimit	All set-ups	FALSE	-4	Uint32
1-31	Rotor Resistance (Rr)	ExpressionLimit	All set-ups	FALSE	-4	Uint32
1-33	Stator Leakage Reactance (X1)	ExpressionLimit	All set-ups	FALSE	-4	Uint32
1-34	Rotor Leakage Reactance (X2)	ExpressionLimit	All set-ups	FALSE	-4	Uint32
1-35	Main Reactance (Xh)	ExpressionLimit	All set-ups	FALSE	-4	Uint32
1-36	Iron Loss Resistance (Rfe)	ExpressionLimit	All set-ups	FALSE	-3	Uint32
1-37	d-axis Inductance (Ld)	ExpressionLimit	All set-ups	FALSE	-6	Int32
1-38	q-axis Inductance (Lq)	ExpressionLimit	All set-ups	FALSE	-6	Int32
1-39	Motor Poles	ExpressionLimit	All set-ups	FALSE	0	Uint8
1-40	Back EMF at 1000 RPM	ExpressionLimit	All set-ups	FALSE	0	Uint16
1-44	d-axis Inductance Sat. (LdSat)	ExpressionLimit	All set-ups	FALSE	-6	Int32
1-45	q-axis Inductance Sat. (LqSat)	ExpressionLimit	All set-ups	FALSE	-6	Int32
1-46	Position Detection Gain	100%	All set-ups	TRUE	0	Uint16
1-47	Torque Calibration	[0] Off	All set-ups	TRUE	-	Uint8
1-48	Inductance Sat. Point	ExpressionLimit	All set-ups	FALSE	0	Int16
1-5* Load Indep. Setting						
1-50	Motor magnetization at Zero Speed	100%	All set-ups	TRUE	0	Uint16
1-51	Min Speed Normal Magnetizing [RPM]	ExpressionLimit	All set-ups	TRUE	67	Uint16
1-52	Min Speed Normal Magnetizing [Hz]	ExpressionLimit	All set-ups	TRUE	-1	Uint16
1-55	V/f Characteristic - V	ExpressionLimit	All set-ups	TRUE	-1	Uint16
1-56	V/f Characteristic - f	ExpressionLimit	All set-ups	TRUE	-1	Uint16

Parameter #	Parameter description	Default value	4 set-up	Change during operation	Conversion index	Type
1-58	Flying Start Test Pulses Current	ExpressionLimit	All set-ups	FALSE	0	Uint16
1-59	Flying Start Test Pulses Frequency	ExpressionLimit	All set-ups	FALSE	0	Uint16
1-6* Load Depen. Setting						
1-60	Low Speed Load Compensation	100%	All set-ups	TRUE	0	Int16
1-61	High Speed Load Compensation	100%	All set-ups	TRUE	0	Int16
1-62	Slip Compensation	0%	All set-ups	TRUE	0	Int16
1-63	Slip Compensation Time Constant	ExpressionLimit	All set-ups	TRUE	-2	Uint16
1-64	Resonance Damping	100%	All set-ups	TRUE	0	Uint16
1-65	Resonance Damping Time Constant	5 ms	All set-ups	TRUE	-3	Uint8
1-66	Min. Current at Low Speed	ExpressionLimit	All set-ups	TRUE	0	Uint8
1-7* Start Adjustments						
1-70	PM Start Mode	ExpressionLimit	All set-ups	TRUE	-	Uint8
1-71	Start Delay	00 s	All set-ups	TRUE	-1	Uint16
1-72	Start Function	ExpressionLimit	All set-ups	TRUE	-	Uint8
1-73	Flying Start	ExpressionLimit	All set-ups	FALSE	-	Uint8
1-77	Compressor Start Max Speed [RPM]	ExpressionLimit	All set-ups	TRUE	67	Uint16
1-78	Compressor Start Max Speed [Hz]	ExpressionLimit	All set-ups	TRUE	-1	Uint16
1-79	Pump Start Max Time to Trip	0 s	All set-ups	TRUE	-1	Uint16
1-8* Stop Adjustments						
1-80	Function at Stop	[0] Coast	All set-ups	TRUE	-	Uint8
1-81	Min Speed for Function at Stop [RPM]	ExpressionLimit	All set-ups	TRUE	67	Uint16
1-82	Min Speed for Function at Stop [Hz]	ExpressionLimit	All set-ups	TRUE	-1	Uint16
1-86	Trip Speed Low [RPM]	ExpressionLimit	All set-ups	TRUE	67	Uint16
1-87	Trip Speed Low [Hz]	ExpressionLimit	All set-ups	TRUE	-1	Uint16
1-9* Motor Temperature						
1-90	Motor Thermal Protection	ExpressionLimit	All set-ups	TRUE	-	Uint8
1-91	Motor External Fan	[0] No	All set-ups	TRUE	-	Uint8
1-93	Thermistor Source	[0] None	All set-ups	TRUE	-	Uint8
1-94	ATEX ETR cur.lim. speed reduction	0%	2 set-ups	TRUE	-1	Uint16
1-98	ATEX ETR interpol. points freq.	ExpressionLimit	1 set-up	TRUE	-1	Uint16
1-99	ATEX ETR interpol points current	ExpressionLimit	2 set-ups	TRUE	0	Uint16

4.1.4 2-** Brakes

Parameter #	Parameter description	Default value	4 set-up	Change during operation	Conversion index	Type
2-0* DC-Brake						
2-00	DC Hold/Preheat Current	50%	All set-ups	TRUE	0	Uint8
2-01	DC Brake Current	50%	All set-ups	TRUE	0	Uint16
2-02	DC Braking Time	10 s	All set-ups	TRUE	-1	Uint16
2-03	DC Brake Cut In Speed [RPM]	ExpressionLimit	All set-ups	TRUE	67	Uint16
2-04	DC Brake Cut In Speed [Hz]	ExpressionLimit	All set-ups	TRUE	-1	Uint16
2-06	Parking Current	50%	All set-ups	TRUE	0	Uint16
2-07	Parking Time	3 s	All set-ups	TRUE	-1	Uint16
2-1* Brake Energy Funct.						
2-10	Brake Function	ExpressionLimit	All set-ups	TRUE	-	Uint8
2-11	Brake Resistor (ohm)	ExpressionLimit	All set-ups	TRUE	0	Uint16
2-12	Brake Power Limit (kW)	ExpressionLimit	All set-ups	TRUE	0	Uint32
2-13	Brake Power Monitoring	[0] Off	All set-ups	TRUE	-	Uint8
2-15	Brake Check	[0] Off	All set-ups	TRUE	-	Uint8
2-16	AC brake Max. Current	100%	All set-ups	TRUE	-1	Uint32
2-17	Over-voltage Control	[2] Enabled	All set-ups	TRUE	-	Uint8

4.1.5 3-** Reference/Ramps

Parameter #	Parameter description	Default value	4 set-up	Change during operation	Conversion index	Type
3-0* Reference Limits						
3-02	Minimum Reference	ExpressionLimit	All set-ups	TRUE	-3	Int32
3-03	Maximum Reference	ExpressionLimit	All set-ups	TRUE	-3	Int32
3-04	Reference Function	[0] Sum	All set-ups	TRUE	-	Uint8
3-1* References						
3-10	Preset Reference	0%	All set-ups	TRUE	-2	Int16
3-11	Jog Speed [Hz]	ExpressionLimit	All set-ups	TRUE	-1	Uint16
3-13	Reference Site	[0] Linked to Hand/ Auto	All set-ups	TRUE	-	Uint8
3-14	Preset Relative Reference	0%	All set-ups	TRUE	-2	Int32
3-15	Reference 1 Source	[1] Analog Input 53	All set-ups	TRUE	-	Uint8
3-16	Reference 2 Source	[0] No function	All set-ups	TRUE	-	Uint8
3-17	Reference 3 Source	[0] No function	All set-ups	TRUE	-	Uint8
3-19	Jog Speed [RPM]	ExpressionLimit	All set-ups	TRUE	67	Uint16
3-4* Ramp 1						
3-41	Ramp 1 Ramp Up Time	ExpressionLimit	All set-ups	TRUE	-2	Uint32
3-42	Ramp 1 Ramp Down Time	ExpressionLimit	All set-ups	TRUE	-2	Uint32
3-5* Ramp 2						
3-51	Ramp 2 Ramp Up Time	ExpressionLimit	All set-ups	TRUE	-2	Uint32
3-52	Ramp 2 Ramp Down Time	ExpressionLimit	All set-ups	TRUE	-2	Uint32
3-8* Other Ramps						
3-80	Jog Ramp Time	ExpressionLimit	All set-ups	TRUE	-2	Uint32
3-81	Quick Stop Ramp Time	ExpressionLimit	2 set-ups	TRUE	-2	Uint32
3-84	Initial Ramp Time	0 s	All set-ups	TRUE	-2	Uint16
3-85	Check Valve Ramp Time	0 s	All set-ups	TRUE	-2	Uint16
3-86	Check Valve Ramp End Speed [RPM]	ExpressionLimit	All set-ups	TRUE	67	Uint16
3-87	Check Valve Ramp End Speed [HZ]	ExpressionLimit	All set-ups	TRUE	-1	Uint16
3-88	Final Ramp Time	0 s	All set-ups	TRUE	-2	Uint16
3-9* Digital Pot.Meter						
3-90	Step Size	0.10%	All set-ups	TRUE	-2	Uint16
3-91	Ramp Time	1 s	All set-ups	TRUE	-2	Uint32
3-92	Power Restore	[0] Off	All set-ups	TRUE	-	Uint8
3-93	Maximum Limit	100%	All set-ups	TRUE	0	Int16
3-94	Minimum Limit	0%	All set-ups	TRUE	0	Int16
3-95	Ramp Delay	ExpressionLimit	All set-ups	TRUE	-3	TimD

4.1.6 4-** Limits/Warnings

Parameter #	Parameter description	Default value	4 set-up	Change during operation	Conversion index	Type
4-1* Motor Limits						
4-10	Motor Speed Direction	[0] Clockwise	All set-ups	FALSE	-	Uint8
4-11	Motor Speed Low Limit [RPM]	ExpressionLimit	All set-ups	TRUE	67	Uint16
4-12	Motor Speed Low Limit [Hz]	ExpressionLimit	All set-ups	TRUE	-1	Uint16
4-13	Motor Speed High Limit [RPM]	ExpressionLimit	All set-ups	TRUE	67	Uint16
4-14	Motor Speed High Limit [Hz]	ExpressionLimit	All set-ups	TRUE	-1	Uint16
4-16	Torque Limit Motor Mode	ExpressionLimit	All set-ups	TRUE	-1	Uint16
4-17	Torque Limit Generator Mode	100%	All set-ups	TRUE	-1	Uint16
4-18	Current Limit	ExpressionLimit	All set-ups	TRUE	-1	Uint32
4-19	Max Output Frequency	ExpressionLimit	All set-ups	FALSE	-1	Uint16
4-5* Adj. Warnings						
4-50	Warning Current Low	0 A	All set-ups	TRUE	-2	Uint32
4-51	Warning Current High	ImaxVLT (P1637)	All set-ups	TRUE	-2	Uint32
4-52	Warning Speed Low	0 RPM	All set-ups	TRUE	67	Uint16
4-53	Warning Speed High	outputSpeed-HighLimit (P413)	All set-ups	TRUE	67	Uint16
4-54	Warning Reference Low	-999999.999 N/A	All set-ups	TRUE	-3	Int32
4-55	Warning Reference High	999999.999 N/A	All set-ups	TRUE	-3	Int32
4-56	Warning Feedback Low	-999999.999 ReferenceFeed-backUnit	All set-ups	TRUE	-3	Int32
4-57	Warning Feedback High	999999.999 ReferenceFeed-backUnit	All set-ups	TRUE	-3	Int32
4-58	Missing Motor Phase Function	[2] Trip 1000 ms	All set-ups	TRUE	-	Uint8
4-6* Speed Bypass						
4-60	Bypass Speed From [RPM]	ExpressionLimit	All set-ups	TRUE	67	Uint16
4-61	Bypass Speed From [Hz]	ExpressionLimit	All set-ups	TRUE	-1	Uint16
4-62	Bypass Speed To [RPM]	ExpressionLimit	All set-ups	TRUE	67	Uint16
4-63	Bypass Speed To [Hz]	ExpressionLimit	All set-ups	TRUE	-1	Uint16
4-64	Semi-Auto Bypass Set-up	[0] Off	All set-ups	FALSE	-	Uint8

4.1.7 5-** Digital In/Out

Parameter #	Parameter description	Default value	4 set-up	Change during operation	Conversion index	Type
5-0* Digital I/O mode						
5-00	Digital I/O Mode	[0] PNP - Active at 24 V	All set-ups	FALSE	-	Uint8
5-01	Terminal 27 Mode	[0] Input	All set-ups	TRUE	-	Uint8
5-02	Terminal 29 Mode	[0] Input	All set-ups	TRUE	-	Uint8
5-1* Digital Inputs						
5-10	Terminal 18 Digital Input	ExpressionLimit	All set-ups	TRUE	-	Uint8
5-11	Terminal 19 Digital Input	ExpressionLimit	All set-ups	TRUE	-	Uint8
5-12	Terminal 27 Digital Input	ExpressionLimit	All set-ups	TRUE	-	Uint8
5-13	Terminal 29 Digital Input	ExpressionLimit	All set-ups	TRUE	-	Uint8
5-14	Terminal 32 Digital Input	ExpressionLimit	All set-ups	TRUE	-	Uint8
5-15	Terminal 33 Digital Input	ExpressionLimit	All set-ups	TRUE	-	Uint8
5-16	Terminal X30/2 Digital Input	ExpressionLimit	All set-ups	TRUE	-	Uint8
5-17	Terminal X30/3 Digital Input	ExpressionLimit	All set-ups	TRUE	-	Uint8
5-18	Terminal X30/4 Digital Input	ExpressionLimit	All set-ups	TRUE	-	Uint8
5-19	Terminal 37 Digital Input	[1] Safe Stop Alarm	1 set-up	TRUE	-	Uint8
5-20	Terminal X46/1 Digital Input	ExpressionLimit	All set-ups	TRUE	-	Uint8
5-21	Terminal X46/3 Digital Input	ExpressionLimit	All set-ups	TRUE	-	Uint8
5-22	Terminal X46/5 Digital Input	ExpressionLimit	All set-ups	TRUE	-	Uint8
5-23	Terminal X46/7 Digital Input	ExpressionLimit	All set-ups	TRUE	-	Uint8
5-24	Terminal X46/9 Digital Input	ExpressionLimit	All set-ups	TRUE	-	Uint8
5-25	Terminal X46/11 Digital Input	ExpressionLimit	All set-ups	TRUE	-	Uint8
5-26	Terminal X46/13 Digital Input	ExpressionLimit	All set-ups	TRUE	-	Uint8
5-3* Digital Outputs						
5-30	Terminal 27 Digital Output	[0] No operation	All set-ups	TRUE	-	Uint8
5-31	Terminal 29 Digital Output	[0] No operation	All set-ups	TRUE	-	Uint8
5-32	Term X30/6 Digi Out (MCB 101)	[0] No operation	All set-ups	TRUE	-	Uint8
5-33	Term X30/7 Digi Out (MCB 101)	[0] No operation	All set-ups	TRUE	-	Uint8
5-4* Relays						
5-40	Function Relay	ExpressionLimit	All set-ups	TRUE	-	Uint8
5-41	On Delay, Relay	0.01 s	All set-ups	TRUE	-2	Uint16
5-42	Off Delay, Relay	0.01 s	All set-ups	TRUE	-2	Uint16
5-5* Pulse Input						
5-50	Term. 29 Low Frequency	100 Hz	All set-ups	TRUE	0	Uint32
5-51	Term. 29 High Frequency	100 Hz	All set-ups	TRUE	0	Uint32
5-52	Term. 29 Low Ref./Feedb. Value	0 N/A	All set-ups	TRUE	-3	Int32
5-53	Term. 29 High Ref./Feedb. Value	100 N/A	All set-ups	TRUE	-3	Int32
5-54	Pulse Filter Time Constant #29	100 ms	All set-ups	FALSE	-3	Uint16
5-55	Term. 33 Low Frequency	100 Hz	All set-ups	TRUE	0	Uint32
5-56	Term. 33 High Frequency	100 Hz	All set-ups	TRUE	0	Uint32
5-57	Term. 33 Low Ref./Feedb. Value	0 N/A	All set-ups	TRUE	-3	Int32
5-58	Term. 33 High Ref./Feedb. Value	100 N/A	All set-ups	TRUE	-3	Int32
5-59	Pulse Filter Time Constant #33	100 ms	All set-ups	FALSE	-3	Uint16
5-6* Pulse Output						
5-60	Terminal 27 Pulse Output Variable	[0] No operation	All set-ups	TRUE	-	Uint8
5-62	Pulse Output Max Freq #27	5000 Hz	All set-ups	TRUE	0	Uint32
5-63	Terminal 29 Pulse Output Variable	[0] No operation	All set-ups	TRUE	-	Uint8

Parameter #	Parameter description	Default value	4 set-up	Change during operation	Conversion index	Type
5-65	Pulse Output Max Freq #29	5000 Hz	All set-ups	TRUE	0	Uint32
5-66	Terminal X30/6 Pulse Output Variable	[0] No operation	All set-ups	TRUE	-	Uint8
5-68	Pulse Output Max Freq #X30/6	5000 Hz	All set-ups	TRUE	0	Uint32
5-8* I/O Options						
5-80	AHF Cap Reconnect Delay	25 s	2 set-ups	TRUE	0	Uint16
5-9* Bus Controlled						
5-90	Digital & Relay Bus Control	0 N/A	All set-ups	TRUE	0	Uint32
5-93	Pulse Out #27 Bus Control	0%	All set-ups	TRUE	-2	N2
5-94	Pulse Out #27 Timeout Preset	0%	1 set-up	TRUE	-2	Uint16
5-95	Pulse Out #29 Bus Control	0%	All set-ups	TRUE	-2	N2
5-96	Pulse Out #29 Timeout Preset	0%	1 set-up	TRUE	-2	Uint16
5-97	Pulse Out #X30/6 Bus Control	0%	All set-ups	TRUE	-2	N2
5-98	Pulse Out #X30/6 Timeout Preset	0%	1 set-up	TRUE	-2	Uint16

4.1.8 6-** Analog In/Out

Parameter #	Parameter description	Default value	4 set-up	Change during operation	Conversion index	Type
6-0* Analog I/O Mode						
6-00	Live Zero Timeout Time	10 s	All set-ups	TRUE	0	Uint8
6-01	Live Zero Timeout Function	[0] Off	All set-ups	TRUE	-	Uint8
6-1* Analog Input 53						
6-10	Terminal 53 Low Voltage	0.07 V	All set-ups	TRUE	-2	Int16
6-11	Terminal 53 High Voltage	10 V	All set-ups	TRUE	-2	Int16
6-12	Terminal 53 Low Current	4 mA	All set-ups	TRUE	-5	Int16
6-13	Terminal 53 High Current	20 mA	All set-ups	TRUE	-5	Int16
6-14	Terminal 53 Low Ref./Feedb. Value	0 N/A	All set-ups	TRUE	-3	Int32
6-15	Terminal 53 High Ref./Feedb. Value	ExpressionLimit	All set-ups	TRUE	-3	Int32
6-16	Terminal 53 Filter Time Constant	0.001 s	All set-ups	TRUE	-3	Uint16
6-17	Terminal 53 Live Zero	[1] Enabled	All set-ups	TRUE	-	Uint8
6-2* Analog Input 54						
6-20	Terminal 54 Low Voltage	0.07 V	All set-ups	TRUE	-2	Int16
6-21	Terminal 54 High Voltage	10 V	All set-ups	TRUE	-2	Int16
6-22	Terminal 54 Low Current	4 mA	All set-ups	TRUE	-5	Int16
6-23	Terminal 54 High Current	20 mA	All set-ups	TRUE	-5	Int16
6-24	Terminal 54 Low Ref./Feedb. Value	0 N/A	All set-ups	TRUE	-3	Int32
6-25	Terminal 54 High Ref./Feedb. Value	100 N/A	All set-ups	TRUE	-3	Int32
6-26	Terminal 54 Filter Time Constant	0.001 s	All set-ups	TRUE	-3	Uint16
6-27	Terminal 54 Live Zero	[1] Enabled	All set-ups	TRUE	-	Uint8
6-3* Analog Input X30/11						
6-30	Terminal X30/11 Low Voltage	0.07 V	All set-ups	TRUE	-2	Int16
6-31	Terminal X30/11 High Voltage	10 V	All set-ups	TRUE	-2	Int16
6-34	Term. X30/11 Low Ref./Feedb. Value	0 N/A	All set-ups	TRUE	-3	Int32
6-35	Term. X30/11 High Ref./Feedb. Value	100 N/A	All set-ups	TRUE	-3	Int32
6-36	Term. X30/11 Filter Time Constant	0.001 s	All set-ups	TRUE	-3	Uint16
6-37	Term. X30/11 Live Zero	[1] Enabled	All set-ups	TRUE	-	Uint8
6-4* Analog Input X30/12						
6-40	Terminal X30/12 Low Voltage	0.07 V	All set-ups	TRUE	-2	Int16
6-41	Terminal X30/12 High Voltage	10 V	All set-ups	TRUE	-2	Int16
6-44	Term. X30/12 Low Ref./Feedb. Value	0 N/A	All set-ups	TRUE	-3	Int32
6-45	Term. X30/12 High Ref./Feedb. Value	100 N/A	All set-ups	TRUE	-3	Int32
6-46	Term. X30/12 Filter Time Constant	0.001 s	All set-ups	TRUE	-3	Uint16
6-47	Term. X30/12 Live Zero	[1] Enabled	All set-ups	TRUE	-	Uint8
6-5* Analog Output 42						
6-50	Terminal 42 Output	[100] Output freq. 0-100	All set-ups	TRUE	-	Uint8
6-51	Terminal 42 Output Min Scale	0%	All set-ups	TRUE	-2	Int16
6-52	Terminal 42 Output Max Scale	100%	All set-ups	TRUE	-2	Int16
6-53	Terminal 42 Output Bus Control	0%	All set-ups	TRUE	-2	N2
6-54	Terminal 42 Output Timeout Preset	0%	1 set-up	TRUE	-2	Uint16
6-55	Terminal 42 Output Filter	[0] Off	1 set-up	TRUE	-	Uint8
6-6* Analog Output X30/8						
6-60	Terminal X30/8 Output	[0] No operation	All set-ups	TRUE	-	Uint8
6-61	Terminal X30/8 Min. Scale	0%	All set-ups	TRUE	-2	Int16
6-62	Terminal X30/8 Max. Scale	100%	All set-ups	TRUE	-2	Int16

Parameter #	Parameter description	Default value	4 set-up	Change during operation	Conversion index	Type
6-63	Terminal X30/8 Output Bus Control	0%	All set-ups	TRUE	-2	N2
6-64	Terminal X30/8 Output Timeout Preset	0%	1 set-up	TRUE	-2	Uint16
6-7* Analog Output X45/1						
6-70	Terminal X45/1 Output	[0] No operation	All set-ups	TRUE	-	Uint8
6-71	Terminal X45/1 Min. Scale	0%	All set-ups	TRUE	-2	Int16
6-72	Terminal X45/1 Max. Scale	100%	All set-ups	TRUE	-2	Int16
6-73	Terminal X45/1 Bus Control	0%	All set-ups	TRUE	-2	N2
6-74	Terminal X45/1 Output Timeout Preset	0%	1 set-up	TRUE	-2	Uint16
6-8* Analog Output X45/3						
6-80	Terminal X45/3 Output	[0] No operation	All set-ups	TRUE	-	Uint8
6-81	Terminal X45/3 Min. Scale	0%	All set-ups	TRUE	-2	Int16
6-82	Terminal X45/3 Max. Scale	100%	All set-ups	TRUE	-2	Int16
6-83	Terminal X45/3 Bus Control	0%	All set-ups	TRUE	-2	N2
6-84	Terminal X45/3 Output Timeout Preset	0%	1 set-up	TRUE	-2	Uint16

4.1.9 8-** Comm. and Options

Parameter #	Parameter description	Default value	4 set-up	Change during operation	Conversion index	Type
8-0* General Settings						
8-01	Control Site	[0] Digital and ctrl.word	All set-ups	TRUE	-	Uint8
8-02	Control Source	ExpressionLimit	All set-ups	TRUE	-	Uint8
8-03	Control Timeout Time	ExpressionLimit	1 set-up	TRUE	-1	Uint32
8-04	Control Timeout Function	[0] Off	1 set-up	TRUE	-	Uint8
8-05	End-of-Timeout Function	[1] Resume set-up	1 set-up	TRUE	-	Uint8
8-06	Reset Control Timeout	[0] Do not reset	All set-ups	TRUE	-	Uint8
8-07	Diagnosis Trigger	[0] Disable	2 set-ups	TRUE	-	Uint8
8-08	Readout Filtering	ExpressionLimit	All set-ups	TRUE	-	Uint8
8-1* Control Settings						
8-10	Control Profile	[0] FC profile	All set-ups	TRUE	-	Uint8
8-13	Configurable Status Word STW	[1] Profile Default	All set-ups	TRUE	-	Uint8
8-14	Configurable Control Word CTW	[1] Profile default	2 set-ups	TRUE	-	Uint8
8-17	Configurable Alarm and Warningword	[0] Off	All set-ups	TRUE	-	Uint16
8-3* FC Port Settings						
8-30	Protocol	[0] FC	1 set-up	TRUE	-	Uint8
8-31	Address	ExpressionLimit	1 set-up	TRUE	0	Uint8
8-32	Baud Rate	ExpressionLimit	1 set-up	TRUE	-	Uint8
8-33	Parity/Stop Bits	ExpressionLimit	1 set-up	TRUE	-	Uint8
8-35	Minimum Response Delay	10 ms	1 set-up	TRUE	-3	Uint16
8-36	Max Response Delay	ExpressionLimit	1 set-up	TRUE	-3	Uint16
8-37	Maximum Inter-Char Delay	ExpressionLimit	1 set-up	TRUE	-5	Uint16
8-4* FC MC protocol set						
8-40	Telegram Selection	[1] Standard telegram 1	2 set-ups	TRUE	-	Uint8
8-42	PCD Write Configuration	ExpressionLimit	2 set-ups	TRUE	-	Uint16
8-43	PCD Read Configuration	ExpressionLimit	2 set-ups	TRUE	-	Uint16
8-5* Digital/Bus						
8-50	Coasting Select	[3] Logic OR	All set-ups	TRUE	-	Uint8
8-51	Quick Stop Select	[4] Disabled	All set-ups	TRUE	-	Uint8
8-52	DC Brake Select	ExpressionLimit	All set-ups	TRUE	-	Uint8
8-53	Start Select	[3] Logic OR	All set-ups	TRUE	-	Uint8
8-54	Reversing Select	[0] Digital input	All set-ups	TRUE	-	Uint8
8-55	Set-up Select	[3] Logic OR	All set-ups	TRUE	-	Uint8
8-56	Preset Reference Select	[3] Logic OR	All set-ups	TRUE	-	Uint8
8-7* BACnet						
8-70	BACnet Device Instance	1 N/A	1 set-up	TRUE	0	Uint32
8-72	MS/TP Max Masters	127 N/A	1 set-up	TRUE	0	Uint8
8-73	MS/TP Max Info Frames	1 N/A	1 set-up	TRUE	0	Uint16
8-74	"I-Am" Service	[0] Send at power-up	1 set-up	TRUE	-	Uint8
8-75	Initialisation Password	ExpressionLimit	1 set-up	TRUE	0	VisStr[20]
8-8* FC Port Diagnostics						
8-80	Bus Message Count	0 N/A	All set-ups	TRUE	0	Uint32
8-81	Bus Error Count	0 N/A	All set-ups	TRUE	0	Uint32

Parameter #	Parameter description	Default value	4 set-up	Change during operation	Conversion index	Type
8-82	Slave Message Rcvd	0 N/A	All set-ups	TRUE	0	Uint32
8-83	Slave Error Count	0 N/A	All set-ups	TRUE	0	Uint32
8-9* Bus Jog/Feedback						
8-90	Bus Jog 1 Speed	100 RPM	All set-ups	TRUE	67	Uint16
8-91	Bus Jog 2 Speed	ExpressionLimit	All set-ups	TRUE	67	Uint16
8-94	Bus Feedback 1	0 N/A	1 set-up	TRUE	0	N2
8-95	Bus Feedback 2	0 N/A	1 set-up	TRUE	0	N2
8-96	Bus Feedback 3	0 N/A	1 set-up	TRUE	0	N2

4.1.10 9-** PROFIdrive

Parameter #	Parameter description	Default value	4 set-up	Change during operation	Conversion index	Type
9-00	Setpoint	0 N/A	All set-ups	TRUE	0	Uint16
9-07	Actual Value	0 N/A	All set-ups	FALSE	0	Uint16
9-15	PCD Write Configuration	ExpressionLimit	1 set-up	TRUE	-	Uint16
9-16	PCD Read Configuration	ExpressionLimit	2 set-ups	TRUE	-	Uint16
9-18	Node Address	126 N/A	1 set-up	TRUE	0	Uint8
9-22	Telegram Selection	[100] None	1 set-up	TRUE	-	Uint8
9-23	Parameters for Signals	0	All set-ups	TRUE	-	Uint16
9-27	Parameter Edit	[1] Enabled	2 set-ups	FALSE	-	Uint16
9-28	Process Control	[1] Enable cyclic master	2 set-ups	FALSE	-	Uint8
9-31	Safe Address	0 N/A	1 set-up	TRUE	0	Uint16
9-44	Fault Message Counter	0 N/A	All set-ups	TRUE	0	Uint16
9-45	Fault Code	0 N/A	All set-ups	TRUE	0	Uint16
9-47	Fault Number	0 N/A	All set-ups	TRUE	0	Uint16
9-52	Fault Situation Counter	0 N/A	All set-ups	TRUE	0	Uint16
9-53	PROFIBUS Warning Word	0 N/A	All set-ups	TRUE	0	V2
9-63	Actual Baud Rate	[255] No baudrate found	All set-ups	TRUE	-	Uint8
9-64	Device Identification	0 N/A	All set-ups	TRUE	0	Uint16
9-65	Profile Number	0 N/A	All set-ups	TRUE	0	OctStr[2]
9-67	Control Word 1	0 N/A	All set-ups	FALSE	0	V2
9-68	Status Word 1	0 N/A	All set-ups	TRUE	0	V2
9-70	Programming Set-up	[9] Active Set-up	All set-ups	TRUE	-	Uint8
9-71	PROFIBUS Save Data Values	[0] Off	All set-ups	TRUE	-	Uint8
9-72	ProfibusDriveReset	[0] No action	1 set-up	FALSE	-	Uint8
9-75	DO Identification	0 N/A	All set-ups	TRUE	0	Uint16
9-80	Defined Parameters (1)	0 N/A	All set-ups	FALSE	0	Uint16
9-81	Defined Parameters (2)	0 N/A	All set-ups	FALSE	0	Uint16
9-82	Defined Parameters (3)	0 N/A	All set-ups	FALSE	0	Uint16
9-83	Defined Parameters (4)	0 N/A	All set-ups	FALSE	0	Uint16
9-84	Defined Parameters (5)	0 N/A	All set-ups	FALSE	0	Uint16
9-85	Defined Parameters (6)	0 N/A	All set-ups	FALSE	0	Uint16
9-90	Changed Parameters (1)	0 N/A	All set-ups	FALSE	0	Uint16
9-91	Changed Parameters (2)	0 N/A	All set-ups	FALSE	0	Uint16
9-92	Changed Parameters (3)	0 N/A	All set-ups	FALSE	0	Uint16
9-93	Changed Parameters (4)	0 N/A	All set-ups	FALSE	0	Uint16

Parameter #	Parameter description	Default value	4 set-up	Change during operation	Conversion index	Type
9-94	Changed Parameters (5)	0 N/A	All set-ups	FALSE	0	Uint16
9-99	PROFIBUS Revision Counter	0 N/A	All set-ups	TRUE	0	Uint16

4.1.11 10-** CAN Fieldbus

Parameter #	Parameter description	Default value	4 set-up	Change during operation	Conversion index	Type
10-0* Common Settings						
10-00	CAN Protocol	[1] DeviceNet	2 set-ups	FALSE	-	Uint8
10-01	Baud Rate Select	ExpressionLimit	2 set-ups	TRUE	-	Uint8
10-02	MAC ID	ExpressionLimit	2 set-ups	TRUE	0	Uint8
10-05	Readout Transmit Error Counter	0 N/A	All set-ups	TRUE	0	Uint8
10-06	Readout Receive Error Counter	0 N/A	All set-ups	TRUE	0	Uint8
10-07	Readout Bus Off Counter	0 N/A	All set-ups	TRUE	0	Uint8
10-1* DeviceNet						
10-10	Process Data Type Selection	ExpressionLimit	All set-ups	TRUE	-	Uint8
10-11	Process Data Config Write	ExpressionLimit	All set-ups	TRUE	-	Uint16
10-12	Process Data Config Read	ExpressionLimit	2 set-ups	TRUE	-	Uint16
10-13	Warning Parameter	0 N/A	All set-ups	TRUE	0	Uint16
10-14	Net Reference	[0] Off	2 set-ups	TRUE	-	Uint8
10-15	Net Control	[0] Off	2 set-ups	TRUE	-	Uint8
10-2* COS Filters						
10-20	COS Filter 1	0 N/A	All set-ups	FALSE	0	Uint16
10-21	COS Filter 2	0 N/A	All set-ups	FALSE	0	Uint16
10-22	COS Filter 3	0 N/A	All set-ups	FALSE	0	Uint16
10-23	COS Filter 4	0 N/A	All set-ups	FALSE	0	Uint16
10-3* Parameter Access						
10-30	Array Index	0 N/A	2 set-ups	TRUE	0	Uint8
10-31	Store Data Values	[0] Off	All set-ups	TRUE	-	Uint8
10-32	DeviceNet Revision	ExpressionLimit	All set-ups	TRUE	0	Uint16
10-33	Store Always	[0] Off	1 set-up	TRUE	-	Uint8
10-34	DeviceNet Product Code	ExpressionLimit	1 set-up	TRUE	0	Uint16
10-39	DeviceNet F Parameters	0 N/A	All set-ups	TRUE	0	Uint32

4.1.12 13-** Smart Logic

Parameter #	Parameter description	Default value	4 set-up	Change during operation	Conversion index	Type
13-0* SLC Settings						
13-00	SL Controller Mode	ExpressionLimit	2 set-ups	TRUE	-	Uint8
13-01	Start Event	ExpressionLimit	2 set-ups	TRUE	-	Uint8
13-02	Stop Event	ExpressionLimit	2 set-ups	TRUE	-	Uint8
13-03	Reset SLC	[0] Do not reset SLC	All set-ups	TRUE	-	Uint8
13-1* Comparators						
13-10	Comparator Operand	ExpressionLimit	2 set-ups	TRUE	-	Uint8
13-11	Comparator Operator	ExpressionLimit	2 set-ups	TRUE	-	Uint8
13-12	Comparator Value	ExpressionLimit	2 set-ups	TRUE	-3	Int32
13-1* RS Flip Flops						
13-15	RS-FF Operand S	ExpressionLimit	2 set-ups	TRUE	-	Uint8
13-16	RS-FF Operand R	ExpressionLimit	2 set-ups	TRUE	-	Uint8
13-2* Timers						
13-20	SL Controller Timer	ExpressionLimit	1 set-up	TRUE	-3	TimD
13-4* Logic Rules						
13-40	Logic Rule Boolean 1	ExpressionLimit	2 set-ups	TRUE	-	Uint8
13-41	Logic Rule Operator 1	ExpressionLimit	2 set-ups	TRUE	-	Uint8
13-42	Logic Rule Boolean 2	ExpressionLimit	2 set-ups	TRUE	-	Uint8
13-43	Logic Rule Operator 2	ExpressionLimit	2 set-ups	TRUE	-	Uint8
13-44	Logic Rule Boolean 3	ExpressionLimit	2 set-ups	TRUE	-	Uint8
13-5* States						
13-51	SL Controller Event	ExpressionLimit	2 set-ups	TRUE	-	Uint8
13-52	SL Controller Action	ExpressionLimit	2 set-ups	TRUE	-	Uint8
13-9* User Defined Alerts						
13-90	Alert Trigger	[0] False	2 set-ups	TRUE	-	Uint8
13-91	Alert Action	[0] Info	2 set-ups	TRUE	-	Uint8
13-92	Alert Text	ExpressionLimit	2 set-ups	TRUE	0	VisStr[20]
13-9* User Defined Readouts						
13-97	Alert Alarm Word	0 N/A	All set-ups	FALSE	0	Uint32
13-98	Alert Warning Word	0 N/A	All set-ups	FALSE	0	Uint32
13-99	Alert Status Word	0 N/A	All set-ups	FALSE	0	Uint32

4.1.13 14-** Special Functions

Parameter #	Parameter description	Default value	4 set-up	Change during operation	Conversion index	Type
14-0* Inverter Switching						
14-00	Switching Pattern	ExpressionLimit	All set-ups	TRUE	-	Uint8
14-01	Switching Frequency	ExpressionLimit	All set-ups	TRUE	-	Uint8
14-03	Overmodulation	[1] On	All set-ups	FALSE	-	Uint8
14-04	PWM Random	[0] Off	All set-ups	TRUE	-	Uint8
14-1* Mains On/Off						
14-10	Mains Failure	[0] No function	All set-ups	FALSE	-	Uint8
14-11	Mains Voltage at Mains Fault	ExpressionLimit	All set-ups	TRUE	0	Uint16
14-12	Function at Mains Imbalance	[3] Derate	All set-ups	TRUE	-	Uint8
14-16	Kin. Backup Gain	100%	All set-ups	TRUE	0	Uint32
14-2* Reset Functions						
14-20	Reset Mode	[10] Automatic reset x 10	All set-ups	TRUE	-	Uint8
14-21	Automatic Restart Time	10 s	All set-ups	TRUE	0	Uint16
14-22	Operation Mode	[0] Normal operation	All set-ups	TRUE	-	Uint8
14-23	Typecode Setting	ExpressionLimit	2 set-ups	FALSE	-	Uint16
14-25	Trip Delay at Torque Limit	60 s	All set-ups	TRUE	0	Uint8
14-26	Trip Delay at Inverter Fault	ExpressionLimit	All set-ups	TRUE	0	Uint8
14-28	Production Settings	[0] No action	All set-ups	TRUE	-	Uint8
14-29	Service Code	0 N/A	All set-ups	TRUE	0	Int32
14-3* Current Limit Ctrl.						
14-30	Current Lim Ctrl, Proportional Gain	100%	All set-ups	FALSE	0	Uint16
14-31	Current Lim Ctrl, Integration Time	ExpressionLimit	All set-ups	FALSE	-3	Uint16
14-32	Current Lim Ctrl, Filter Time	ExpressionLimit	All set-ups	FALSE	-4	Uint16
14-4* Energy Optimizing						
14-40	VT Level	66%	All set-ups	FALSE	0	Uint8
14-41	AEO Minimum Magnetization	ExpressionLimit	All set-ups	TRUE	0	Uint8
14-42	Minimum AEO Frequency	ExpressionLimit	All set-ups	TRUE	0	Uint8
14-43	Motor Cosphi	ExpressionLimit	All set-ups	TRUE	-2	Uint16
14-5* Environment						
14-50	RFI Filter	[1] On	1 set-up	FALSE	-	Uint8
14-51	DC Link Compensation	ExpressionLimit	All set-ups	TRUE	-	Uint8
14-52	Fan Control	[0] Auto	All set-ups	TRUE	-	Uint8
14-53	Fan Monitor	[1] Warning	All set-ups	TRUE	-	Uint8
14-55	Output Filter	[0] No Filter	1 set-up	FALSE	-	Uint8
14-56	Capacitance Output Filter	2 uF	1 set-up	FALSE	-7	Uint16
14-57	Inductance Output Filter	7 mH	1 set-up	FALSE	-6	Uint16
14-58	Voltage Gain Filter	100%	All set-ups	TRUE	0	Uint16
14-59	Actual Number of Inverter Units	ExpressionLimit	1 set-up	FALSE	0	Uint8
14-6* Auto Derate						
14-60	Function at Over Temperature	[1] Derate	All set-ups	TRUE	-	Uint8
14-61	Function at Inverter Overload	[1] Derate	All set-ups	TRUE	-	Uint8
14-62	Inv. Overload Derate Current	95%	All set-ups	TRUE	0	Uint16
14-8* Options						
14-80	Option Supplied by External 24VDC	[0] No	2 set-ups	FALSE	-	Uint8
14-9* Fault Settings						

Parameter #	Parameter description	Default value	4 set-up	Change during operation	Conversion index	Type
14-90	Fault Level	ExpressionLimit	1 set-up	TRUE	-	Uint8

4.1.14 15-** Drive Information

Parameter #	Parameter description	Default value	4 set-up	Change during operation	Conversion index	Type
15-0* Operating Data						
15-00	Operating hours	0 h	All set-ups	FALSE	74	Uint32
15-01	Running Hours	0 h	All set-ups	FALSE	74	Uint32
15-02	kWh Counter	0 kWh	All set-ups	FALSE	75	Uint32
15-03	Power Up's	0 N/A	All set-ups	FALSE	0	Uint32
15-04	Over Temp's	0 N/A	All set-ups	FALSE	0	Uint16
15-05	Over Volt's	0 N/A	All set-ups	FALSE	0	Uint16
15-06	Reset kWh Counter	[0] Do not reset	All set-ups	TRUE	-	Uint8
15-07	Reset Running Hours Counter	[0] Do not reset	All set-ups	TRUE	-	Uint8
15-08	Number of Starts	0 N/A	All set-ups	FALSE	0	Uint32
15-1* Data Log Settings						
15-10	Logging Source	0	2 set-ups	TRUE	-	Uint16
15-11	Logging Interval	ExpressionLimit	2 set-ups	TRUE	-3	TimD
15-12	Trigger Event	[0] False	1 set-up	TRUE	-	Uint8
15-13	Logging Mode	[0] Log always	2 set-ups	TRUE	-	Uint8
15-14	Samples Before Trigger	50 N/A	2 set-ups	TRUE	0	Uint8
15-2* Historic Log						
15-20	Historic Log: Event	0 N/A	All set-ups	FALSE	0	Uint8
15-21	Historic Log: Value	0 N/A	All set-ups	FALSE	0	Uint32
15-22	Historic Log: Time	0 ms	All set-ups	FALSE	-3	Uint32
15-23	Historic log: Date and Time	ExpressionLimit	All set-ups	FALSE	0	TimeOfDay
15-3* Alarm Log						
15-30	Alarm Log: Error Code	0 N/A	All set-ups	FALSE	0	Uint16
15-31	Alarm Log: Value	0 N/A	All set-ups	FALSE	0	Int16
15-32	Alarm Log: Time	0 s	All set-ups	FALSE	0	Uint32
15-33	Alarm Log: Date and Time	ExpressionLimit	All set-ups	FALSE	0	TimeOfDay
15-34	Alarm Log: Setpoint	0 ProcessCtrlUnit	All set-ups	FALSE	-3	Int32
15-35	Alarm Log: Feedback	0 ProcessCtrlUnit	All set-ups	FALSE	-3	Int32
15-36	Alarm Log: Current Demand	0%	All set-ups	FALSE	0	Uint8
15-37	Alarm Log: Process Ctrl Unit	[0]	All set-ups	FALSE	-	Uint8
15-4* Drive Identification						
15-40	FC Type	0 N/A	All set-ups	FALSE	0	VisStr[6]
15-41	Power Section	0 N/A	All set-ups	FALSE	0	VisStr[20]
15-42	Voltage	0 N/A	All set-ups	FALSE	0	VisStr[20]
15-43	Software Version	0 N/A	All set-ups	FALSE	0	VisStr[5]
15-44	Ordered Typecode String	0 N/A	All set-ups	FALSE	0	VisStr[40]
15-45	Actual Typecode String	0 N/A	All set-ups	FALSE	0	VisStr[40]
15-46	Frequency Converter Ordering No	0 N/A	All set-ups	FALSE	0	VisStr[8]
15-47	Power Card Ordering No	0 N/A	All set-ups	FALSE	0	VisStr[8]
15-48	LCP Id No	0 N/A	All set-ups	FALSE	0	VisStr[20]
15-49	SW ID Control Card	0 N/A	All set-ups	FALSE	0	VisStr[20]
15-50	SW ID Power Card	0 N/A	All set-ups	FALSE	0	VisStr[20]
15-51	Frequency Converter Serial Number	0 N/A	All set-ups	FALSE	0	VisStr[10]
15-53	Power Card Serial Number	0 N/A	All set-ups	FALSE	0	VisStr[19]
15-54	Config File Name	ExpressionLimit	All set-ups	FALSE	0	VisStr[16]
15-58	SmartStart Filename	ExpressionLimit	All set-ups	TRUE	0	VisStr[20]
15-59	Filename	ExpressionLimit	1 set-up	FALSE	0	VisStr[16]

Parameter #	Parameter description	Default value	4 set-up	Change during operation	Conversion index	Type
15-6* Option Ident						
15-60	Option Mounted	0 N/A	All set-ups	FALSE	0	VisStr[30]
15-61	Option SW Version	0 N/A	All set-ups	FALSE	0	VisStr[20]
15-62	Option Ordering No	0 N/A	All set-ups	FALSE	0	VisStr[8]
15-63	Option Serial No	0 N/A	All set-ups	FALSE	0	VisStr[18]
15-70	Option in Slot A	0 N/A	All set-ups	FALSE	0	VisStr[30]
15-71	Slot A Option SW Version	0 N/A	All set-ups	FALSE	0	VisStr[20]
15-72	Option in Slot B	0 N/A	All set-ups	FALSE	0	VisStr[30]
15-73	Slot B Option SW Version	0 N/A	All set-ups	FALSE	0	VisStr[20]
15-74	Option in Slot C0/E0	0 N/A	All set-ups	FALSE	0	VisStr[30]
15-75	Slot C0/E0 Option SW Version	0 N/A	All set-ups	FALSE	0	VisStr[20]
15-76	Option in Slot C1/E1	0 N/A	All set-ups	FALSE	0	VisStr[30]
15-77	Slot C1/E1 Option SW Version	0 N/A	All set-ups	FALSE	0	VisStr[20]
15-8* Operating Data II						
15-80	Fan Running Hours	0 h	All set-ups	TRUE	74	Uint32
15-81	Preset Fan Running Hours	0 h	All set-ups	TRUE	74	Uint32
15-9* Parameter Info						
15-92	Defined Parameters	0 N/A	All set-ups	FALSE	0	Uint16
15-93	Modified Parameters	0 N/A	All set-ups	FALSE	0	Uint16
15-98	Drive Identification	0 N/A	All set-ups	FALSE	0	VisStr[40]
15-99	Parameter Metadata	0 N/A	All set-ups	FALSE	0	Uint16

4.1.15 16-** Data Readouts

Parameter #	Parameter description	Default value	4 set-up	Change during operation	Conversion index	Type
16-0* General Status						
16-00	Control Word	0 N/A	All set-ups	TRUE	0	V2
16-01	Reference [Unit]	0 ReferenceFeed-backUnit	All set-ups	TRUE	-3	Int32
16-02	Reference [%]	0%	All set-ups	TRUE	-1	Int16
16-03	Status Word	0 N/A	All set-ups	TRUE	0	V2
16-05	Main Actual Value [%]	0%	All set-ups	TRUE	-2	N2
16-09	Custom Readout	0 CustomReadoutUnit	All set-ups	TRUE	-2	Int32
16-1* Motor Status						
16-10	Power [kW]	0 kW	All set-ups	TRUE	1	Int32
16-11	Power [hp]	0 hp	All set-ups	TRUE	-2	Int32
16-12	Motor Voltage	0 V	All set-ups	TRUE	-1	UInt16
16-13	Frequency	0 Hz	All set-ups	TRUE	-1	UInt16
16-14	Motor current	0 A	All set-ups	TRUE	-2	Int32
16-15	Frequency [%]	0%	All set-ups	TRUE	-2	N2
16-16	Torque [Nm]	0 Nm	All set-ups	TRUE	-1	Int32
16-17	Speed [RPM]	0 RPM	All set-ups	TRUE	67	Int32
16-18	Motor Thermal	0%	All set-ups	TRUE	0	UInt8
16-20	Motor Angle	0 N/A	All set-ups	TRUE	0	UInt16
16-22	Torque [%]	0%	All set-ups	TRUE	0	Int16
16-23	Motor Shaft Power [kW]	0 kW	All set-ups	TRUE	1	Int32
16-24	Calibrated Stator Resistance	0.0000 Ohm	All set-ups	TRUE	-4	UInt32
16-26	Power Filtered [kW]	0 kW	All set-ups	FALSE	0	Int32
16-27	Power Filtered [hp]	0 hp	All set-ups	FALSE	-3	Int32
16-3* Drive Status						
16-30	DC Link Voltage	0 V	All set-ups	TRUE	0	UInt16
16-31	System Temp.	0 °C	All set-ups	TRUE	100	Int8
16-32	Brake Energy /s	0 kW	All set-ups	TRUE	0	UInt32
16-33	Brake Energy Average	0 kW	All set-ups	TRUE	0	UInt32
16-34	Heatsink Temp.	0 °C	All set-ups	TRUE	100	UInt8
16-35	Inverter Thermal	0%	All set-ups	TRUE	0	UInt8
16-36	Inv. Nom. Current	ExpressionLimit	All set-ups	TRUE	-2	UInt32
16-37	Inv. Max. Current	ExpressionLimit	All set-ups	TRUE	-2	UInt32
16-38	SL Controller State	0 N/A	All set-ups	TRUE	0	UInt8
16-39	Control Card Temp.	0 °C	All set-ups	TRUE	100	UInt8
16-40	Logging Buffer Full	[0] No	All set-ups	TRUE	-	UInt8
16-49	Current Fault Source	0 N/A	All set-ups	TRUE	0	UInt8
16-5* Ref. & Feedb.						
16-50	External Reference	0 N/A	All set-ups	TRUE	-1	Int16
16-52	Feedback[Unit]	0 ProcessCtrlUnit	All set-ups	TRUE	-3	Int32
16-53	Digi Pot Reference	0 N/A	All set-ups	TRUE	-2	Int16
16-54	Feedback 1 [Unit]	0 ProcessCtrlUnit	All set-ups	TRUE	-3	Int32
16-55	Feedback 2 [Unit]	0 ProcessCtrlUnit	All set-ups	TRUE	-3	Int32
16-56	Feedback 3 [Unit]	0 ProcessCtrlUnit	All set-ups	TRUE	-3	Int32
16-58	PID Output [%]	0%	All set-ups	TRUE	-1	Int16
16-59	Adjusted Setpoint	0 ProcessCtrlUnit	All set-ups	TRUE	-3	Int32

Parameter #	Parameter description	Default value	4 set-up	Change during operation	Conversion index	Type
16-6* Inputs & Outputs						
16-60	Digital Input	0 N/A	All set-ups	TRUE	0	Uint16
16-61	Terminal 53 Switch Setting	[0] Current	All set-ups	TRUE	-	Uint8
16-62	Analog Input 53	0 N/A	All set-ups	TRUE	-3	Int32
16-63	Terminal 54 Switch Setting	[0] Current	All set-ups	TRUE	-	Uint8
16-64	Analog Input 54	0 N/A	All set-ups	TRUE	-3	Int32
16-65	Analog Output 42 [mA]	0 N/A	All set-ups	TRUE	-3	Int16
16-66	Digital Output [bin]	0 N/A	All set-ups	TRUE	0	Int16
16-67	Pulse Input #29 [Hz]	0 N/A	All set-ups	TRUE	0	Int32
16-68	Pulse Input #33 [Hz]	0 N/A	All set-ups	TRUE	0	Int32
16-69	Pulse Output #27 [Hz]	0 N/A	All set-ups	TRUE	0	Int32
16-70	Pulse Output #29 [Hz]	0 N/A	All set-ups	TRUE	0	Int32
16-71	Relay Output [bin]	0 N/A	All set-ups	TRUE	0	Uint16
16-72	Counter A	0 N/A	All set-ups	TRUE	0	Int32
16-73	Counter B	0 N/A	All set-ups	TRUE	0	Int32
16-75	Analog In X30/11	0 N/A	All set-ups	TRUE	-3	Int32
16-76	Analog In X30/12	0 N/A	All set-ups	TRUE	-3	Int32
16-77	Analog Out X30/8 [mA]	0 N/A	All set-ups	TRUE	-3	Int16
16-78	Analog Out X45/1 [mA]	0 N/A	All set-ups	FALSE	-3	Int16
16-79	Analog Out X45/3 [mA]	0 N/A	All set-ups	FALSE	-3	Int16
16-8* Fieldbus & FC Port						
16-80	Fieldbus CTW 1	0 N/A	All set-ups	TRUE	0	V2
16-82	Fieldbus REF 1	0 N/A	All set-ups	TRUE	0	N2
16-84	Comm. Option STW	0 N/A	All set-ups	TRUE	0	V2
16-85	FC Port CTW 1	0 N/A	All set-ups	FALSE	0	V2
16-86	FC Port REF 1	0 N/A	All set-ups	FALSE	0	N2
16-89	Configurable Alarm/Warning Word	0 N/A	All set-ups	FALSE	0	Uint16
16-9* Diagnosis Readouts						
16-90	Alarm Word	0 N/A	All set-ups	TRUE	0	Uint32
16-91	Alarm Word 2	0 N/A	All set-ups	TRUE	0	Uint32
16-92	Warning Word	0 N/A	All set-ups	TRUE	0	Uint32
16-93	Warning Word 2	0 N/A	All set-ups	TRUE	0	Uint32
16-94	Ext. Status Word	0 N/A	All set-ups	TRUE	0	Uint32
16-95	Ext. Status Word 2	0 N/A	All set-ups	TRUE	0	Uint32
16-96	Maintenance Word	0 N/A	All set-ups	TRUE	0	Uint32

4.1.16 18-** Info & Readouts

Parameter #	Parameter description	Default value	4 set-up	Change during operation	Conversion index	Type
18-0* Maintenance Log						
18-00	Maintenance Log: Item	0 N/A	All set-ups	FALSE	0	UInt8
18-01	Maintenance Log: Action	0 N/A	All set-ups	FALSE	0	UInt8
18-02	Maintenance Log: Time	0 s	All set-ups	FALSE	0	UInt32
18-03	Maintenance Log: Date and Time	ExpressionLimit	All set-ups	FALSE	0	TimeOfDay
18-3* Analog Readouts						
18-30	Analog Input X42/1	0 N/A	All set-ups	FALSE	-3	Int32
18-31	Analog Input X42/3	0 N/A	All set-ups	FALSE	-3	Int32
18-32	Analog Input X42/5	0 N/A	All set-ups	FALSE	-3	Int32
18-33	Analog Out X42/7 [V]	0 N/A	All set-ups	FALSE	-3	Int16
18-34	Analog Out X42/9 [V]	0 N/A	All set-ups	FALSE	-3	Int16
18-35	Analog Out X42/11 [V]	0 N/A	All set-ups	FALSE	-3	Int16
18-36	Analog Input X48/2 [mA]	0 N/A	All set-ups	TRUE	-3	Int32
18-37	Temp. Input X48/4	0 N/A	All set-ups	TRUE	0	Int16
18-38	Temp. Input X48/7	0 N/A	All set-ups	TRUE	0	Int16
18-39	Temp. Input X48/10	0 N/A	All set-ups	TRUE	0	Int16
18-5* Ref. & Feedb.						
18-50	Sensorless Readout [unit]	0 SensorlessUnit	All set-ups	FALSE	-3	Int32
18-6* Inputs & Outputs 2						
18-60	Digital Input 2	0 N/A	All set-ups	TRUE	0	UInt16
18-7* Rectifier Status						
18-70	Mains Voltage	0 V	All set-ups	TRUE	0	UInt16
18-71	Mains Frequency	0 Hz	All set-ups	TRUE	-1	Int16
18-72	Mains Imbalance	0%	All set-ups	TRUE	-1	UInt16
18-75	Rectifier DC Volt.	0 V	All set-ups	TRUE	0	UInt16

4.1.17 20-** Drive Closed Loop

Parameter #	Parameter description	Default value	4 set-up	Change during operation	Conversion index	Type
20-0* Feedback						
20-00	Feedback 1 Source	[2] Analog Input 54	All set-ups	TRUE	-	Uint8
20-01	Feedback 1 Conversion	[0] Linear	All set-ups	FALSE	-	Uint8
20-02	Feedback 1 Source Unit	ExpressionLimit	All set-ups	TRUE	-	Uint8
20-03	Feedback 2 Source	[0] No function	All set-ups	TRUE	-	Uint8
20-04	Feedback 2 Conversion	[0] Linear	All set-ups	FALSE	-	Uint8
20-05	Feedback 2 Source Unit	ExpressionLimit	All set-ups	TRUE	-	Uint8
20-06	Feedback 3 Source	[0] No function	All set-ups	TRUE	-	Uint8
20-07	Feedback 3 Conversion	[0] Linear	All set-ups	FALSE	-	Uint8
20-08	Feedback 3 Source Unit	ExpressionLimit	All set-ups	TRUE	-	Uint8
20-12	Reference/Feedback Unit	ExpressionLimit	All set-ups	TRUE	-	Uint8
20-2* Feedback/Setpoint						
20-20	Feedback Function	[4] Maximum	All set-ups	TRUE	-	Uint8
20-21	Setpoint 1	0 ProcessCtrlUnit	All set-ups	TRUE	-3	Int32
20-22	Setpoint 2	0 ProcessCtrlUnit	All set-ups	TRUE	-3	Int32
20-23	Setpoint 3	0 ProcessCtrlUnit	All set-ups	TRUE	-3	Int32
20-6* Sensorless						
20-60	Sensorless Unit	ExpressionLimit	All set-ups	TRUE	-	Uint8
20-69	Sensorless Information	0 N/A	All set-ups	TRUE	0	VisStr[25]
20-7* PID Autotuning						
20-70	Closed Loop Type	[0] Auto	2 set-ups	TRUE	-	Uint8
20-71	PID Performance	[0] Normal	2 set-ups	TRUE	-	Uint8
20-72	PID Output Change	0.10 N/A	2 set-ups	TRUE	-2	Uint16
20-73	Minimum Feedback Level	-999999 ProcessCtrlUnit	2 set-ups	TRUE	-3	Int32
20-74	Maximum Feedback Level	999999 ProcessCtrlUnit	2 set-ups	TRUE	-3	Int32
20-79	PID Autotuning	[0] Disabled	All set-ups	TRUE	-	Uint8
20-8* PID Basic Settings						
20-81	PID Normal/ Inverse Control	[0] Normal	All set-ups	TRUE	-	Uint8
20-82	PID Start Speed [RPM]	ExpressionLimit	All set-ups	TRUE	67	Uint16
20-83	PID Start Speed [Hz]	ExpressionLimit	All set-ups	TRUE	-1	Uint16
20-84	On Reference Bandwidth	5%	All set-ups	TRUE	0	Uint8
20-9* PID Controller						
20-91	PID Anti Windup	[1] On	All set-ups	TRUE	-	Uint8
20-93	PID Proportional Gain	2 N/A	All set-ups	TRUE	-2	Uint16
20-94	PID Integral Time	8 s	All set-ups	TRUE	-2	Uint32
20-95	PID Differentiation Time	0 s	All set-ups	TRUE	-2	Uint16
20-96	PID Diff. Gain Limit	5 N/A	All set-ups	TRUE	-1	Uint16

4.1.18 21-** Ext. Closed Loop

Parameter #	Parameter description	Default value	4 set-up	Change during operation	Conversion index	Type
21-0* Ext. CL Autotuning						
21-00	Closed Loop Type	[0] Auto	2 set-ups	TRUE	-	Uint8
21-01	PID Performance	[0] Normal	2 set-ups	TRUE	-	Uint8
21-02	PID Output Change	0.10 N/A	2 set-ups	TRUE	-2	Uint16
21-03	Minimum Feedback Level	-999999 N/A	2 set-ups	TRUE	-3	Int32
21-04	Maximum Feedback Level	999999 N/A	2 set-ups	TRUE	-3	Int32
21-09	PID Auto Tuning	[0] Disabled	All set-ups	TRUE	-	Uint8
21-1* Ext. CL 1 Ref./Fb.						
21-10	Ext. 1 Ref./Feedback Unit	[0]	All set-ups	TRUE	-	Uint8
21-11	Ext. 1 Minimum Reference	0 ExtPID1Unit	All set-ups	TRUE	-3	Int32
21-12	Ext. 1 Maximum Reference	100 ExtPID1Unit	All set-ups	TRUE	-3	Int32
21-13	Ext. 1 Reference Source	[0] No function	All set-ups	TRUE	-	Uint8
21-14	Ext. 1 Feedback Source	[0] No function	All set-ups	TRUE	-	Uint8
21-15	Ext. 1 Setpoint	0 ExtPID1Unit	All set-ups	TRUE	-3	Int32
21-17	Ext. 1 Reference [Unit]	0 ExtPID1Unit	All set-ups	TRUE	-3	Int32
21-18	Ext. 1 Feedback [Unit]	0 ExtPID1Unit	All set-ups	TRUE	-3	Int32
21-19	Ext. 1 Output [%]	0%	All set-ups	TRUE	0	Int32
21-2* Ext. CL 1 PID						
21-20	Ext. 1 Normal/Inverse Control	[0] Normal	All set-ups	TRUE	-	Uint8
21-21	Ext. 1 Proportional Gain	0.50 N/A	All set-ups	TRUE	-2	Uint16
21-22	Ext. 1 Integral Time	20 s	All set-ups	TRUE	-2	Uint32
21-23	Ext. 1 Differentiation Time	0 s	All set-ups	TRUE	-2	Uint16
21-24	Ext. 1 Dif. Gain Limit	5 N/A	All set-ups	TRUE	-1	Uint16
21-3* Ext. CL 2 Ref./Fb.						
21-30	Ext. 2 Ref./Feedback Unit	[0]	All set-ups	TRUE	-	Uint8
21-31	Ext. 2 Minimum Reference	0 ExtPID2Unit	All set-ups	TRUE	-3	Int32
21-32	Ext. 2 Maximum Reference	100 ExtPID2Unit	All set-ups	TRUE	-3	Int32
21-33	Ext. 2 Reference Source	[0] No function	All set-ups	TRUE	-	Uint8
21-34	Ext. 2 Feedback Source	[0] No function	All set-ups	TRUE	-	Uint8
21-35	Ext. 2 Setpoint	0 ExtPID2Unit	All set-ups	TRUE	-3	Int32
21-37	Ext. 2 Reference [Unit]	0 ExtPID2Unit	All set-ups	TRUE	-3	Int32
21-38	Ext. 2 Feedback [Unit]	0 ExtPID2Unit	All set-ups	TRUE	-3	Int32
21-39	Ext. 2 Output [%]	0%	All set-ups	TRUE	0	Int32
21-4* Ext. CL 2 PID						
21-40	Ext. 2 Normal/Inverse Control	[0] Normal	All set-ups	TRUE	-	Uint8
21-41	Ext. 2 Proportional Gain	0.50 N/A	All set-ups	TRUE	-2	Uint16
21-42	Ext. 2 Integral Time	20 s	All set-ups	TRUE	-2	Uint32
21-43	Ext. 2 Differentiation Time	0 s	All set-ups	TRUE	-2	Uint16
21-44	Ext. 2 Dif. Gain Limit	5 N/A	All set-ups	TRUE	-1	Uint16
21-5* Ext. CL 3 Ref./Fb.						
21-50	Ext. 3 Ref./Feedback Unit	[0]	All set-ups	TRUE	-	Uint8
21-51	Ext. 3 Minimum Reference	0 ExtPID3Unit	All set-ups	TRUE	-3	Int32
21-52	Ext. 3 Maximum Reference	100 ExtPID3Unit	All set-ups	TRUE	-3	Int32
21-53	Ext. 3 Reference Source	[0] No function	All set-ups	TRUE	-	Uint8
21-54	Ext. 3 Feedback Source	[0] No function	All set-ups	TRUE	-	Uint8
21-55	Ext. 3 Setpoint	0 ExtPID3Unit	All set-ups	TRUE	-3	Int32
21-57	Ext. 3 Reference [Unit]	0 ExtPID3Unit	All set-ups	TRUE	-3	Int32

Parameter #	Parameter description	Default value	4 set-up	Change during operation	Conversion index	Type
21-58	Ext. 3 Feedback [Unit]	0 ExtPID3Unit	All set-ups	TRUE	-3	Int32
21-59	Ext. 3 Output [%]	0%	All set-ups	TRUE	0	Int32
21-6* Ext. CL 3 PID						
21-60	Ext. 3 Normal/Inverse Control	[0] Normal	All set-ups	TRUE	-	UInt8
21-61	Ext. 3 Proportional Gain	0.50 N/A	All set-ups	TRUE	-2	UInt16
21-62	Ext. 3 Integral Time	20 s	All set-ups	TRUE	-2	UInt32
21-63	Ext. 3 Differentiation Time	0 s	All set-ups	TRUE	-2	UInt16
21-64	Ext. 3 Dif. Gain Limit	5 N/A	All set-ups	TRUE	-1	UInt16

4.1.19 22-** Appl. Functions

Parameter #	Parameter description	Default value	4 set-up	Change during operation	Conversion index	Type
22-0* Miscellaneous						
22-00	External Interlock Delay	0 s	All set-ups	TRUE	0	Uint16
22-01	Power Filter Time	0.50 s	2 set-ups	TRUE	-2	Uint16
22-2* No-Flow Detection						
22-20	Low Power Auto Set-up	[0] Off	All set-ups	FALSE	-	Uint8
22-21	Low Power Detection	[0] Disabled	All set-ups	TRUE	-	Uint8
22-22	Low Speed Detection	[0] Disabled	All set-ups	TRUE	-	Uint8
22-23	No-Flow Function	[0] Off	All set-ups	TRUE	-	Uint8
22-24	No-Flow Delay	10 s	All set-ups	TRUE	0	Uint16
22-26	Dry Pump Function	[0] Off	All set-ups	TRUE	-	Uint8
22-27	Dry Pump Delay	10 s	All set-ups	TRUE	0	Uint16
22-28	No-Flow Low Speed [RPM]	ExpressionLimit	All set-ups	TRUE	67	Uint16
22-29	No-Flow Low Speed [Hz]	ExpressionLimit	All set-ups	TRUE	-1	Uint16
22-3* No-Flow Power Tuning						
22-30	No-Flow Power	0 kW	All set-ups	TRUE	1	Uint32
22-31	Power Correction Factor	100%	All set-ups	TRUE	0	Uint16
22-32	Low Speed [RPM]	ExpressionLimit	All set-ups	TRUE	67	Uint16
22-33	Low Speed [Hz]	ExpressionLimit	All set-ups	TRUE	-1	Uint16
22-34	Low Speed Power [kW]	ExpressionLimit	All set-ups	TRUE	1	Uint32
22-35	Low Speed Power [HP]	ExpressionLimit	All set-ups	TRUE	-2	Uint32
22-36	High Speed [RPM]	ExpressionLimit	All set-ups	TRUE	67	Uint16
22-37	High Speed [Hz]	ExpressionLimit	All set-ups	TRUE	-1	Uint16
22-38	High Speed Power [kW]	ExpressionLimit	All set-ups	TRUE	1	Uint32
22-39	High Speed Power [HP]	ExpressionLimit	All set-ups	TRUE	-2	Uint32
22-4* Sleep Mode						
22-40	Minimum Run Time	60 s	All set-ups	TRUE	0	Uint16
22-41	Minimum Sleep Time	30 s	All set-ups	TRUE	0	Uint16
22-42	Wake-up Speed [RPM]	ExpressionLimit	All set-ups	TRUE	67	Uint16
22-43	Wake-up Speed [Hz]	ExpressionLimit	All set-ups	TRUE	-1	Uint16
22-44	Wake-up Ref./FB Difference	10%	All set-ups	TRUE	0	Int8
22-45	Setpoint Boost	0%	All set-ups	TRUE	0	Int8
22-46	Maximum Boost Time	60 s	All set-ups	TRUE	0	Uint16
22-5* End of Curve						
22-50	End of Curve Function	[0] Off	All set-ups	TRUE	-	Uint8
22-51	End of Curve Delay	10 s	All set-ups	TRUE	0	Uint16
22-6* Broken Belt Detection						
22-60	Broken Belt Function	[0] Off	All set-ups	TRUE	-	Uint8
22-61	Broken Belt Torque	10%	All set-ups	TRUE	0	Uint8
22-62	Broken Belt Delay	10 s	All set-ups	TRUE	0	Uint16
22-7* Short Cycle Protection						
22-75	Short Cycle Protection	[0] Disabled	All set-ups	TRUE	-	Uint8
22-76	Interval between Starts	start_to_start_min_on_time (P2277)	All set-ups	TRUE	0	Uint16
22-77	Minimum Run Time	0 s	All set-ups	TRUE	0	Uint16
22-78	Minimum Run Time Override	[0] Disabled	All set-ups	FALSE	-	Uint8
22-79	Minimum Run Time Override Value	0 ProcessCtrlUnit	All set-ups	TRUE	-3	Int32
22-8* Flow Compensation						

Parameter #	Parameter description	Default value	4 set-up	Change during operation	Conversion index	Type
22-80	Flow Compensation	[0] Disabled	All set-ups	TRUE	-	UInt8
22-81	Square-linear Curve Approximation	100%	All set-ups	TRUE	0	UInt8
22-82	Work Point Calculation	[0] Disabled	All set-ups	TRUE	-	UInt8
22-83	Speed at No-Flow [RPM]	ExpressionLimit	All set-ups	TRUE	67	UInt16
22-84	Speed at No-Flow [Hz]	ExpressionLimit	All set-ups	TRUE	-1	UInt16
22-85	Speed at Design Point [RPM]	ExpressionLimit	All set-ups	TRUE	67	UInt16
22-86	Speed at Design Point [Hz]	ExpressionLimit	All set-ups	TRUE	-1	UInt16
22-87	Pressure at No-Flow Speed	0 N/A	All set-ups	TRUE	-3	Int32
22-88	Pressure at Rated Speed	999999.999 N/A	All set-ups	TRUE	-3	Int32
22-89	Flow at Design Point	0 N/A	All set-ups	TRUE	-3	Int32
22-90	Flow at Rated Speed	0 N/A	All set-ups	TRUE	-3	Int32

4.1.20 23-** Time-based Functions

Parameter #	Parameter description	Default value	4 set-up	Change during operation	Conversion index	Type
23-0* Timed Actions						
23-00	ON Time	ExpressionLimit	2 set-ups	TRUE	0	TimeOfDay-WoDate
23-01	ON Action	[0] Disabled	2 set-ups	TRUE	-	UInt8
23-02	OFF Time	ExpressionLimit	2 set-ups	TRUE	0	TimeOfDay-WoDate
23-03	OFF Action	[0] Disabled	2 set-ups	TRUE	-	UInt8
23-04	Occurrence	[0] All days	2 set-ups	TRUE	-	UInt8
23-1* Maintenance						
23-10	Maintenance Item	[1] Motor bearings	1 set-up	TRUE	-	UInt8
23-11	Maintenance Action	[1] Lubricate	1 set-up	TRUE	-	UInt8
23-12	Maintenance Time Base	[0] Disabled	1 set-up	TRUE	-	UInt8
23-13	Maintenance Time Interval	1 h	1 set-up	TRUE	74	UInt32
23-14	Maintenance Date and Time	ExpressionLimit	1 set-up	TRUE	0	TimeOfDay
23-1* Maintenance Reset						
23-15	Reset Maintenance Word	[0] Do not reset	All set-ups	TRUE	-	UInt8
23-16	Maintenance Text	0 N/A	1 set-up	TRUE	0	VisStr[20]
23-5* Energy Log						
23-50	Energy Log Resolution	[5] Last 24 Hours	2 set-ups	TRUE	-	UInt8
23-51	Period Start	ExpressionLimit	2 set-ups	TRUE	0	TimeOfDay
23-53	Energy Log	0 N/A	All set-ups	TRUE	0	UInt32
23-54	Reset Energy Log	[0] Do not reset	All set-ups	TRUE	-	UInt8
23-6* Trending						
23-60	Trend Variable	[2] Frequency [Hz]	2 set-ups	TRUE	-	UInt8
23-61	Continuous Bin Data	0 N/A	All set-ups	TRUE	0	UInt32
23-62	Timed Bin Data	0 N/A	All set-ups	TRUE	0	UInt32
23-63	Timed Period Start	ExpressionLimit	2 set-ups	TRUE	0	TimeOfDay
23-64	Timed Period Stop	ExpressionLimit	2 set-ups	TRUE	0	TimeOfDay
23-65	Minimum Bin Value	ExpressionLimit	2 set-ups	TRUE	0	UInt8
23-66	Reset Continuous Bin Data	[0] Do not reset	All set-ups	TRUE	-	UInt8
23-67	Reset Timed Bin Data	[0] Do not reset	All set-ups	TRUE	-	UInt8
23-8* Payback Counter						
23-80	Power Reference Factor	100%	2 set-ups	TRUE	0	UInt8
23-81	Energy Cost	1 N/A	2 set-ups	TRUE	-2	UInt32
23-82	Investment	0 N/A	2 set-ups	TRUE	0	UInt32
23-83	Energy Savings	0 kWh	All set-ups	TRUE	75	Int32
23-84	Cost Savings	0 N/A	All set-ups	TRUE	0	Int32

4.1.21 24-** Appl. Functions 2

Parameter #	Parameter description	Default value	4 set-up	Change during operation	Conversion index	Type
24-1* Drive Bypass						
24-10	Drive Bypass Function	[0] Disabled	2 set-ups	TRUE	-	Uint8
24-11	Drive Bypass Delay Time	0 s	2 set-ups	TRUE	0	Uint16

4.1.22 25-** Cascade Controller

Parameter #	Parameter description	Default value	4 set-up	Change during operation	Conversion index	Type
25-0* System Settings						
25-00	Cascade Controller	ExpressionLimit	2 set-ups	FALSE	-	Uint8
25-02	Motor Start	[0] Direct on Line	2 set-ups	FALSE	-	Uint8
25-04	Pump Cycling	ExpressionLimit	All set-ups	TRUE	-	Uint8
25-05	Fixed Lead Pump	ExpressionLimit	2 set-ups	FALSE	-	Uint8
25-06	Number of Pumps	2 N/A	2 set-ups	FALSE	0	Uint8
25-2* Bandwidth Settings						
25-20	Staging Bandwidth	ExpressionLimit	All set-ups	TRUE	0	Uint8
25-21	Override Bandwidth	100%	All set-ups	TRUE	0	Uint8
25-22	Fixed Speed Bandwidth	casco_staging_bandwidth (P2520)	All set-ups	TRUE	0	Uint8
25-23	SBW Staging Delay	15 s	All set-ups	TRUE	0	Uint16
25-24	SBW Destaging Delay	15 s	All set-ups	TRUE	0	Uint16
25-25	OBW Time	10 s	All set-ups	TRUE	0	Uint16
25-26	Destage At No-Flow	[0] Disabled	All set-ups	TRUE	-	Uint8
25-27	Stage Function	ExpressionLimit	All set-ups	TRUE	-	Uint8
25-28	Stage Function Time	15 s	All set-ups	TRUE	0	Uint16
25-29	Destage Function	ExpressionLimit	All set-ups	TRUE	-	Uint8
25-30	Destage Function Time	15 s	All set-ups	TRUE	0	Uint16
25-4* Staging Settings						
25-40	Ramp Down Delay	10 s	All set-ups	TRUE	-1	Uint16
25-41	Ramp Up Delay	2 s	All set-ups	TRUE	-1	Uint16
25-42	Staging Threshold	ExpressionLimit	All set-ups	TRUE	0	Uint8
25-43	Destaging Threshold	ExpressionLimit	All set-ups	TRUE	0	Uint8
25-44	Staging Speed [RPM]	0 RPM	All set-ups	TRUE	67	Uint16
25-45	Staging Speed [Hz]	0 Hz	All set-ups	TRUE	-1	Uint16
25-46	Destaging Speed [RPM]	0 RPM	All set-ups	TRUE	67	Uint16
25-47	Destaging Speed [Hz]	0 Hz	All set-ups	TRUE	-1	Uint16
25-49	Staging Principle	[0] Normal	All set-ups	FALSE	-	Uint8
25-5* Alternation Settings						
25-50	Lead Pump Alternation	ExpressionLimit	All set-ups	TRUE	-	Uint8
25-51	Alternation Event	[0] External	All set-ups	TRUE	-	Uint8
25-52	Alternation Time Interval	24 h	All set-ups	TRUE	74	Uint16
25-53	Alternation Timer Value	0 N/A	All set-ups	TRUE	0	VisStr[7]
25-54	Alternation Predefined Time	ExpressionLimit	All set-ups	TRUE	0	TimeOfDay-WoDate
25-55	Alternate if Load < 50%	[1] Enabled	All set-ups	TRUE	-	Uint8
25-56	Staging Mode at Alternation	[0] Slow	All set-ups	TRUE	-	Uint8
25-58	Run Next Pump Delay	0.1 s	All set-ups	TRUE	-1	Uint16

Parameter #	Parameter description	Default value	4 set-up	Change during operation	Conversion index	Type
25-59	Run on Mains Delay	0.5 s	All set-ups	TRUE	-1	Uint16
25-8* Status						
25-80	Cascade Status	0 N/A	All set-ups	TRUE	0	VisStr[25]
25-81	Pump Status	0 N/A	All set-ups	TRUE	0	VisStr[25]
25-82	Lead Pump	0 N/A	All set-ups	TRUE	0	Uint8
25-83	Relay Status	0 N/A	All set-ups	TRUE	0	VisStr[4]
25-84	Pump ON Time	0 h	All set-ups	TRUE	74	Uint32
25-85	Relay ON Time	0 h	All set-ups	TRUE	74	Uint32
25-86	Reset Relay Counters	[0] Do not reset	All set-ups	TRUE	-	Uint8
25-9* Service						
25-90	Pump Interlock	[0] Off	All set-ups	TRUE	-	Uint8
25-91	Manual Alternation	0 N/A	All set-ups	TRUE	0	Uint8

4.1.23 26-** Analog I/O Option

Parameter #	Parameter description	Default value	4 set-up	Change during operation	Conversion index	Type
26-0* Analog I/O Mode						
26-00	Terminal X42/1 Mode	[1] Voltage	All set-ups	TRUE	-	Uint8
26-01	Terminal X42/3 Mode	[1] Voltage	All set-ups	TRUE	-	Uint8
26-02	Terminal X42/5 Mode	[1] Voltage	All set-ups	TRUE	-	Uint8
26-1* Analog Input X42/1						
26-10	Terminal X42/1 Low Voltage	0.07 V	All set-ups	TRUE	-2	Int16
26-11	Terminal X42/1 High Voltage	10 V	All set-ups	TRUE	-2	Int16
26-14	Term. X42/1 Low Ref./Feedb. Value	0 N/A	All set-ups	TRUE	-3	Int32
26-15	Term. X42/1 High Ref./Feedb. Value	100 N/A	All set-ups	TRUE	-3	Int32
26-16	Term. X42/1 Filter Time Constant	0.001 s	All set-ups	TRUE	-3	Uint16
26-17	Term. X42/1 Live Zero	[1] Enabled	All set-ups	TRUE	-	Uint8
26-2* Analog Input X42/3						
26-20	Terminal X42/3 Low Voltage	0.07 V	All set-ups	TRUE	-2	Int16
26-21	Terminal X42/3 High Voltage	10 V	All set-ups	TRUE	-2	Int16
26-24	Term. X42/3 Low Ref./Feedb. Value	0 N/A	All set-ups	TRUE	-3	Int32
26-25	Term. X42/3 High Ref./Feedb. Value	100 N/A	All set-ups	TRUE	-3	Int32
26-26	Term. X42/3 Filter Time Constant	0.001 s	All set-ups	TRUE	-3	Uint16
26-27	Term. X42/3 Live Zero	[1] Enabled	All set-ups	TRUE	-	Uint8
26-3* Analog Input X42/5						
26-30	Terminal X42/5 Low Voltage	0.07 V	All set-ups	TRUE	-2	Int16
26-31	Terminal X42/5 High Voltage	10 V	All set-ups	TRUE	-2	Int16
26-34	Term. X42/5 Low Ref./Feedb. Value	0 N/A	All set-ups	TRUE	-3	Int32
26-35	Term. X42/5 High Ref./Feedb. Value	100 N/A	All set-ups	TRUE	-3	Int32
26-36	Term. X42/5 Filter Time Constant	0.001 s	All set-ups	TRUE	-3	Uint16
26-37	Term. X42/5 Live Zero	[1] Enabled	All set-ups	TRUE	-	Uint8
26-4* Analog Out X42/7						
26-40	Terminal X42/7 Output	[0] No operation	All set-ups	TRUE	-	Uint8
26-41	Terminal X42/7 Min. Scale	0%	All set-ups	TRUE	-2	Int16
26-42	Terminal X42/7 Max. Scale	100%	All set-ups	TRUE	-2	Int16
26-43	Terminal X42/7 Bus Control	0%	All set-ups	TRUE	-2	N2
26-44	Terminal X42/7 Timeout Preset	0%	1 set-up	TRUE	-2	Uint16
26-5* Analog Out X42/9						

Parameter #	Parameter description	Default value	4 set-up	Change during operation	Conversion index	Type
26-50	Terminal X42/9 Output	[0] No operation	All set-ups	TRUE	-	Uint8
26-51	Terminal X42/9 Min. Scale	0%	All set-ups	TRUE	-2	Int16
26-52	Terminal X42/9 Max. Scale	100%	All set-ups	TRUE	-2	Int16
26-53	Terminal X42/9 Bus Control	0%	All set-ups	TRUE	-2	N2
26-54	Terminal X42/9 Timeout Preset	0%	1 set-up	TRUE	-2	Uint16
26-6* Analog Out X42/11						
26-60	Terminal X42/11 Output	[0] No operation	All set-ups	TRUE	-	Uint8
26-61	Terminal X42/11 Min. Scale	0%	All set-ups	TRUE	-2	Int16
26-62	Terminal X42/11 Max. Scale	100%	All set-ups	TRUE	-2	Int16
26-63	Terminal X42/11 Bus Control	0%	All set-ups	TRUE	-2	N2
26-64	Terminal X42/11 Timeout Preset	0%	1 set-up	TRUE	-2	Uint16

4.1.24 29-** Water Application Functions

Parameter #	Parameter description	Default value	4 set-up	Change during operation	Conversion index	Type
29-0* Pipe Fill						
29-00	Pipe Fill Enable	[0] Disabled	2 set-ups	FALSE	-	Uint8
29-01	Pipe Fill Speed [RPM]	ExpressionLimit	All set-ups	TRUE	67	Uint16
29-02	Pipe Fill Speed [Hz]	ExpressionLimit	All set-ups	TRUE	-1	Uint16
29-03	Pipe Fill Time	0 s	All set-ups	TRUE	-2	Uint32
29-04	Pipe Fill Rate	0.001 ProcessCtrlUnit	All set-ups	TRUE	-3	Int32
29-05	Filled Setpoint	0 ProcessCtrlUnit	All set-ups	TRUE	-3	Int32
29-06	No-Flow Disable Timer	0 s	All set-ups	TRUE	-2	Uint32
29-07	Filled setpoint delay	0 s	All set-ups	TRUE	-1	Uint16
29-1* Deragging Function						
29-10	Derag Cycles	ExpressionLimit	2 set-ups	FALSE	0	Uint32
29-11	Derag at Start/Stop	[0] Off	1 set-up	TRUE	-	Uint8
29-12	Deragging Run Time	0 s	All set-ups	TRUE	0	Uint16
29-13	Derag Speed [RPM]	ExpressionLimit	All set-ups	TRUE	67	Uint16
29-14	Derag Speed [Hz]	ExpressionLimit	All set-ups	TRUE	-1	Uint16
29-15	Derag Off Delay	10 s	All set-ups	TRUE	0	Uint16
29-2* Derag Power Tuning						
29-20	Derag Power[kW]	0 kW	All set-ups	TRUE	1	Uint32
29-21	Derag Power[HP]	0 hp	All set-ups	TRUE	-2	Uint32
29-22	Derag Power Factor	200%	All set-ups	TRUE	0	Uint16
29-23	Derag Power Delay	601 s	All set-ups	TRUE	0	Uint16
29-24	Low Speed [RPM]	ExpressionLimit	All set-ups	TRUE	67	Uint16
29-25	Low Speed [Hz]	ExpressionLimit	All set-ups	TRUE	-1	Uint16
29-26	Low Speed Power [kW]	ExpressionLimit	All set-ups	TRUE	1	Uint32
29-27	Low Speed Power [HP]	ExpressionLimit	All set-ups	TRUE	-2	Uint32
29-28	High Speed [RPM]	ExpressionLimit	All set-ups	TRUE	67	Uint16
29-29	High Speed [Hz]	ExpressionLimit	All set-ups	TRUE	-1	Uint16
29-30	High Speed Power [kW]	ExpressionLimit	All set-ups	TRUE	1	Uint32
29-31	High Speed Power [HP]	ExpressionLimit	All set-ups	TRUE	-2	Uint32
29-32	Derag On Ref Bandwidth	5%	All set-ups	TRUE	0	Uint8
29-33	Power Derag Limit	3 N/A	2 set-ups	FALSE	0	Uint8
29-34	Consecutive Derag Interval	ExpressionLimit	All set-ups	FALSE	0	Uint16
29-35	Derag at Locked Rotor	[0] Disabled	All set-ups	TRUE	-	Uint8
29-4* Pre/Post Lube						
29-40	Pre/Post Lube Function	[0] Disabled	All set-ups	TRUE	-	Uint8
29-41	Pre Lube Time	10 s	All set-ups	TRUE	0	Uint16
29-42	Post Lube Time	10 s	All set-ups	TRUE	0	Uint16
29-5* Flow Confirmation						
29-50	Validation Time	ExpressionLimit	All set-ups	TRUE	-2	Uint32
29-51	Verification Time	15 s	All set-ups	TRUE	-2	Uint32
29-52	Signal Lost Verification Time	1 s	All set-ups	TRUE	-2	Uint32
29-53	Flow Confirmation Mode	[0] Confirmation Only	All set-ups	FALSE	-	Uint8
29-6* Flow Meter						
29-60	Flow Meter Monitor	[0] Disabled	All set-ups	TRUE	-	Uint8
29-61	Flow Meter Source	[0] Analog Input 53	All set-ups	TRUE	-	Uint8

Parameter #	Parameter description	Default value	4 set-up	Change during operation	Conversion index	Type
29-62	Flow Meter Unit	[0] l/s	All set-ups	TRUE	-	Uint8
29-63	Totalized Volume Unit	[0] Disabled	All set-ups	TRUE	-	Uint8
29-64	Actual Volume Unit	[0] Disabled	All set-ups	TRUE	-	Uint8
29-65	Totalized Volume	0 TotalizedVolumeUnit	All set-ups	FALSE	0	Uint32
29-66	Actual Volume	0.00 ActualVolumeUnit	All set-ups	FALSE	-2	Uint32
29-67	Reset Totalized Volume	[0] Do not reset	All set-ups	TRUE	-	Uint8
29-68	Reset Actual Volume	[0] Do not reset	All set-ups	TRUE	-	Uint8
29-69	Flow	0 FlowMeterUnit	All set-ups	FALSE	0	Uint32

4.1.25 30-** Special Features

Parameter #	Parameter description	Default value	4 set-up	Change during operation	Conversion index	Type
30-2* Adv. Start Adjust						
30-22	Locked Rotor Detection	ExpressionLimit	All set-ups	TRUE	-	Uint8
30-23	Locked Rotor Detection Time [s]	ExpressionLimit	All set-ups	TRUE	-2	Uint8
30-5* Unit Configuration						
30-50	Heat Sink Fan Mode	ExpressionLimit	2 set-ups	TRUE	-	uint8
30-8* Compatibility (I)						
30-81	Brake Resistor (ohm)	ExpressionLimit	All set-ups	TRUE	-2	Uint32

4.1.26 31-** Bypass Option

Parameter #	Parameter description	Default value	4 set-up	Change during operation	Conversion index	Type
31-00	Bypass Mode	[0] Drive	All set-ups	TRUE	-	Uint8
31-01	Bypass Start Time Delay	30 s	All set-ups	TRUE	0	Uint16
31-02	Bypass Trip Time Delay	0 s	All set-ups	TRUE	0	Uint16
31-03	Test Mode Activation	[0] Disabled	All set-ups	TRUE	-	Uint8
31-10	Bypass Status Word	0 N/A	All set-ups	FALSE	0	V2
31-11	Bypass Running Hours	0 h	All set-ups	FALSE	74	Uint32
31-19	Remote Bypass Activation	[0] Disabled	2 set-ups	TRUE	-	Uint8

4.1.27 35-** Sensor Input Option

Parameter #	Parameter description	Default value	4 set-up	Change during operation	Conversion index	Type
35-0* Temp. Input Mode						
35-00	Term. X48/4 Temperature Unit	[60] °C	All set-ups	TRUE	-	Uint8
35-01	Term. X48/4 Input Type	[0] Not Connected	All set-ups	TRUE	-	Uint8
35-02	Term. X48/7 Temperature Unit	[60] °C	All set-ups	TRUE	-	Uint8
35-03	Term. X48/7 Input Type	[0] Not Connected	All set-ups	TRUE	-	Uint8
35-04	Term. X48/10 Temperature Unit	[60] °C	All set-ups	TRUE	-	Uint8
35-05	Term. X48/10 Input Type	[0] Not Connected	All set-ups	TRUE	-	Uint8
35-06	Temperature Sensor Alarm Function	[5] Stop and trip	All set-ups	TRUE	-	Uint8
35-1* Temp. Input X48/4						
35-14	Term. X48/4 Filter Time Constant	0.001 s	All set-ups	TRUE	-3	Uint16
35-15	Term. X48/4 Temp. Monitor	[0] Disabled	All set-ups	TRUE	-	Uint8
35-16	Term. X48/4 Low Temp. Limit	ExpressionLimit	All set-ups	TRUE	0	Int16
35-17	Term. X48/4 High Temp. Limit	ExpressionLimit	All set-ups	TRUE	0	Int16
35-2* Temp. Input X48/7						
35-24	Term. X48/7 Filter Time Constant	0.001 s	All set-ups	TRUE	-3	Uint16
35-25	Term. X48/7 Temp. Monitor	[0] Disabled	All set-ups	TRUE	-	Uint8
35-26	Term. X48/7 Low Temp. Limit	ExpressionLimit	All set-ups	TRUE	0	Int16
35-27	Term. X48/7 High Temp. Limit	ExpressionLimit	All set-ups	TRUE	0	Int16
35-3* Temp. Input X48/10						
35-34	Term. X48/10 Filter Time Constant	0.001 s	All set-ups	TRUE	-3	Uint16
35-35	Term. X48/10 Temp. Monitor	[0] Disabled	All set-ups	TRUE	-	Uint8
35-36	Term. X48/10 Low Temp. Limit	ExpressionLimit	All set-ups	TRUE	0	Int16
35-37	Term. X48/10 High Temp. Limit	ExpressionLimit	All set-ups	TRUE	0	Int16

Parameter #	Parameter description	Default value	4 set-up	Change during operation	Conversion index	Type
35-4* Analog Input X48/2						
35-42	Term. X48/2 Low Current	4 mA	All set-ups	TRUE	-5	Int16
35-43	Term. X48/2 High Current	20 mA	All set-ups	TRUE	-5	Int16
35-44	Term. X48/2 Low Ref./Feedb. Value	0 N/A	All set-ups	TRUE	-3	Int32
35-45	Term. X48/2 High Ref./Feedb. Value	100 N/A	All set-ups	TRUE	-3	Int32
35-46	Term. X48/2 Filter Time Constant	0.001 s	All set-ups	TRUE	-3	Uint16
35-47	Term. X48/2 Live Zero	[1] Enabled	All set-ups	TRUE	-	Uint8

5 Troubleshooting

5.1 Status Messages

5.1.1 Warnings/Alarm Messages

A warning or an alarm is signaled by the relevant LED on the front of the frequency converter and indicated by a code on the display.

A warning remains active until its cause is no longer present. Under certain circumstances, operation of the motor may still continue. Warning messages may be critical, but are not necessarily so.

An alarm trips the frequency converter. Reset alarms to restart operation once their cause has been rectified.

This can be done in 3 ways

- By pressing [Reset].
- Via a digital input with the reset function.
- Via serial communication/optional fieldbus.

NOTICE!

After a manual reset pressing [Reset], press [Auto On] to restart the motor.

If an alarm cannot be reset, its cause may not have been rectified, or the alarm is trip-locked (see also *Table 5.1*).

Alarms that are trip-locked offer extra protection, meaning that the mains supply must be switched off before the

alarm can be reset. After being switched back on, the frequency converter is no longer blocked and may be reset as described above once the cause has been rectified.

Alarms that are not trip-locked can also be reset using the automatic reset function in *parameter 14-20 Reset Mode*.

NOTICE!

Automatic wake-up is possible!

If a warning and alarm are marked against a code in *Table 5.1*, this means that either a warning occurs before an alarm, or else that it is possible to specify whether it is a warning or an alarm that is to be shown for a given fault.

This is possible, for instance, in *parameter 1-90 Motor Thermal Protection*. After an alarm or trip, the motor carries on coasting, and the alarm and warning flash. Once the problem has been rectified, only the alarm continues flashing until the frequency converter is reset.

NOTICE!

No missing motor phase detection (numbers 30–32) and no stall detection is active when *parameter 1-10 Motor Construction* is set to [1] *PM non-salient SPM*.

Num-ber	Description	Warning	Alarm/Trip	Alarm/Trip Lock	Parameter reference
1	10 volts low	X	–	–	
2	Live zero error	(X)	(X)	–	<i>Parameter 6-01 Live Zero Timeout Function</i>
3	No motor	(X)	–	–	<i>Parameter 1-80 Function at Stop</i>
4	Mains phase loss	(X)	(X)	(X)	<i>Parameter 14-12 Function at Mains Imbalance</i>
5	DC-link voltage high	X	–	–	–
6	DC-link voltage low	X	–	–	–
7	DC overvoltage	X	X	–	–
8	DC undervoltage	X	X	–	–
9	Inverter overloaded	X	X	–	–
10	Motor ETR overtemperature	(X)	(X)	–	<i>Parameter 1-90 Motor Thermal Protection</i>

Number	Description	Warning	Alarm/Trip	Alarm/Trip Lock	Parameter reference
11	Motor thermistor overtemperature	(X)	(X)	–	Parameter 1-90 Motor Thermal Protection
12	Torque limit	X	X	–	–
13	Overcurrent	X	X	X	–
14	Ground fault	X	X	X	–
15	Hardware mismatch	–	X	X	–
16	Short circuit	–	X	X	–
17	Control word timeout	(X)	(X)	–	Parameter 8-04 Control Word Timeout Function
18	Start failed		X	–	Parameter 1-77 Compressor Start Max Speed [RPM] and parameter 1-79 Pump Start Max Time to Trip
20	Temperature input error	–	–	–	–
21	Parameter error	–	–	–	–
22	Hoist mechanical brake	(X)	(X)		Parameter group 2-2* No-Flow Detection
23	Internal fans	X	–	–	–
24	External fans	X	–	–	–
25	Brake resistor short-circuited	X	–	–	–
26	Brake resistor power limit	(X)	(X)	–	Parameter 2-13 Brake Power Monitoring
27	Brake chopper short-circuited	X	X	–	
28	Brake check	(X)	(X)	–	Parameter 2-15 Brake Check
29	Heat sink temp	X	X	X	
30	Motor phase U missing	(X)	(X)	(X)	Parameter 4-58 Missing Motor Phase Function
31	Motor phase V missing	(X)	(X)	(X)	Parameter 4-58 Missing Motor Phase Function
32	Motor phase W missing	(X)	(X)	(X)	Parameter 4-58 Missing Motor Phase Function
33	Inrush fault	–	X	X	–
34	Fieldbus communication fault	X	X	–	–
35	Option fault		–	–	–
36	Mains failure	X	X	–	–
37	Phase imbalance	–	X	–	–
38	Internal fault	–	X	X	–
39	Heat sink sensor	–	X	X	–
40	Overload of digital output terminal 27	(X)	–	–	Parameter 5-00 Digital I/O Mode, parameter 5-01 Terminal 27 Mode
41	Overload of digital output terminal 29	(X)	–	–	Parameter 5-00 Digital I/O Mode, parameter 5-02 Terminal 29 Mode
42	OvrlD X30/6-7	(X)	–	–	–
43	External supply (option)		–	–	–
45	Ground fault 2	X	X	X	–
46	Pwr. card supply		X	X	–
47	24 V supply low	X	X	X	–

Num-ber	Description	Warning	Alarm/Trip	Alarm/Trip Lock	Parameter reference
48	1.8 V supply low	-	X	X	-
49	Speed limit	-	X	-	Parameter 1-86 Trip Speed Low [RPM]
50	AMA calibration failed	-	X	-	-
51	AMA check U _{nom} and I _{nom}	-	X	-	-
52	AMA low I _{nom}	-	X	-	-
53	AMA motor too big	-	X	-	-
54	AMA motor too small	-	X	-	-
55	AMA parameter out of range	-	X	-	-
56	AMA interrupted by user	-	X	-	-
57	AMA timeout	-	X	-	-
58	AMA internal fault	X	X	-	-
59	Current limit	X	-	-	-
60	External interlock	X	X	-	-
61	Feedback error	(X)	(X)	-	-
62	Output frequency at maximum limit	X	-	-	-
63	Mechanical brake low	-	(X)	-	-
64	Voltage limit	X	-	-	-
65	Control board overtemperature	X	X	X	-
66	Heat sink temperature low	X	-	-	-
67	Option configuration has changed	-	X	-	-
68	Safe Torque Off	(X)	(X) ¹⁾	-	Parameter 5-19 Terminal 37 Safe Stop
69	Pwr. card temp	-	X	X	-
70	Illegal FC configuration	-	-	X	-
71	PTC 1 Safe Torque Off	-	-	-	-
72	Dangerous failure	-	-	-	-
73	Safe Torque Off auto restart	(X)	(X)	-	Parameter 5-19 Terminal 37 Safe Stop
74	PTC thermistor	-	-	X	-
75	Illegal profile sel.	-	X	-	-
76	Power unit set-up	X	-	-	-
77	Reduced power mode	X	-	-	Parameter 14-59 Actual Number of Inverter Units
78	Tracking error	(X)	(X)	-	-
79	Illegal PS config	-	X	X	-
80	Frequency converter initialized to default value	-	X	-	-
81	CSIV corrupt	-	X	-	-
82	CSIV parameter error	-	X	-	-
83	Illegal option combination	-	-	X	-
84	No safety option	-	X	-	-
88	Option detection	-	-	X	-
89	Mechanical brake sliding	X	-	-	-
90	Feedback monitor	(X)	(X)	-	-
91	Analog input 54 wrong settings	-	-	X	S202
92	No-flow	(X)	(X)	-	Parameter 22-23 No-Flow Function

Number	Description	Warning	Alarm/Trip	Alarm/Trip Lock	Parameter reference
93	Dry pump	(X)	(X)	(X)	Parameter 22-26 Dry Pump Function
94	End of curve	(X)	(X)	(X)	Parameter 22-50 End of Curve Function
95	Broken belt	(X)	(X)	(X)	Parameter 22-60 Broken Belt Function
98	Clock fault	(X)	(X)	(X)	Parameter 0-79 Clock Fault
163	ATEX ETR cur.lim.warning	X	-	-	-
164	ATEX ETR cur.lim.alarm	-	X	-	-
165	ATEX ETR freq.lim.warning	X	-	-	-
166	ATEX ETR freq.lim.alarm	-	X	-	-
200	Emergency mode	-	-	-	Parameter 24-00 Emergency Mode Function
201	Emergency mode was active	-	-	-	Parameter 24-00 Emergency Mode Function
250	New spare parts	-	-	X	-
251	New type code	-	X	X	-

Table 5.1 Alarm/Warning Code List

(X) Dependent on parameter.

1) Cannot be auto reset via parameter 14-20 Reset Mode.

A trip is the action when an alarm has appeared. The trip coasts the motor and can be reset by pressing [Reset] or make a reset by a digital input (*parameter group 5-1* Digital Inputs* [1]). The event that caused an alarm cannot damage the frequency converter or cause dangerous conditions. A trip lock is an action when an alarm occurs that may damage the frequency converter or connected parts. A trip lock situation can only be reset by a power cycling.

Warning	yellow
Alarm	flashing red
Trip locked	yellow and red

Table 5.2 LED Indication

Bit	Hex	Dec	Alarm word	Alarm word 2	Warning word	Warning word 2	Extended status word	Extended status word 2
Alarm word extended status word								
0	00000001	1	Brake check (A28)	ServiceTrip, Read/Write	Brake check (W28)	Reserved	Ramping.	Off
1	00000002	2	Heat sink temp. (A29)	ServiceTrip, (reserved)	Heat sink temp. (W29)	Reserved	AMA Running.	Hand/auto
2	00000004	4	Ground fault (A14)	ServiceTrip, Typecode/ Sparepart	Earth fault (W14)	Clock Failure	Start CW/CCW start_possible is active, when the DI selections [12] OR [13] are active and the requested direction matches the reference sign.	Not used

Bit	Hex	Dec	Alarm word	Alarm word 2	Warning word	Warning word 2	Extended status word	Extended status word 2
Alarm word extended status word								
3	00000008	8	Ctrl.Card Temp (A65)	ServiceTrip, (reserved)	Ctrl.Card Temp (W65)	Reserved	Slow-down command active, for example via CTW bit 11 or DI.	Not used
4	00000010	16	Ctrl. Word TO (A17)	ServiceTrip, (reserved)	Ctrl. Word TO (W17)		Catch-up command active, for example via CTW bit 12 or DI.	Not used
5	00000020	32	Over Current (A13)	Reserved	Over Current (W13)	Reserved	Feedback high. Feedback >parameter 4-57 Warning Feedback High.	Relay 123 active
6	00000040	64	Torque Limit (A12)	Reserved	Torque limit (W12)	Reserved	Feedback low. Feedback <parameter 4-56 Warning Feedback Low.	Start prevented
7	00000080	128	Motor Th over (A11)	Reserved	Motor Th over (W11)	End of Curve	Output current high. Current >parameter 4-51 Warning Current High.	Control ready
8	00000100	256	Motor ETR Over (A10)	Reserved	Motor ETR over (W10)	Broken Belt	Output current low. Current <parameter 4-50 Warning Current Low.	Drive ready
9	00000200	512	Inverter Overld. (A9)	Reserved	Inverter Overld (W9)	Reserved	Output freq high. Speed >parameter 4-53 Warning Speed High.	Quick stop
10	00000400	1024	DC under Volt (A8)	Reserved	DC under Volt (W8)		Output freq low. Speed <parameter 4-52 Warning Speed Low.	DC Brake
11	00000800	2048	DC over Volt (A7)	Reserved	DC over Volt (W7)		Brake check OK. Brake test NOT OK.	Stop
12	00001000	4096	Short Circuit (A16)	Reserved	DC Voltage Low (W6)	Reserved	Braking maximum, brake power >brake power limit (parameter 2-12 Brake Power Limit (kW)).	Standby
13	00002000	8192	Inrush Fault (A33)	Reserved	DC Voltage High (W5)		Braking.	Freeze output request

Bit	Hex	Dec	Alarm word	Alarm word 2	Warning word	Warning word 2	Extended status word	Extended status word 2
Alarm word extended status word								
14	0000400 0	16384	Mains ph. Loss (A4)	Reserved	Mains ph. Loss (W4)		Out of speed range.	Freeze output
15	0000800 0	32768	AMA Not OK	Reserved	No Motor (W3)		OVC active.	Jog request
16	0001000 0	65536	Live Zero Error (A2)	Reserved	Live Zero Error (W2)		AC brake.	Jog
17	0002000 0	131072	Internal Fault (A38)	KTY error	10V Low (W1)	KTY Warn	Password timelock number of allowed password trials exceeded, timelock active.	Start request
18	0004000 0	262144	Brake Overload (A26)	Fans error	Brake Overload (W26)	Fans Warn	Password protection. <i>Parameter 0-61 Access to Main Menu w/o Password = [3] Bus: Read only, or [4] Bus: No access, or [6] All: No access.</i>	Start
19	0008000 0	524288	U phase loss (A30)	ECB error	Brake Resistor (W25)	ECB Warn	Reference high. Reference >parameter 4-55 Warning Reference High.	Start applied
20	0010000 0	1048576	V phase loss (A31)	Reserved	Brake IGBT (W27)	Reserved	Reference low. Reference <parameter 4-54 Warning Reference Low.	Start delay
21	0020000 0	2097152	W phase loss (A32)	Reserved	Speed Limit (W49)	Reserved	Local reference. <i>Parameter 3-13 Reference Site = [1] Remote.</i> [Auto On] key is pressed and auto-on is active.	Sleep
22	0040000 0	4194304	Fieldbus Fault (A34)	Reserved	Fieldbus Fault (W34)	Reserved	Protection mode.	Sleep boost
23	0080000 0	8388608	24 V Supply Low (A47)	Reserved	24V Supply Low (W47)	Reserved	Unused.	Running
24	0100000 0	16777216	Mains Failure (A36)	Reserved	Mains Failure (W36)	Reserved	Unused.	Bypass
25	0200000 0	33554432	1.8 V Supply Low (A48)	Reserved	Current Limit (W59)	Reserved	Unused.	Emergency mode
26	0400000 0	67108864	Brake Resistor (A25)	Reserved	Low Temp (W66)	Reserved	Unused.	Reserved
27	0800000 0	134217728	Brake IGBT (A27)	Reserved	Voltage Limit (W64)	Reserved	Unused.	Reserved

Bit	Hex	Dec	Alarm word	Alarm word 2	Warning word	Warning word 2	Extended status word	Extended status word 2
Alarm word extended status word								
28	10000000 0	2684354 56	Option Change (A67)	Reserved	Encoder loss (W90)	Reserved	Unused.	Reserved
29	20000000 0	5368709 12	Drive Initialized(A80)	Feedback Fault (A61, A90)	Feedback Fault (W61, W90)		Unused.	Reserved
30	40000000 0	1073741 824	Safe Torque Off (A68)	PTC 1 Safe Stop (A71)	Safe Torque Off (W68)	PTC 1 Safe Torque Off (W71)	Unused.	Reserved
31	80000000 0	2147483 648	Mech. brake low (A63)	Dangerous Failure (A72)	Extended Status Word		Unused.	Reserved

Table 5.3 Description of Alarm Word, Warning Word, and Extended Status Word

The alarm words, warning words, and extended status words can be read out via fieldbus or optional fieldbus for diagnosis. See also *parameter 16-94 Ext. Status Word*.

Index

A

Abbreviation..... 7

Additional resources..... 4

Advanced minimum speed monitoring..... 58, 59

Advanced motor data..... 49

Alarm..... 299

Alarm log..... 152

Analog I/O option..... 229, 293

Analog output X30/8..... 101

Application
 functions..... 289
 Deragging..... 250
 Flow confirmation..... 254
 Submersible pump..... 58

Auto derate..... 144

Automatic energy optimization..... 142

Auto-tuning..... 173

B

Brake
 energy functions..... 65
 power..... 5
 Brakes..... 267
 DC brake..... 64

Break-away torque..... 5

Bypass option..... 297

C

CAN fieldbus..... 277

Cascade controller..... 216, 292

Clock setting..... 37

Closed loop..... 166, 286, 287

Coast..... 4, 17, 250

Communication..... 274

Comparator..... 121

Configuration..... 106

Control cable..... 11

Cooling..... 61

Current limit control..... 142

D

Data log settings..... 147

Data readout..... 156, 283

Data readout 2..... 285

Default settings..... 262

DeviceNet..... 114

Diagnosis..... 161

Discharge time..... 8

Display line large..... 33

Display line small..... 33

Display mode..... 18

Dry pump function..... 189

E

Emergency mode..... 211

End of curve..... 195

Energy log..... 205

ETR..... 157

Extended CL autotuning..... 178

F

Feedback..... 166, 171

Fieldbus jog..... 113

Flow compensation..... 197

Freeze output..... 4

Frequency converter identification..... 153

Frequency converter information..... 147, 281

Frequency converter status..... 157

G

General settings..... 40, 104

General status..... 156

Graphical display..... 13

H

High voltage..... 8

I

Identification, frequency converter..... 153

Indexed parameter..... 22

Indicator light..... 14

Initialization..... 25

Inputs		Motor	
Analog I/O mode.....	94	Load/motor.....	265
Analog in/out.....	272	data.....	43, 47
Analog input.....	5, 96, 97	limit.....	74
Analog input scaling value.....	232	protection.....	59
Analog input X30/11.....	97	speed, rated.....	5
Digital I/O mode.....	79	speed, synchronous.....	5
Digital in/out.....	270	status.....	156
Sensor input option.....	297	temperature.....	59
Inverter switching.....	137	PM motor.....	43, 45
J		N	
Jog.....	4	Numerical local control panel.....	23
L		O	
Language package.....	27	Operating data.....	147
LCP.....	4, 6, 13, 17, 23, 254	Operating mode.....	28
LCP copy/save.....	36	Operation/display.....	263
LCP custom readout.....	33	Overload	
LCP display.....	30	Inverter overload, no trip.....	144
LCP key.....	24	Overload.....	58
LED.....	13, 14	Override limit.....	240
Limit/warning.....	269	 	
Load dependent settings.....	55	P	
Load sharing.....	8	Parameter access.....	116
Local reference.....	28, 71	Parameter information.....	155
Log.....	151	Parameter option.....	262
Logic rule.....	126	Parameter set-up.....	19, 26
Low-power detection.....	188	Password.....	37
Low-speed detection.....	188	PID Auto-tuning.....	173
 		PID basic settings.....	175
M		PID controller.....	176
Main menu.....	15, 19, 21, 26	Pipe fill function.....	249
Main reactance.....	48, 49	Pipe fill mode.....	249
Mains		Port diagnostics.....	113
supply.....	7	Potentiometer reference.....	12
Mains on/off.....	137	Pre-lube.....	253
Mains RFI filter circuit.....	143	PROFIBUS.....	275
Maintenance log.....	163	Protection mode.....	9
MCB 114.....	259	Pulse start/stop.....	12
		Q	
		Quick menu.....	14, 15, 19, 26
		R	
		Ramp.....	71, 72
		RCD.....	6

Reference..... 158
 Reference limit..... 68
 Reference/ramps..... 268
 Relay output..... 84
 Reset..... 17
 Rs flip flops..... 123

S

Serial communication..... 5
 Shielded..... 11
 Short cycle protection..... 196
 Sleep mode..... 192
 Smart logic..... 278
 Smart logic control..... 251
 Special features..... 297
 Special functions..... 279
 Speed bypass..... 77
 Speed up/down..... 12
 Spin time..... 239
 Start adjustments..... 57
 Start delay..... 57
 Start function..... 57
 Start/stop..... 11
 Stator leakage reactance..... 48, 49
 Status..... 14
 Status message..... 13
 Status word..... 250
 Stop adjustments..... 58
 Symbol..... 7

T

Terminals
 Terminal X30/11..... 97
 Terminal X30/12..... 97
 Thermal load..... 54, 157
 Thermistor
 Thermistor..... 6
 Thermistor..... 59
 Timed actions..... 200, 291
 Timer..... 126
 Trip
 Trip..... 59, 254
 reset..... 140

U

U/f characteristic..... 54
 Unintended start..... 8

V

VVC+..... 7

W

Warning..... 299
 Water application functions..... 249, 295



Danfoss Drives

4401 N. Bell School Rd.
Loves Park IL 61111 USA
Phone: 1-888-DANFOSS
Fax: 1-815-639-8000
www.danfossdrives.com

Danfoss Drives

8800 W. Bradley Rd.
Milwaukee, WI 53224 USA
Phone: 1-888-DANFOSS
Fax: 1-414-355-6117
www.danfossdrives.com

.....
Danfoss shall not be responsible for any errors in catalogs, brochures or other printed material. Danfoss reserves the right to alter its products at any time without notice, provided that alterations to products already on order shall not require material changes in specifications previously agreed upon by Danfoss and the Purchaser. All trademarks in this material are property of the respective companies. Danfoss and the Danfoss logotype are trademarks of Danfoss A/S. All rights reserved.
.....

Danfoss A/S
Ulsnaes 1
DK-6300 Graasten
vlt-drives.danfoss.com

