

- CODE**
3132052
3132053
31320535
31320E2
31320E3
31320E35
3132152
3132153
31321535
3132452
3132453
31324535
31324E2
31324E3
31324E35
3132552
3132553
31325535

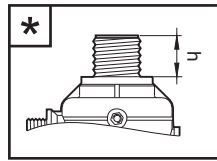

(h = 24 mm / G 1" 1/4)* 3142050.010
(h = 38 mm / G 1" 1/4)* 3142150.010

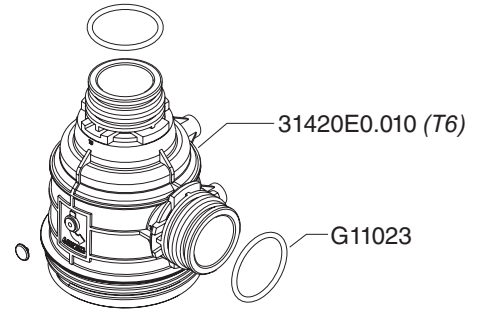
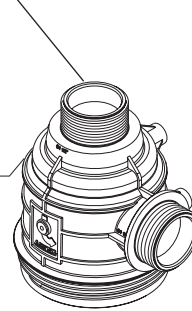

(rosso / red) 3102002.012
(blu / blue) 3102003.012
(giallo / yellow) 31020035.012

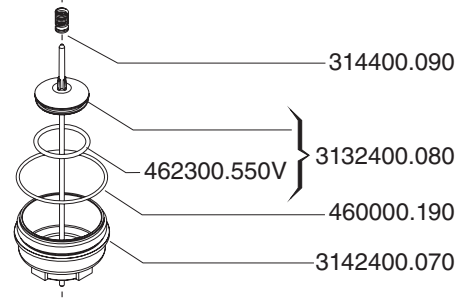

31420E0.010 (T6)
G11023



314400.090
462300.550V } 3132400.080
460000.190
3142400.070

colore / color ISO 19732	MESH	codice / code
 rosso / red	32	3182002.030
 blu / blue	50	3182003.030
 giallo / yellow	80	31820035.030

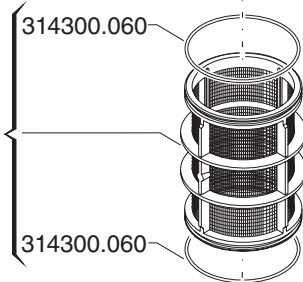

314300.060
314300.060

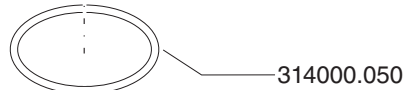

314000.050

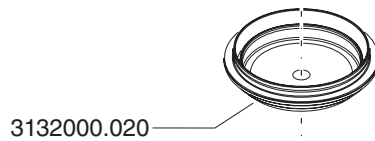

3132000.020

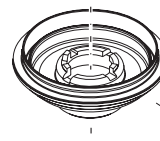

3132400.020

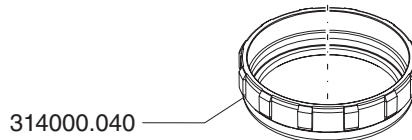

314000.040

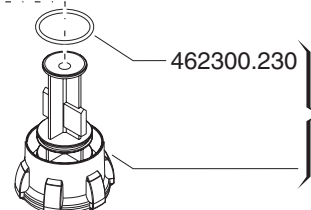

462300.230 } 3142400.060